

**TPC Benchmark[®] C
Full Disclosure Report
for
Dell PowerEdge 6600
Using
Microsoft SQL Server 2000 8.0 Enterprise
Edition
and
Microsoft Windows .NET Enterprise Server**

First Edition
Submitted for Review
Jan 06, 2003

First Printing, JAN 06, 2003

Dell believes that the information included in this document is accurate as of the publication date. The information in this document is subject to change without notice. Furthermore, Dell is not responsible for any errors contained within this document.

The pricing information given in this FDR is accurate as of the publication date, JAN 06, 2003 and is generally available.

Benchmark results are highly dependent upon workload, specific application requirements, and system design and implementation. Relative system performance will vary as a result for these and other factors. Therefore, TPC Benchmark C should not be used as a substitute for a specific customer application benchmark when critical capacity planning and/or product evaluation decisions are contemplated.

All performance data contained in this report were obtained in a rigorously controlled environment. Actual performance experienced by a particular customer may vary due to differences in system layout and configuration, hardware and/or software revision levels, and background system activity. The content of this document is for informational purposes only.

Copyright 2000 Dell

All rights reserved. Permission is hereby granted to reproduce this document in whole or in part provided the copyright notice printed above is set forth in full text or on the title page of each item reproduced.

PowerEdge is a trademark of Dell.

Microsoft, Windows 2000 and SQL Server are registered trademarks of Microsoft Corporation.

TPC Benchmark, TPC-C and tpmC are registered trademarks of the Transaction Processing Performance Council.

Intel and Pentium are registered trademarks of Intel Corporation.

Other product names mentioned in this document may be trademarks and/or registered trademarks of their respective companies.

Abstract

Overview

This report documents the methodology and results of the TPC Benchmark™ C test conducted on Dell PowerEdge 6600. The tests were run in a client/server configuration using Eight PowerEdge 1500's as clients. The operating system used for the benchmark was Microsoft Windows .NET Enterprise Server on the database server and Microsoft Windows 2000 Server on the clients. The database was Microsoft SQL Server 2000 Enterprise Edition. Microsoft COM+ provided the database connection queues. All tests were done in compliance with Revision 5.0 of the Transaction Processing Council's TPC Benchmark™ C Standard Specification. Two standard TPC Benchmark™ C metrics, transactions per second (tpmC) and price per tpmC (\$/tpmC) are reported and referred to in this document. The results from the tests are summarized below.

Hardware	Software	Total System Cost	tpmC	\$/tpmC	Availability Date
Dell PowerEdge 6600	Microsoft Windows .NET Enterprise Server Windows 2000 Server SQL Server 2000 Enterprise Edition	\$365,317	71,313.19	\$5.13	Mar 31, 2003

Auditor

The results of the benchmark and test methodology used to produce the results were audited by Lorna Livingtree of Performance Metrics and have fully met the TPC-C rev 5.0 specifications.

Additional copies of this Full Disclosure Report can be obtained from either the Transaction Processing Performance Council or Dell at the following address:

Transaction Processing Performance Council (TPC)
c/o Administrator, TPC
Presidio of San Francisco
Bldg 572B Rucker St.
San Francisco, CA 94129-0920
Phone: (415) 561-6272, fax 415-561 6120
www.tpc.org

or

Dell
1 Dell Drive
Round Rock, TX 78682
Attention: Mike Molloy



PowerEdge 6600

Client/Server w/8 PE1600 Front Ends

TPC-C Rev 5.0
Report Date
Jan 06, 2003

Total System Cost	TPC-C Throughput	Price/Performance	Availability Date
\$365,317	71,313.19 tpmC	\$5.13/ tpmC	Mar 31, 2003

Processors	Database Manager	OS	Other Software	Number of Users
4 x Intel Xeon™ MP Processors 2.0 GHz 2MB L2 Cache	Microsoft SQL Server 2000 Enterprise Edition SP3	Microsoft Windows .NET Enterprise Server	Windows 2000 Server w/ COM+ Internet Information Server 5.0 Microsoft Visual C++	58,000

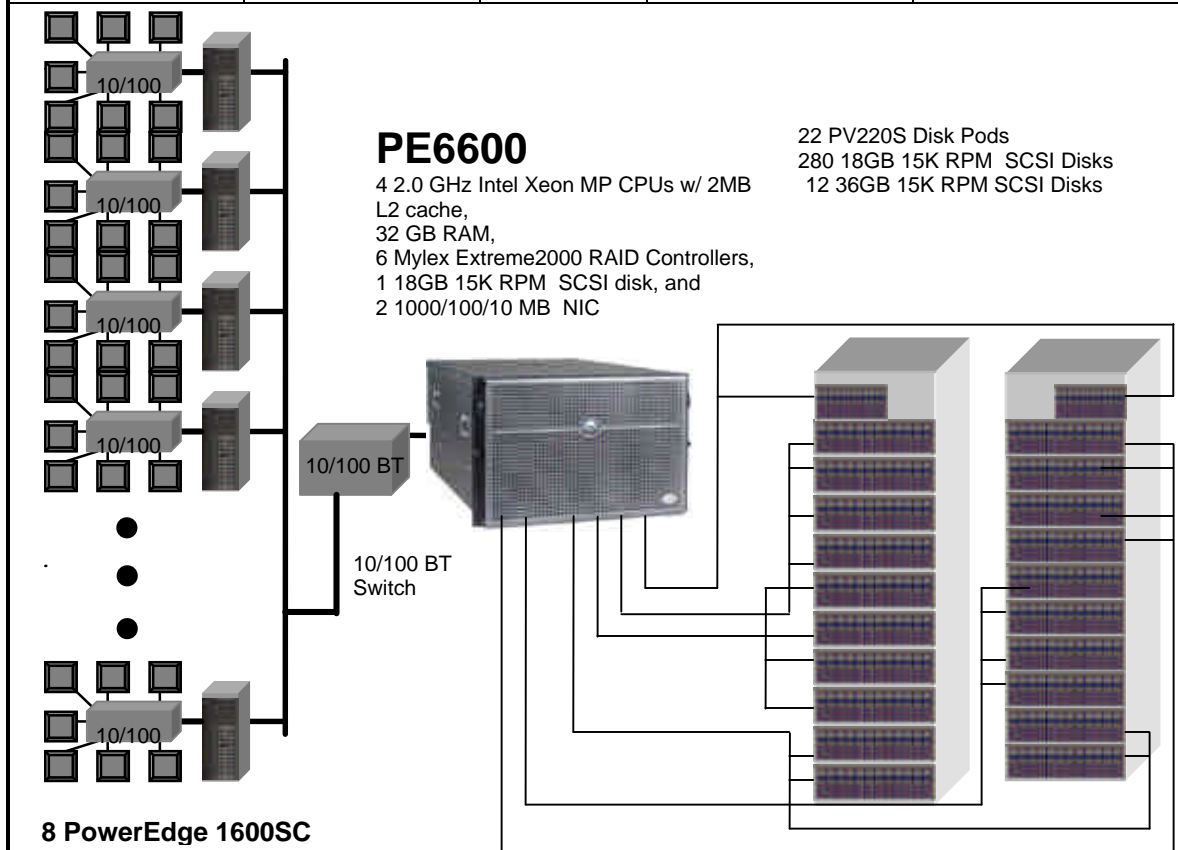

System Component	Server		Each Client	
Processors	4	Intel Xeon MP @ 2.0GHz	1	Pentium® III w/ 512 KB L2
Cache		2MB cache	8 clients @	1.13 GHz
Memory		32,768 MB		512 MB
Disk Controllers	6	Mylex ExtremeRAID 2000	1	Adaptec On-Board
	1	Adaptec On-Board		
Disk Drives	280	18 GB SCSI	1	18 GB
	12	36 GB SCSI		
Total Storage		5,126.03 GB		18 GB
Other	2	1GB NIC	2	10/100MB BT NIC
	1	CD-ROM	1	
	1	DAT		

Description	Part Number	Third Party	Unit Price	Qty	Extended Price	3 yr. Maint. Price
		Brand Pricing				
Server Hardware						
Dell PowerEdge 6600	220-1828		1	8,126	8,126	1,299
Intel Xeon MP 2.0GHz / 1MB L2 - 4 processors	311-2348		1	14,999	14,999	-
32 GB,DDR, 16 x 2048MB DIMMS	311-2352		1	71,000	71,000	-
18 GB U160M SCSI 10K RPM Hard Drive	340-1937		1	249	249	-
Tape Backup Unit	340-6507		1	699	699	-
Dell 15" Monitor	320-0960		1	149	149	-
Extreme RAID 2000 PCI SCSI 4 channel RAID controller***	08P3834	Mylex	3	1,228	9,824	-
				Subtotal	105,046	1,299
PowerVault Disk Subsystem						
PV220S, U3 SCSI, PS, Rack mount	220-4476, etc.		1	2,756	60,632	13,200
SCSI Cables	310-0679		1	99	1,089	-
18 GB SCSI 15K RPM Hard Drive *	340-6865		1	399	111,720	-
36 GB SCSI 15K RPM Hard Drive *	340-3088		1	399	4,788	-
42U Rack	220-4492		1	1,264	2,528	-
				Subtotal	180,757	13,200
Server Software						
SQL Server 2000 Ent Edition, Per processor licensing **	810-00846	Microsoft	2	16,541	66,164	5,850
Windows .NET Enterprise Server 2003 **		Microsoft	2	2,699	2,699	-
				Subtotal	68,863	5,850
Client Hardware						
Dell PowerEdge 1600SC, 1.8 GHz Pentium III w/ 512KB L2*****	221-0916		1	1,467	11,736	6,384
512MB RAM, 4 DIMMs	311-1833		1	408	3,264	-
18GB,U160,10K, SCSI Hard Drive,	340-9450		1	249	1,992	-
Ether Express PRO 100+ Ethernet Adapter	430-0369	Intel	1	59	472	-
Dell 15" Monitor	320-0960		1	149	1,192	-
				Subtotal	18,656	6,384
Client Software						
Windows 2000 Server, 5 Client Licenses **	C11-00821	Microsoft	2	738	5,904	-
Visual C++ .Net Standard **	254-00170	Microsoft	2	109	109	-
				Subtotal	6,013	-
User Connectivity						
16 Port Ethernet Switch	220-1499	Dell	1	119	119	65
				Subtotal	119	105
				Other Discounts	(40,871)	-
				Total	338,583	26,838

<p>Notes: * Maint. included in PowerVault 220S disk pod or PV650F/630F fibre channel disk pod ** All Microsoft maintenance is covered by the maintenance costs of Microsoft SQL Server *** 10% or minimum 2 spares are added in place of onsite service (products have a five year return-to-vendor warranty) Pricing: 1 - Dell 2 - Microsoft 3 - Computer Giants **** Discount based upon total system cost as purchased by a regular customer. Pricing may be verified by calling 1-800-BUY-DELL referencing quote numbers 99098172 as complex quotes. ***** Substitutes for PE1500SC. Meets TPC Substitution requirements</p> <p>Audited by Lorna Livingtree, Performance Metrics Inc.</p>	<p>Three-Year Cost of Ownership: \$365,421</p> <p>tpmC Rating: 71313.19</p> <p>\$/tpmC: 5.13</p>
--------------------------------------------------------------------------------------------------------------------------------------------------------------------------------------------------------------------------------------------------------------------------------------------------------------------------------------------------------------------------------------------------------------------------------------------------------------------------------------------------------------------------------------------------------------------------------------------------------------------------------------------------------------------------------------------------------------------------	-----------------------------------------------------------------------------------------------------------------------

Prices used in TPC benchmarks reflect the actual prices a customer would pay for a one-time purchase of the stated components. Individually negotiated discounts are not permitted. Special prices based on assumptions about past or future purchases are not permitted. All discounts reflect standard pricing policies for the listed components. For complete details, see the pricing sections of the TPC benchmark specifications. If you find that the stated prices are not available according to these items, please inform the TPC at pricing@tpc.org.

MQTh, computed Maximum Qualified Throughput

71,313.19
tpmC

Response Times (in seconds)

	Average	90th	Max
- Neworder	0.73	1.12	6.71
- Payment	0.60	0.98	4.91
- Order Status	0.62	0.99	5.95
- Delivery (interactive portion)	0.19	0.41	1.42
- Delivery (deferred portion)	0.29	0.39	1.34
- Stock-Level	1.28	1.75	4.57
- Menu	0.19	0.41	1.41

Response time delay added for emulated components

Menu 0.1
Resp 0.1

Transaction Mix, in percent of total transactions

- New-Order	44.85%
- Payment	43.04 %
- Order-Status	4.03 %
- Delivery	4.04 %
- Stock-Level	4.04 %

Keying/Think Times (in seconds),

	Min		Average		Max	
- New-Order	18.01	0.0	18.02	12.04	18.17	120.45
- Payment	3.01	0.0	3.02	12.03	3.17	120.45
- Order-Status	2.01	0.0	2.02	10.03	2.16	100.42
- Delivery	2.01	0.0	2.02	5.05	2.16	50.44
- Stock-Level	2.01	0.0	2.02	5.05	2.18	50.42

Test Duration

- Ramp-up time	15 minutes
- Measurement interval	120 minutes
- Number of checkpoints	4
- Checkpoint interval	30 minutes
- Number of transactions (all types) completed in measurement interval	19,853,145

Table of Contents

ABSTRACT	1
OVERVIEW.....	1
AUDITOR	1
TABLE OF CONTENTS	1
INTRODUCTION	5
DOCUMENT STRUCTURE	5
BENCHMARK OVERVIEW	5
SYSTEM OVERVIEW	6
GENERAL ITEMS	7
TEST SPONSOR	7
APPLICATION CODE AND DEFINITION STATEMENTS	7
PARAMETER SETTINGS.....	7
CONFIGURATION DIAGRAMS	8
CLAUSE 1 -- LOGICAL DATABASE DESIGN RELATED ITEMS	11
TABLE DEFINITIONS.....	11
PHYSICAL ORGANIZATION OF THE DATABASE	11
INSERT AND DELETE OPERATIONS	11
HORIZONTAL AND VERTICAL PARTITIONING	11
REPLICATION.....	11
TABLE ATTRIBUTES.....	11
CLAUSE 2 -- TRANSACTION AND TERMINAL PROFILES RELATED ITEMS	12
RANDOM NUMBER GENERATION	12
SCREEN LAYOUT	12
TERMINAL VERIFICATION	12
INTELLIGENT TERMINALS	12
TRANSACTION PROFILES	12
TRANSACTION MIX	13
DEFERRED DELIVERY MECHANISM.....	13
CLAUSE 3 -- TRANSACTION AND SYSTEM PROPERTIES RELATED ITEMS	14
ACID TESTS	14
<i>Atomicity</i>	14
<i>Consistency</i>	14
<i>Isolation</i>	14
<i>Durability</i>	15
CLAUSE 4 -- SCALING AND DATABASE POPULATION RELATED ITEMS	17
TABLE CARDINALITY.....	17
CONSTANT VALUES.....	17
DATA DISTRIBUTION.....	18
PARTITION MAPPING	22
60 DAY SPACE CALCULATION	22
CLAUSE 5 -- PERFORMANCE METRICS AND RESPONSE TIME RELATED ITEMS	23

MEASURED TPMC	23
RESPONSE TIMES	23
THINK TIMES & KEY TIMES	23
RESPONSE TIME DISTRIBUTION CURVES	24
NEW-ORDER RESPONSE TIME VS. THROUGHPUT GRAPH	27
NEW-ORDER THINK TIME DISTRIBUTION GRAPH	28
STEADY-STATE GRAPH	28
STEADY-STATE METHODOLOGY	29
WORK PERFORMED DURING STEADY STATE	29
REPRODUCIBILITY METHODOLOGY	ERROR! BOOKMARK NOT DEFINED.
MEASUREMENT INTERVAL	29
TRANSACTION MIX	30
OTHER METRICS	30
CHECKPOINTS	ERROR! BOOKMARK NOT DEFINED.
CLAUSE 6 -- SUT, DRIVER, AND COMMUNICATION DEFINITION RELATED ITEMS	32
RTE PARAMETERS	32
EMULATED COMPONENTS	32
BENCHMARKED AND TARGETED SYSTEM CONFIGURATION DIAGRAMS	32
NETWORK CONFIGURATION	32
NETWORK BANDWIDTH	32
OPERATOR INTERVENTION	33
CLAUSE 7 -- PRICING RELATED ITEMS	34
HARDWARE AND SOFTWARE LIST	34
AVAILABILITY DATE	34
MEASURED TPMC	34
COUNTRY SPECIFIC PRICING	34
USAGE PRICING	34
SYSTEM PRICING	35
CLAUSE 9 -- AUDIT RELATED ITEMS	36
AUDITOR	36
AVAILABILITY OF THE FULL DISCLOSURE REPORT	36
AUDITOR'S LETTER OF ATTESTATION	37
APPENDIX A - APPLICATION SOURCE CODE	39
TPCC.DLL ISAPI DLL SOURCE CODE	39
<i>isapi_dll/src/tpcc.def</i>	39
<i>isapi_dll/src/tpcc.h</i>	39
<i>isapi_dll/src/tpcc.rc</i>	41
<i>isapi_dll/src/tpcc.cpp</i>	42
<i>isapi_dll/src/resource.h</i>	63
<i>common/src/ReadRegistry.cpp</i>	63
<i>common/src/ReadRegistry.h</i>	64
<i>common/src/error.h</i>	65
<i>common/src/trans.h</i>	67
<i>common/src/txn_base.h</i>	68
<i>db_dblib_dll/src/tpcc_dblib.cpp</i>	69
<i>db_dblib_dll/src/tpcc_dblib.h</i>	78
<i>tm_com_dll/src/tpcc_com.cpp</i>	79
<i>tm_com_dll/src/tpcc_com.h</i>	81
<i>tpcc_com_all/src/methods.h</i>	82
<i>tpcc_com_all/src/resource.h</i>	85

<i>tpcc_com_all/src/tpcc_com_all.cpp</i>	85
<i>tpcc_com_all/src/tpcc_com_all.def</i>	90
<i>tpcc_com_all/src/tpcc_com_all.h</i>	90
<i>tpcc_com_all/src/tpcc_com_all.idl</i>	91
<i>tpcc_com_all/src/tpcc_com_all.rc</i>	92
<i>tpcc_com_all/src/tpcc_com_all.rgs</i>	93
<i>tpcc_com_all/src/tpcc_com_all_i.c</i>	93
<i>tpcc_com_all/src/tpcc_com_no.rgs</i>	95
<i>tpcc_com_all/src/tpcc_com_os.rgs</i>	95
<i>tpcc_com_all/src/tpcc_com_pay.rgs</i>	95
<i>tpcc_com_all/src/tpcc_com_ps.h</i>	96
<i>tpcc_com_all/src/tpcc_com_sl.rgs</i>	98
<i>tpcc_com_ps/src/dlldata.c</i>	98
<i>tpcc_com_ps/src/tpcc_com_ps.def</i>	99
<i>tpcc_com_ps/src/tpcc_com_ps.h</i>	99
<i>tpcc_com_ps/src/tpcc_com_ps.idl</i>	101
<i>tpcc_com_ps/src/tpcc_com_ps_i.c</i>	102
<i>tpcc_com_ps/src/tpcc_com_ps_p.c</i>	103
<i>common/txnlog/include/rtetime.h</i>	124
<i>common/txnlog/include/spinlock.h</i>	124
<i>common/txnlog/include/txnlog.h</i>	125
APPENDIX B - DATABASE DESIGN	129
BUILD SCRIPTS	129
<i>setup.cmd</i>	129
<i>createdb.sql</i>	130
<i>tables.sql</i>	131
<i>idxcuscl.sql</i>	132
<i>idxcusnc.sql</i>	132
<i>idxdiscl.sql</i>	133
<i>idxitmcl.sql</i>	133
<i>idxnodcl.sql</i>	133
<i>idxodlcl.sql</i>	134
<i>idxordcl.sql</i>	134
<i>idxstkcl.sql</i>	134
<i>idxwarcl.sql</i>	134
<i>dbopt1.sql</i>	135
<i>dbopt2.sql</i>	135
<i>dbopt3.sql</i>	136
<i>backup.sql</i>	136
<i>restore.sql</i>	136
STORED PROCEDURES	137
<i>neword.sql</i>	137
<i>payment.sql</i>	139
<i>ordstat.sql</i>	141
<i>delivery.sql</i>	142
<i>stocklev.sql</i>	143
LOADER SOURCE CODE	143
<i>tpcc.h</i>	143
<i>tpccldr.c</i>	145
<i>getargs.c</i>	165
<i>random.c</i>	166
<i>strings.c</i>	168
<i>time.c</i>	171

APPENDIX C - TUNABLE PARAMETERS	172
SERVER CONFIGURATION PARAMETERS.....	172
Microsoft Windows .NET Enterprise Server Parameters.....	172
Microsoft Windows .NET Enterprise Server Configuration.....	172
Microsoft SQL Server Version 7.0 Startup Parameters.....	172
Microsoft SQL Server Stack Size	173
Mylex Device Drivers and Firmware	173
Mylex Registry Key	Error! Bookmark not defined.
Qlogic Device Driver	Error! Bookmark not defined.
Giganet Registry Key	Error! Bookmark not defined.
Microsoft SQL Server 7.0 Configuration Parameters	173
Windows .NET Enterprise Server System Information Report For PE6400.....	174
CLIENT CONFIGURATION PARAMETERS	174
COM+ Settings.....	243
TPCC Application Registry Parameters.....	243
Microsoft Internet Information Server Registry Parameters	243
World Wide Web Service Registry Parameters.....	243
Microsoft Windows 2000 Server System Information Report for PE1300.....	245
RTE INPUT PARAMETERS	289
BenchCraft Configuration File.....	289
APPENDIX D – DISK STORAGE.....	301
60 DAY SPACE	ERROR! BOOKMARK NOT DEFINED.
APPENDIX E - PRICE QUOTATIONS	301

Introduction

Document Structure

The TPC Benchmark C Standard Specification Revision 5.0, written and approved by the Transaction Processing Performance Council (TPC), determines the contents of this report. The format of this report is based on this specification. Most sections of this report begin with the specification requirements printed in italic type, immediately followed by the detail in plain type of how Dell complied with the specification. Where extensive listings are required (such as listing of code), a note is included which references an appendix containing the listing.

Benchmark Overview

TPC Benchmark™ C (TPC-C) is an OLTP workload. It is a mixture of read-only and update intensive transactions that simulate the activities found in complex OLTP application environments. It does so by exercising a breadth of system components associated with such environments, which are characterized by:

- The simultaneous execution of multiple transaction types that span a breadth of complexity
- On-line and deferred transaction execution modes
- Multiple on-line terminal sessions
- Moderate system and application execution time
- Significant disk input/output
- Transaction integrity (ACID properties)
- Non-uniform distribution of data access through primary and secondary keys
- Databases consisting of many tables with a wide variety of sizes, attributes, and relationships
- Contention on data access and update

The performance metric reported by TPC-C is a "business throughput" measuring the number of orders processed per minute. Multiple transactions are used to simulate the business activity of processing an order, and each transaction is subject to a response time constraint.

The performance metric for this benchmark is expressed in transactions-per-minute-C (tpmC). To be compliant with the TPC-C standard, all references to tpmC results must include the tpmC rate, the associated price-per-tpmC, and the availability date of the priced configuration.

Although these specifications express implementation in terms of a relational data model with conventional locking scheme, the database may be implemented using any commercially available database management system (DBMS), database server, file system, or other data repository that provides a functionally equivalent implementation. The terms "table", "row", and "column" are used in this document only as examples of logical data structures.

TPC-C uses terminology and metrics that are similar to other benchmarks, originated by the TPC or others. Such similarity in terminology does not in any way imply that TPC-C results are comparable to other benchmarks. The only benchmark results comparable to TPC-C are other TPC-C results conformant with the same revision.

Despite the fact that this benchmark offers a rich environment that emulates many OLTP applications, this benchmark does not reflect the entire range of OLTP requirements. In addition, the extent to which a customer can achieve the results reported by a vendor is highly dependent on how closely TPC-C approximates the customer application. The relative performance of

systems derived from this benchmark does not necessarily hold for other workloads or environments. Extrapolations to any other environment are not recommended.

Benchmark results are highly dependent upon workload, specific application requirements, and systems design and implementation. Relative system performance will vary as a result of these and other factors. Therefore, TPC-C should not be used as a substitute for a specific customer application benchmarking when critical capacity planning and/or product evaluation decisions are contemplated.

System Overview

The hardware configuration used in this TPC-C test is a Dell PowerEdge 6600 server driven by eight Dell PowerEdge 1500 clients. The clients and server are networked together via a 100 Base T switch. Ten remote terminal emulator (RTE) systems (PowerEdge 2200's) emulate 58,000 users executing the standard TPC-C workload. The RTE's are connected to the eight clients through 10/100BaseT switches. Each switch connects to one client machine at 100BaseT and to the RTE machines at 10BaseT, half duplex. Microsoft Windows .NET Enterprise Server was the operating system used on the server. Microsoft Windows 2000 Server was used on the clients. Microsoft SQL Server 2000 Enterprise Edition was the database on the server machine.

The PowerEdge 6600 motherboard uses the ServerWorks Grand Champion High End chipset and can hold up to four Pentium® 4 processors (2.0 GHz with 2MB L2 cache each). The system has 10 PCI-X 64-bit/100MHz I/O slots and a single legacy 32-bit/33MHz PCI slot. The measured configuration used 32Gbytes of DDR RAM, which was achieved by using 16 2048Mbyte DIMMs.

The PowerEdge 6600 has an integrated Adaptec AIC-7892 U160 SCSI controller to which was attached one 18GB disk drive containing the operating system. In addition, 6 Mylex ExtremeRAID 2000 4-channel RAID controllers were installed in six PCI-X slots and connected to 22 PowerVault 220S disk pods, which can hold 14 disks each. Five ExtremeRAID 2000 was connected to 20 PV220 disk pods enclosing a total of 280 18GB SCSI disks, containing database data. The last ExtremeRAID 2000 was connected two PV220 disk pods enclosing 12 36Gb SCSI drives mirrored using RAID10, configured for transaction log data. There were four empty PCI-X slots. The legacy 33MHz PCI slot was also empty.

Each client had a single 1.13GHz Pentium® III processor with 512 Kbytes of L2 cache. Each client had 512 Mbytes of RAM, one 9 GB hard disk, one intergrated Intel Ether Express Pro100+ PCI Ethernet adapter and one Intel Pro 100 Network Interface Card. On each client the Intel Ethernet adapter was connected to the RTE machines through a 10/100 BaseT switch and the Intel Pro NIC was connected to the Database Server through a 10/100 Base T switch. The eight clients were driven through a total of 40 network segments. 1450 emulated users were run on each network segment for a total of 58,000 emulated users. The network segments between the switches and RTEs were fixed at 10 Mbit/sec, half duplex.

General Items

Test Sponsor

A statement identifying the sponsor of the Benchmark and any other companies who have participated.

Dell was the test sponsor of this TPC Benchmark™ C.

Application Code and Definition Statements

The application program must be disclosed. This includes, but is not limited to, the code implementing the five transactions and the terminal input/output functions.

The application consists of the Microsoft Benchcraft Remote Terminal Emulator (RTE) program emulating a set of users entering TPC-C transactions through web browsers, and communicating with Client machines running the Microsoft Internet Information Server (IIS) web server. The Client machines use the COM+ transaction monitor to communicate with the database server machine.

On each Client machine IIS loads a custom Microsoft Internet Information Server Application Programming Interface dynamic link library (ISAPI DLL) application program that communicates with the emulated web browsers through the HTTP protocol and with the database server through the COM+ transaction monitor and the Microsoft DBLIB interface. The application supplies fill-in screens to the user for each transaction, then parses the data in each request, and makes a call on SQL Server through the COM+ layer, which manages a set of DBLIB connections to the database server. The resulting data is passed back to the application where it is formatted into HTML and sent back to the user's browser. The Delivery transaction is handled directly from the application to the database without the use of COM+.

The web Client code is listed in Appendix A.

Parameter Settings

Settings must be provided for all customer-tunable parameters and options which have been changed from the default found in actual products; including but not limited to:

- *Database options*
- *Recover/commit options*
- *Consistency/locking options*
- *System parameter, application parameters, and configuration parameters.*

This requirement can be satisfied by providing a full listing of all parameters and options.

Appendix C contains all the database, Windows .NET Enterprise Server, Windows 2000 Server, and Internet Information Service parameters used in this benchmark.

Appendix D contains the 60 day space calculations.

Configuration Diagrams

Diagrams of both the measured and priced system must be provided, accompanied by a description of the differences.

Figures 1 and 2 respectively show the measured and priced full client/server configurations. The system under test (SUT) in the measured system was identical to what was priced.

Figure 1: Measured Configuration

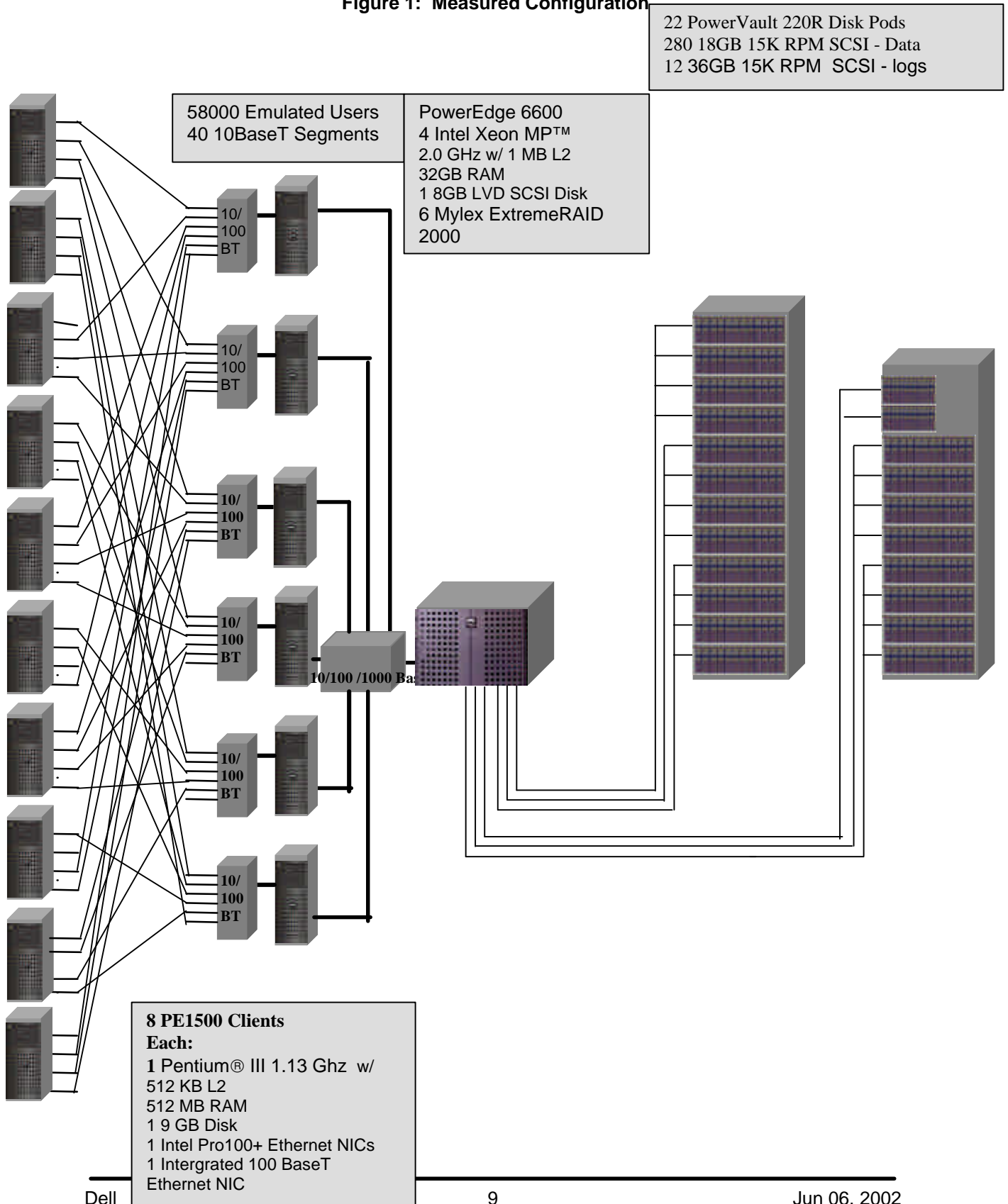
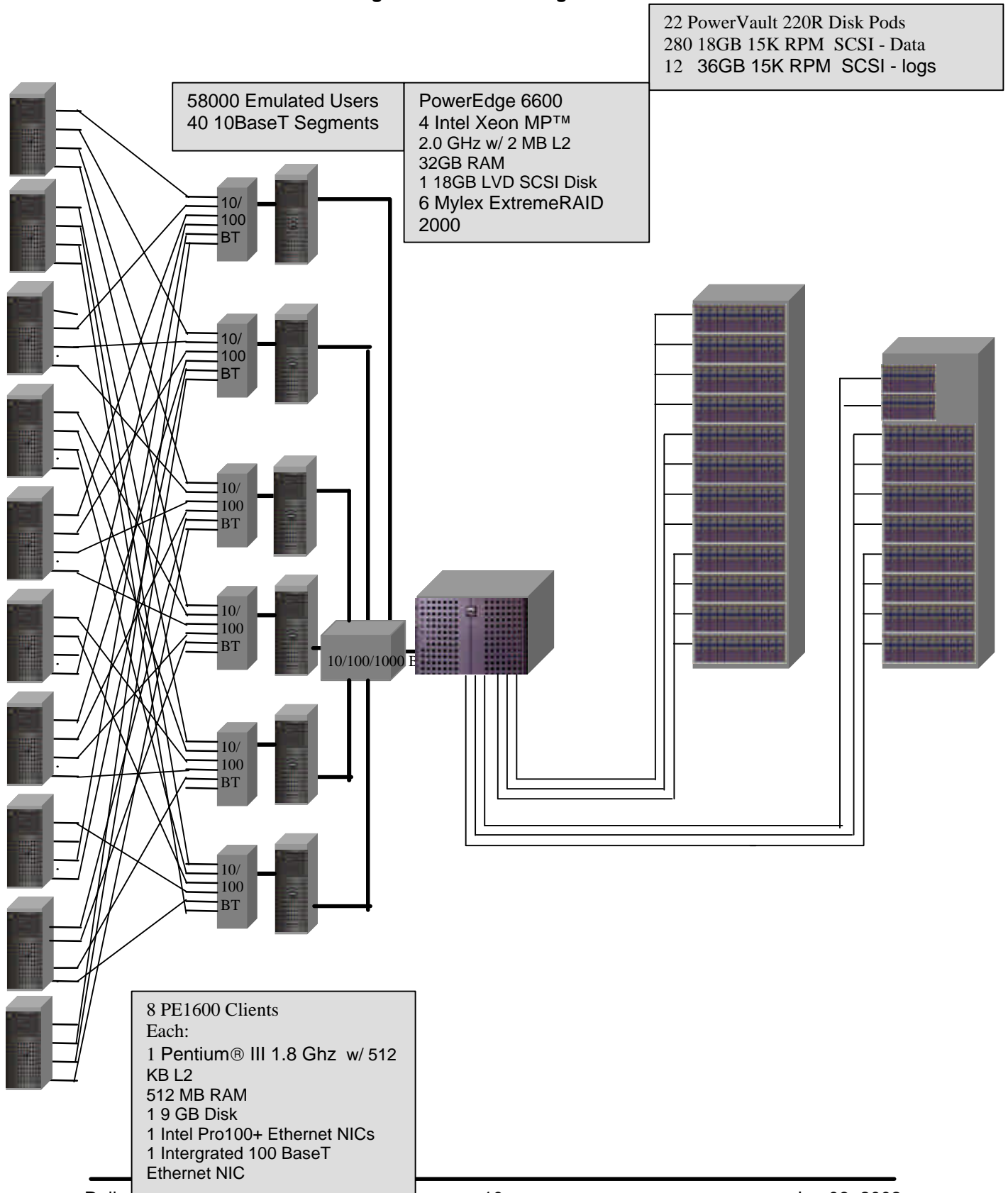

Figure 2: Priced Configuration



Clause 1 -- Logical Database Design Related Items

Table Definitions

Listings must be provided for all table definition statements and all other statements used to set-up the database. (8.1.2.1)

Appendix B contains the code used to define and load the database tables.

Physical Organization of the Database

The physical organization of tables and indices, within the database, must be disclosed. (8.1.2.2)

The measured configuration used 293 disk drives. The organization is shown in Table 5: Data Distribution.

Insert and Delete Operations

It must be ascertained that insert and/or delete operations to any of the tables can occur concurrently with the TPC-C transaction mix. Furthermore, any restriction in the SUT database implementation that precludes inserts beyond the limits defined in Clause 1.4.11 must be disclosed. This includes the maximum number of rows that can be inserted and the maximum key value for these new rows. (8.1.2.3)

Insert and delete functionality was fully operational during the benchmark.

Horizontal and Vertical Partitioning

While there are a few restrictions placed upon horizontal or vertical partitioning of tables and rows in the TPC-C benchmark (see Clause 1.6), any such partitioning must be disclosed. (8.1.2.4)

Partitioning was not used in this benchmark.

Replication

Replication of tables, if used, must be disclosed (see Clause 1.4.6). (8.1.2.5)

Replication was not used in this benchmark.

Table Attributes

Additional and/or duplicated attributes in any table must be disclosed along with a statement on the impact on performance (see Clause 1.4.7). (8.1.2.6)

No additional attributes were used in this benchmark.

Clause 2 -- Transaction and Terminal Profiles Related Items

Random Number Generation

The method of verification for the random number generation must be described. (8.1.3.1)

The random number generation was done internal to the Microsoft BenchCraft RTE program, which was audited independently.

Screen Layout

The actual layouts of the terminal input/output screens must be disclosed. (8.1.3.2)

The screen layouts are based on those in Clauses 2.4.3, 2.5.3, 2.6.3, 2.7.3, and 2.8.3 of the TPC-C Standard Specification. There are some very minor differences based on the fact that this is a web client implementation.

Terminal Verification

The method used to verify that the emulated terminals provide all the features described in Clause 2.2.2.4 must be explained. Although not specifically priced, the type and model of the terminals used for the demonstration in 8.1.3.3 must be disclosed and commercially available (including supporting software and maintenance). (8.1.3.3)

The terminal features were verified by allowing the auditor to manually execute each of the five transaction types, using Microsoft Internet Explorer version 3.0.

Intelligent Terminals

Any usage of presentation managers or intelligent terminals must be explained. (8.1.3.4)

Comment 1: *The intent of this clause is to describe any special manipulations performed by a local terminal or workstation to off-load work from the SUT. This includes, but is not limited to: screen presentations, message bundling, and local storage of TPC-C rows.*

Comment 2: *This disclosure also requires that all data manipulation functions performed by the local terminal to provide navigational aids for transaction(s) must also be described. Within this disclosure, the purpose of such additional function(s) must be explained.*

Application code involved in the manipulation of data was run on the client. Screen manipulation commands in the form of HTML were downloaded to the web browser, which handled input and output presentation graphics. A listing of this code is included in Appendix A. Microsoft Internet Information Service assisted in the processing and presentation of this data.

Transaction Profiles

The percentage of home and remote order-lines in the New-Order transactions must be disclosed. (8.1.3.5)

The percentage of New-Order transactions that were rolled back as a result of an unused item number must be disclosed. (8.1.3.6)

The number of items per orders entered by New-Order transactions must be disclosed. (8.1.3.7)

The percentage of home and remote Payment transactions must be disclosed. (8.1.3.8)

The percentage of Payment and Order-Status transactions that used non-primary key (C_LAST) access to the database must be disclosed. (8.1.3.9)

The percentage of Delivery transactions that were skipped as a result of an insufficient number of rows in the NEW-ORDER table must be disclosed. (8.1.3.10)

Table 1: Transaction Statistics

Transaction	Function	Value
New Order	Home Warehouse Items	99.00%
	Remote Warehouse Items	1.00%
	Rolled Back Transactions	0.99%
	Average Lines Per Order	10.00
Payment	Home Warehouse	85.00%
	Remote Warehouse	14.99%
	Non-Primary Key Access	60.01%
Order Status	Non-Primary Key Access	60.09%
Delivery	Skipped Transactions	0

Transaction Mix

The mix (i.e., percentages) of transaction types seen by the SUT must be disclosed. (8.1.3.11)

Table 2: Transaction mix

Transaction	Percentage
New Order	44.85%
Payment	43.04%
Order Status	4.03%
Delivery	4.04%
Stock Level	4.04%

Deferred Delivery Mechanism

The queuing mechanism used to defer the execution of the Delivery transaction must be disclosed. (8.1.3.12)

The application creates a semaphore-base thread pool consisting of a user-specified number of threads, which open DBLIB connections on the database. When a Delivery transaction is posted one of these threads makes the database call while the transaction's original thread returns control to the user. Upon completion the Delivery thread writes an entry in the Delivery log and returns to the thread pool.

The source code is listed in Appendix A.

Clause 3 -- Transaction and System Properties Related Items

ACID Tests

The results of the ACID tests must be disclosed along with a description of how the ACID requirements were met. This includes disclosing which case was followed for the execution of Isolation Test 7. (8.1.4.1)

All ACID property tests were successful. The executions are described below.

Atomicity

The system under test must guarantee that the database transactions are atomic; the system will either perform all individual operations on the data or will assure that no partially completed operations leave any effects on the data.

Completed Transactions

A row was selected in a script from the warehouse, district and customer tables, and the balances noted. A payment transaction was started with the same warehouse, district and customer identifiers and a known amount. The payment transaction was committed and the rows were verified to contain correctly updated balances.

Aborted Transactions

A row was selected in a script from the warehouse, district and customer tables, and the balances noted. A payment transaction was started with the same warehouse, district and customer identifiers and a known amount. The payment transaction was rolled back and the rows were verified to contain the original balances.

Consistency

Consistency is the property of the application that requires any execution of a database transaction to take the database from one consistent state to another, assuming that the database is initially in a consistent state.

Consistency conditions one through four were tested using a shell script to issue queries to the database. The results of the queries verified that the database was consistent for all four tests. A run was executed under full load lasting over ten (10) minutes and included a checkpoint. The shell script was executed again. The result of the same queries verified that the database remained consistent after the run.

Isolation

Sufficient conditions must be enabled at either the system or application level to ensure the required isolation defined above (clause 3.4.1) is obtained.

Isolation tests one through seven were executed using shell scripts to issue queries to the database. Each script included timestamps to demonstrate the concurrency of operations. The results of the queries were captured to files. The captured files were verified by the auditor to demonstrate the required isolation had been met.

In addition, the phantom tests and the stock level tests were executed and verified.

For Isolation test seven, case A was followed.

Durability

The tested system must guarantee durability: the ability to preserve the effects of committed transactions and insure database consistency after recovery from any one of the failures listed in Clause 3.5.3.

Durable Media Failure

Durability from media failure was demonstrated on a 600 warehouse database. The standard driving mechanism was used to generate the transaction load of 6000 users for the Loss of Data.

Loss of Data

Loss of data was demonstrated on the 600 Warehouse database. The standard driving mechanism was used to generate the transaction load of 6000 users for the test. To demonstrate recovery from a permanent failure of durable media containing TPC-C tables, the following steps were executed:

1. The 600 Warehouse database was used for this test.
2. The database was backed up using SQL Server backup facilities.
3. A sum of D_NEXT_O_ID was taken.
4. 6000 users were logged in to the database and ran transactions.
5. One disk drive in the data array was removed causing SQL Server errors.
6. The RTE was allowed to continue running. Completed transactions enroute from the clients were recorded. Error messages began appearing on the RTE screen.
7. The RTE was stopped.
8. SQL Server was stopped and restarted and a dump of the transaction log was taken.
9. SQL Server was stopped, Windows .NET was shutdown and the machine powered off.
10. The failed disk was replaced.
11. The machine was powered up, Windows .NET and SQL Server were started.
12. The TPC-C database was dropped and restored from backup.
13. The transaction log was restored and transactions rolled forward.
14. A new count of D_NEXT_O_ID was taken.
15. This number was compared with the number of new orders reported by the RTE.

Instantaneous Interruption and Loss of Memory/Loss of Log

Instantaneous Interruption and Loss of Memory were demonstrated on the full database with 6000 warehouses in a single test. The standard driving mechanism was used to generate the transaction load of 58,000 users for the test. To demonstrate recovery an instantaneous system interruption caused by powering off the Server, the following steps were executed:

1. The full database was used.
2. A sum of D_NEXT_O_ID was taken.
3. 58,000 users were logged in to the database and ran transactions.
4. The system was run in steady state for 5 minutes
5. One disk drive in the transaction log array was removed with no effect on Windows 2000 or SQL Server.
6. The system ran for an additional 5 minutes.
6. The Server was powered off by normal means, causing instantaneous interruption.

7. The RTE was allowed to continue running. Completed transactions enroute from the clients were recorded. Error messages began appearing on the RTE screen.
8. The RTE was stopped.
9. The server was powered on again and rebooted.
10. SQL Server was restarted and automatically recovered.
11. A new count of D_NEXT_O_ID was taken.
12. This number was compared with the number of new orders reported by the RTE

Clause 4 -- Scaling and Database Population Related Items

Table Cardinality

The cardinality (e.g., the number of rows) of each table, as it existed at the start of the benchmark run (see Clause 4.2), must be disclosed. If the database was over-scaled and inactive rows of the WAREHOUSE table were deleted (see Clause 4.2.2), the cardinality of the WAREHOUSE table as initially configured and the number of rows deleted must be disclosed. (8.1.5.1)

The database was originally built with 6000 warehouses. The performance run used 5800 warehouses and this is verified by runcheck

Table 3: Table Cardinality

Table	Cardinality as Benchmarked
Warehouse	6,000
District	60,000
Customer	180,000,000
History	180,000,000
NewOrder	54,000,000
Orders	180,000,000
OrderLine	1,799,998,798
Item	100,000
Stock	600,000,000
Deleted Warehouses	0

Constant Values

The following values were used as constant value inputs to the NURand function for this benchmark.

Table 4: Constant Values

Function	Constant C Value
C_LAST (Build)	123
C_LAST (Run)	208

Data Distribution

The distribution of tables and logs across all media must be explicitly depicted for the tested and priced systems. (8.1.5.2)

The Database was built using a total of 293 disks: 280 18GB for data, 12 18GB for log, and 1 18GB for OS and application software. The data drives were configured as hardware RAID 0. Logs were configured as hardware RAID 10. Mylex ExtremeRAID 2000 RAID Controllers were configured with 1 logical drives each. Each logical drive spanned 56 disk drives for data and 12 for logs. Each Windows .NET data drive contained 3 partitions: partition 1 for customer/stock, partition 2 for miscellaneous, and partition 3 for backup. Partitions 1 and 2 were RAW file systems and partition 3 was formatted NTFS. The details are shown in Table 5.

Table 5: Data Distribution

.NET Disk Administration	Adaptec 7899 Configuration				
Disk 0 17347MB	On-Board Controller # 1				
Partition	On-Board		Channels		
1	Internal	SCSI ID	0		
C: OS NTFS 17347 MB		0	A0-1		
		1			
		2			
		3			

.NET Disk Administration	MYLEX EXR2000P Configuration					
Disk 1 208261MB	Controller # 1					
Partition	Slot# 2		Channels			
1		SCSI ID	A	B	C	D
S: LOG Unknown 208261MB		0	A1-1	A1-2		
		1	A2-1	A2-2		
		2	A3-1	A3-2		
		3	A4-1	A4-2		
		4	A5-1	A5-2		
		5	A6-1	A6-2		
		8				
		9				
		10				
		11				
		12				
		13				

.NET Disk Administration			MYLEX EX2000P Configuration				
Disk 2 960962MB			Controller # 2				
Partition			Slot# 4	Channels			
1	2	3	SCSI ID	A	B	C	D
E: CS1 Unknown 154654MB	F: MS1 Unknown 85637MB	V: Backup1 NTFS 200000MB	0	A1-1	A2-1	A3-1	A4-1
			1	A1-2	A2-2	A3-2	A4-2
			2	A1-3	A2-3	A3-3	A4-3
			3	A1-4	A2-4	A3-4	A4-4
			4	A1-5	A2-5	A3-5	A4-5
			5	A1-6	A2-6	A3-6	A4-6
			8	A1-7	A2-7	A3-7	A4-7
			9	A1-8	A2-8	A3-8	A4-8
			10	A1-9	A2-9	A3-9	A4-9
			11	A1-10	A2-10	A3-10	A4-10
			12	A1-11	A2-11	A3-11	A4-11
			13	A1-12	A2-12	A3-12	A4-12
			14	A1-13	A2-13	A3-13	A4-13
			15	A1-14	A2-14	A3-14	A4-14

.NET Disk Administration			MYLEX EX2000P Configuration				
Disk 3 960962MB			Controller # 3				
Partition			Slot# 6	Channels			
1	2	3	SCSI ID	A	B	C	D
G: CS2 Unknown 154654MB	H: MS2 Unknown 85637MB	W: Backup2 NTFS 200000MB	0	A1-1	A2-1	A3-1	A4-1
			1	A1-2	A2-2	A3-2	A4-2
			2	A1-3	A2-3	A3-3	A4-3
			3	A1-4	A2-4	A3-4	A4-4
			4	A1-5	A2-5	A3-5	A4-5
			5	A1-6	A2-6	A3-6	A4-6
			8	A1-7	A2-7	A3-7	A4-7
			9	A1-8	A2-8	A3-8	A4-8
			10	A1-9	A2-9	A3-9	A4-9
			11	A1-10	A2-10	A3-10	A4-10
			12	A1-11	A2-11	A3-11	A4-11
			13	A1-12	A2-12	A3-12	A4-12
			14	A1-13	A2-13	A3-13	A4-13
			15	A1-14	A2-14	A3-14	A4-14

.NET Disk Administration			MYLEX EX2000P Configuration					
Disk 4 960962MB			Controller # 4					
Partition			Slot# 8		Channels			
1	2	3		SCSI ID	A	B	C	D
I: CS3 Unknown 154654MB	J: MS3 Unknown 85637MB	X: Backup3 NTFS 200000MB		0	A1-1	A2-1	A3-1	A4-1
				1	A1-2	A2-2	A3-2	A4-2
				2	A1-3	A2-3	A3-3	A4-3
				3	A1-4	A2-4	A3-4	A4-4
				4	A1-5	A2-5	A3-5	A4-5
				5	A1-6	A2-6	A3-6	A4-6
				8	A1-7	A2-7	A3-7	A4-7
				9	A1-8	A2-8	A3-8	A4-8
				10	A1-9	A2-9	A3-9	A4-9
				11	A1-10	A2-10	A3-10	A4-10
				12	A1-11	A2-11	A3-11	A4-11
				13	A1-12	A2-12	A3-12	A4-12
				14	A1-13	A2-13	A3-13	A4-13
				15	A1-14	A2-14	A3-14	A4-14

.NET Disk Administration			MYLEX EX2000P Configuration					
Disk 5 960962MB			Controller # 5					
Partition			Slot# 10		Channels			
1	2	3		SCSI ID	A	B	C	D
K: CS4 Unknown 154654MB	L: MS4 Unknown 85637MB	Y: Backup4 NTFS 200000MB		0	A1-1	A2-1	A3-1	A4-1
				1	A1-2	A2-2	A3-2	A4-2
				2	A1-3	A2-3	A3-3	A4-3
				3	A1-4	A2-4	A3-4	A4-4
				4	A1-5	A2-5	A3-5	A4-5
				5	A1-6	A2-6	A3-6	A4-6
				8	A1-7	A2-7	A3-7	A4-7
				9	A1-8	A2-8	A3-8	A4-8
				10	A1-9	A2-9	A3-9	A4-9
				11	A1-10	A2-10	A3-10	A4-10
				12	A1-11	A2-11	A3-11	A4-11
				13	A1-12	A2-12	A3-12	A4-12
				14	A1-13	A2-13	A3-13	A4-13
				15	A1-14	A2-14	A3-14	A4-14

.NET Disk Administration			MYLEX EX2000P Configuration					
Disk 6 960962MB			Controller # 6					
Partition			Slot# 11		Channels			
1	2	3		SCSI ID	A	B	C	D
M: CS5 Unknown 154654MB	N: MS5 Unknown 85637MB	Z: Backup5 NTFS 200000MB		0	A1-1	A2-1	A3-1	A4-1
				1	A1-2	A2-2	A3-2	A4-2
				2	A1-3	A2-3	A3-3	A4-3
				3	A1-4	A2-4	A3-4	A4-4
				4	A1-5	A2-5	A3-5	A4-5
				5	A1-6	A2-6	A3-6	A4-6
				8	A1-7	A2-7	A3-7	A4-7
				9	A1-8	A2-8	A3-8	A4-8
				10	A1-9	A2-9	A3-9	A4-9
				11	A1-10	A2-10	A3-10	A4-10
				12	A1-11	A2-11	A3-11	A4-11
				13	A1-12	A2-12	A3-12	A4-12
				14	A1-13	A2-13	A3-13	A4-13
				15	A1-14	A2-14	A3-14	A4-14

Comment: Detailed diagrams for layout of database files on disks can widely vary, and it is difficult to provide exact guideline suitable for all implementations. The intent is to provide sufficient detail to allow independent reconstruction of the test database. The two figures below are examples of database layout descriptions and are not intended to depict or imply any optimal layout for the TPC-C database.

8.1.5.3 A statement must be provided that describes:

1. The data model implemented by the DBMS used (e.g., relational, network, hierarchical)
2. The database interface (e.g., embedded, call level) and access language (e.g., SQL, DL/1, COBOL read/write) used to implement the TPC-C transactions. If more than one interface/access language is used to implement TPC-C, each interface/access language must be described and a list of which interface/access language is used with which transaction type must be disclosed.

Microsoft SQL Server 2000 Enterprise Edition is a relational DBMS.

The interface used was Microsoft SQL Server stored procedures accessed with Remote Procedure Calls embedded in C code using the Microsoft DBLIB interface.

Partition Mapping

The mapping of database partitions/replications must be explicitly described.

Comment: *The intent is to provide sufficient detail about partitioning and replication to allow independent reconstruction of the test database. (8.1.5.4)*

An description of a database partitioning scheme is presented below as an example. The nomenclature of this example was outlined using the CUSTOMER table (in Clause 8.1.2.1), and has been extended to use the ORDER and ORDER_LINE tables as well.

The database was not replicated.

60 day Space Calculation

Details of the 60 day space computations along with proof that the database is configured to sustain 8 hours of growth for the dynamic tables (Order, Order-Line, and History) must be disclosed (see Clause 4.2.3). (8.1.5.5)

To calculate the space required to sustain the database log for 8 hours of growth at steady state, the following steps were followed:

1. The current log space usage was determined by running *dbcc sqlperf(logspace)*
2. Transactions were run against the database with a full load of users.
3. The final log space usage was determined by running *dbcc sqlperf(logspace)*
4. The space used was calculated as the difference between the first and second query.
5. The number of NEW-ORDERS was verified from an RTE report covering the entire run.
6. The space used was divided by the number of NEW-ORDERS giving a space used per NEW-ORDER transaction.
7. The space used per transaction was multiplied by the measured tpmC rate times 480 minutes.

The results of the above steps yielded a requirement of 343.73 GB (including mirror) to sustain the log for 8 hours. Space available on the transaction log volume was 416.54GB (including mirror), indicating that enough storage was configured to sustain 8 hours of growth.

The same methodology was used to compute growth requirements for dynamic tables Order, Order-Line and History.

The details of the 60-day space requirement is shown in Appendix D.

Clause 5 -- Performance Metrics and Response Time Related Items

Measured TpmC

Measured tpmC must be reported. (8.1.6.1)

Measured TpmC 71,313.19
 Price per TpmC \$5.13

Response Times

Ninetieth percentile, maximum and average response times must be reported for all transaction types as well as for the Menu response time. (8.1.6.2)

Table 6: Transaction Response Times

Transaction	Average	90%	Maximum
New Order	0.73	1.12	6.71
Payment	0.60	0.98	4.91
Order Status	0.62	0.99	5.95
Interactive Delivery	0.19	0.41	1.42
Deferred Delivery	0.29	0.39	1.34
Stock Level	1.28	1.75	4.57
Menu	0.19	0.41	1.41

Think Times & Key Times

The minimum, the average, and the maximum keying and think times must be reported for each transaction type. (8.1.6.3)

Table 7: Transaction Key Times

Transaction	Minimum	Average	Maximum
New Order	18.01	18.02	18.17
Payment	3.01	3.02	3.17
Order Status	2.01	2.02	2.16
Delivery	2.01	2.02	2.16
Stock Level	2.01	2.02	2.18

Table 8: Transaction Think Times

Transaction	Minimum	Average	Maximum
New Order	0.00	12.04	120.45
Payment	0.00	12.04	120.45
Order Status	0.00	10.04	100.42
Delivery	0.00	5.05	50.44
Stock Level	0.00	5.05	50.42

Response Time Distribution Curves

Response Time frequency distribution curves (see Clause 5.6.1) must be reported for each transaction type. (8.1.6.4)

Figure 2: New Order Response Time Distribution

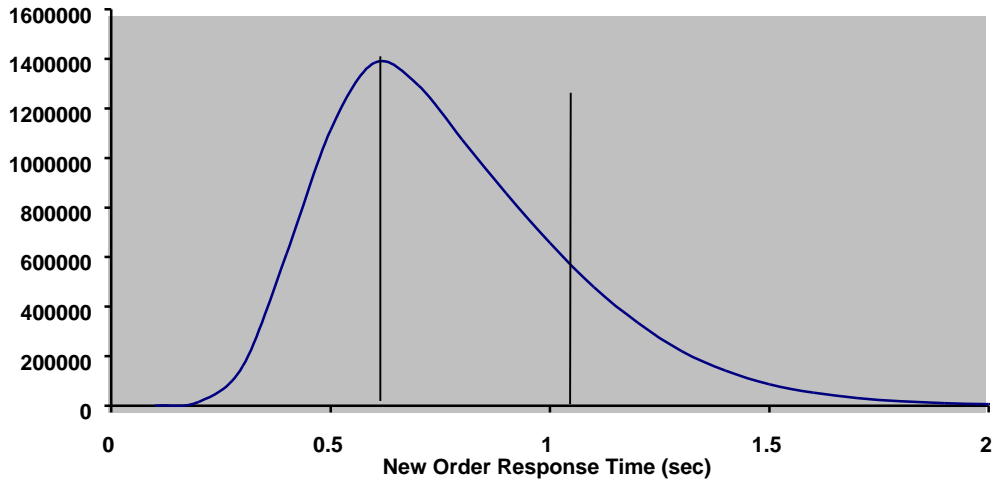

Figure 3: Payment Response Time Distribution

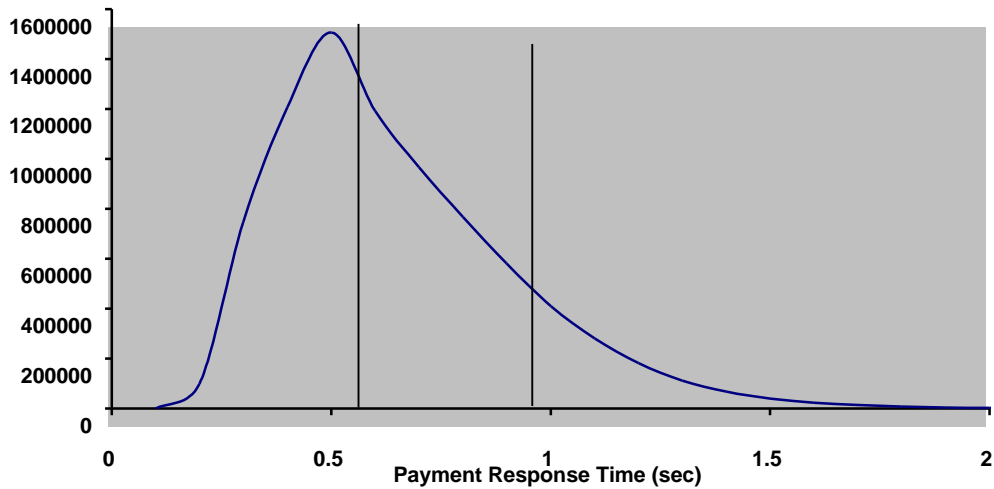

Figure 4: Order Status Response Time Distribution

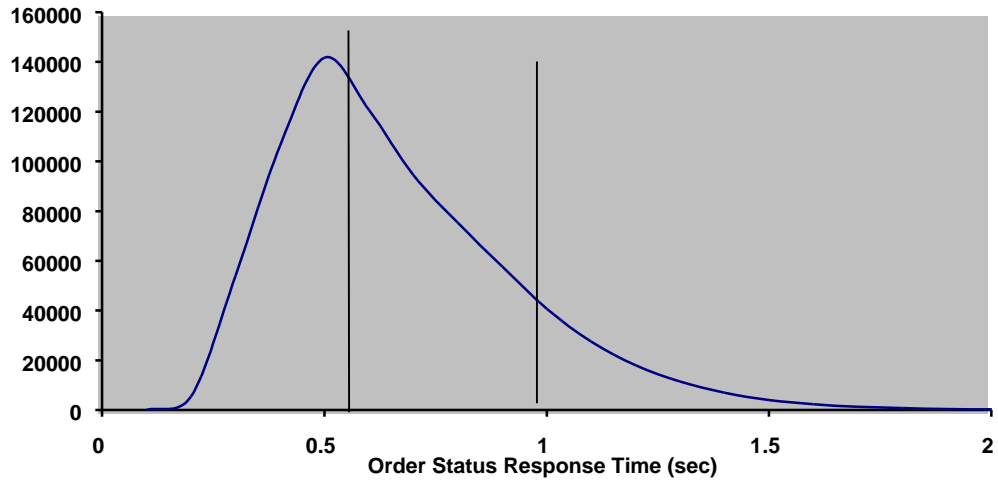

Figure 5: Delivery Response Time Distribution

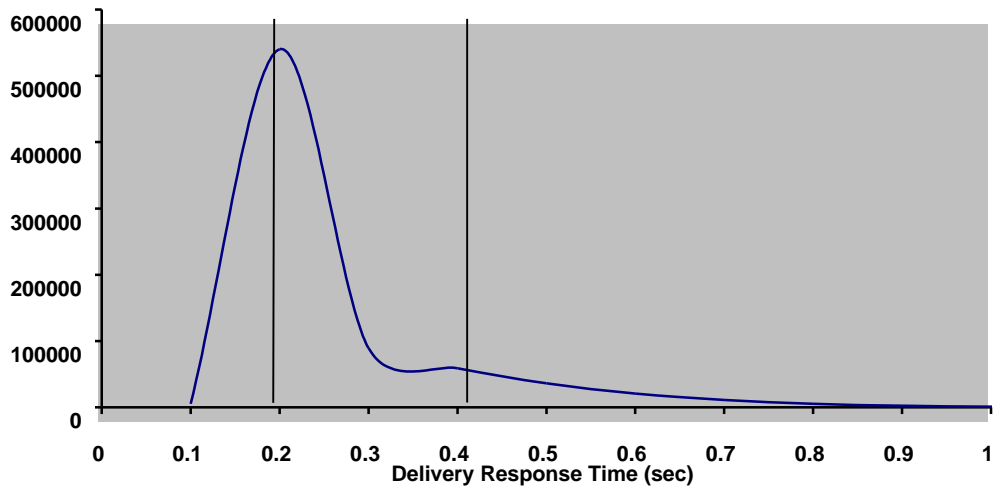
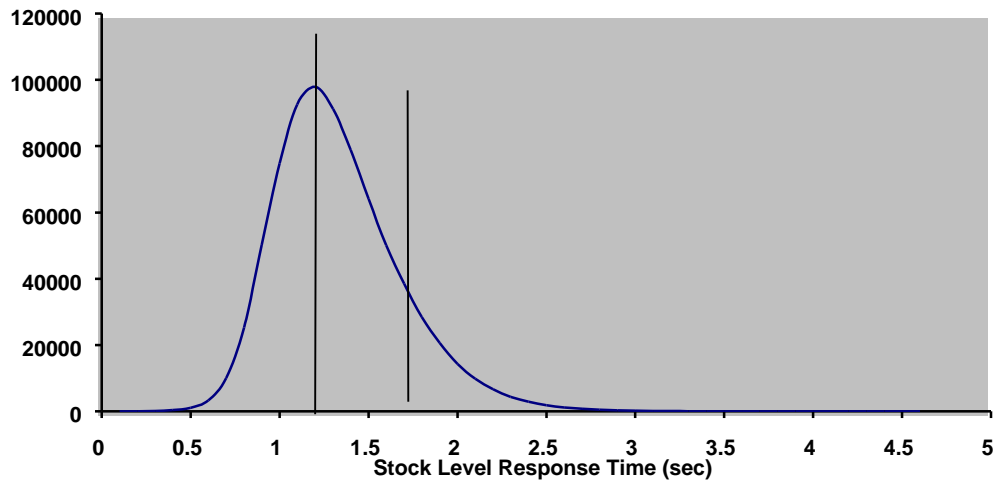

Figure 6: Stock Level Response Time Distribution



New-Order Response Time vs. Throughput Graph

The performance curve for response times versus throughput (see Clause 5.6.2) must be reported for the New-Order transaction. (8.1.6.5)

Figure 8: New Order Response Time vs. Throughput

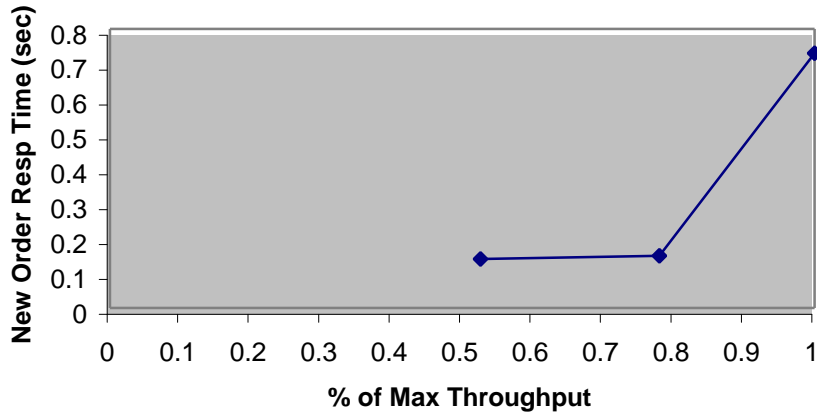

New-Order Think Time Distribution Graph

Think Time frequency distribution curves (see Clause 5.6.3) must be reported for the New-Order transaction (8.1.6.6)

Figure 9: New Order Think Time Distribution

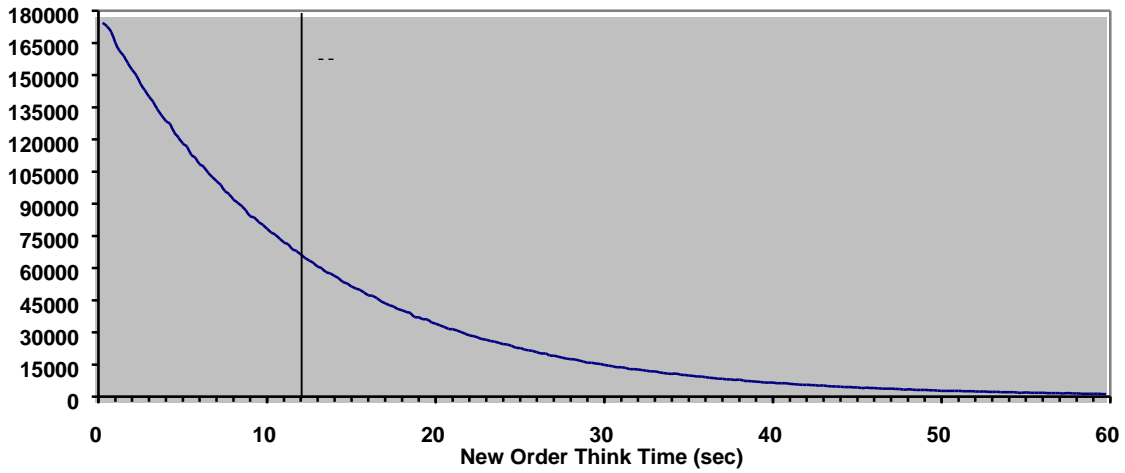

Steady-State Graph

A graph of throughput versus elapsed time (see Clause 5.6.5) must be reported for the New-Order transaction. (8.1.6.8)

Figure 10: New Order Throughput vs. Time

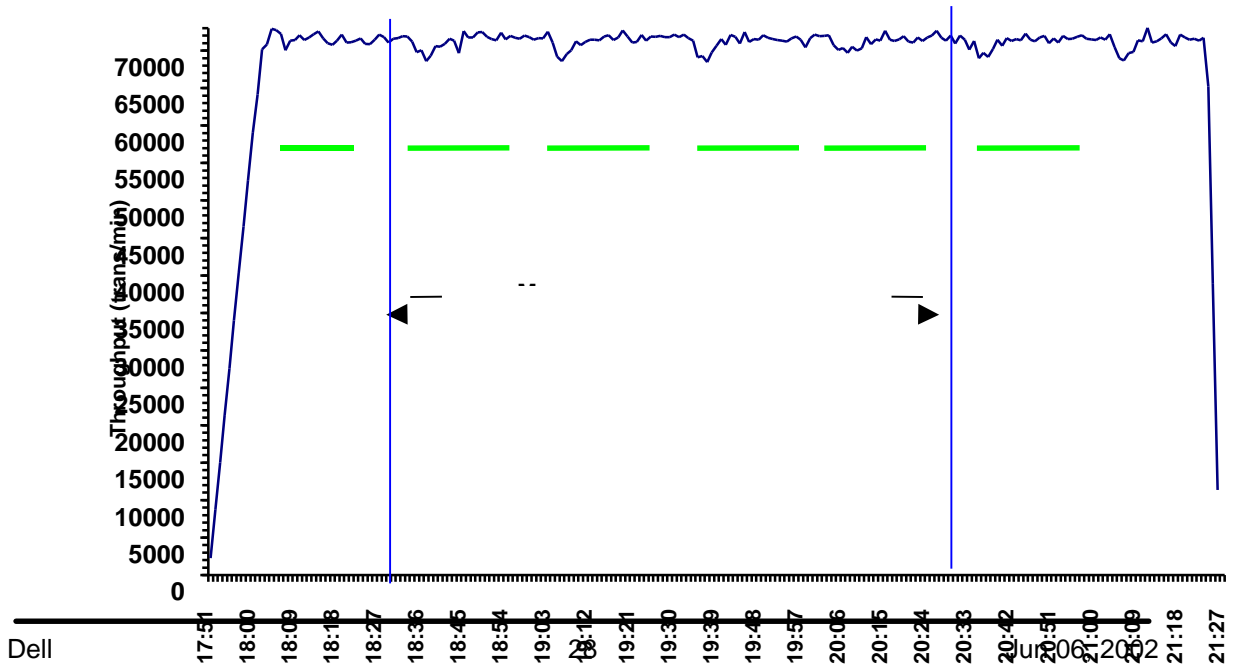

Steady-State Methodology

The method used to determine that the SUT had reached a steady state prior to commencing the measurement interval (see Clause 5.5) must be described. (8.1.6.9)

Steady state was determined using real time monitor utilities from both the operating system and the RTE. Steady state was further confirmed by the throughput data collected during the run and graphed in Figure 10.

Work Performed During Steady State

A description of how the work normally performed during a sustained test (for example checkpointing, writing redo/undo log records, etc.), actually occurred during the measurement interval must be reported. (8.1.6.10)

The RTE generated the required input data to choose a transaction from the menu. This data was timestamped. The menu response for the requested transaction was verified and timestamped in the RTE log files.

The RTE generated the required input data for the chosen transaction. It waited to complete the minimum required key time before transmitting the HTTP request to the client. The transmission was timestamped. The return of the screen with the required response data was timestamped. The difference between these two timestamps was the response time for that transaction and was logged in the RTE log.

The RTE then waited the required think time interval before repeating the process starting at selecting another transaction from the menu.

The RTE transmissions were sent to the web-based application program running on the client machines through Ethernet LANs. These web clients managed the emulated web browser interface as well as all requests to the database on the server. The applications communicated with the database server over another Ethernet LAN using the COM+ transaction monitor and Microsoft SQL Server DBLIB library and RPC calls.

To perform checkpoints at specific intervals, we set SQL Server *recovery interval* to 80 and wrote a script to schedule multiple checkpoints at specific intervals. By setting the TRACE FLAG #3502, SQL Server logged the checkpoint beginning and ending time in the ERRORLOG file. The script included a wait time between each checkpoint equal to the measurement interval, which was 30 minutes. The checkpoint script was started manually after the RTE had all users logged in and sending transactions.

At each checkpoint, Microsoft SQL Server wrote to disk all memory pages that had been updated but not yet physically written to disk. Upon completion of the checkpoint, Microsoft SQL Server wrote a special record to the recovery log to indicate that all disk operations had been satisfied to this point.

Measurement Interval

A statement of the duration of the measurement interval for the reported Maximum Qualified Throughput (tpmC) must be included. (8.1.6.12)

The measurement interval was 7200 minutes.

Measurement Period Duration and Checkpoint Duration

The start time and duration in seconds of at least the four (4) longest checkpoints during the measurement interval must be disclosed (see clause 5.5.2.2(2)) (8.1.6.11)

A statement of the duration of the measurement interval for the reported Maximum Qualified Throughput (tpmC) must be included. (8.1.6.12)

	Start	End	Duration
Measurement Interval	18:30:50	18:25:19	7,200
1 st Checkpoint	18:35:14	18:55:15	1201
2 nd Checkpoint	19:05:09	19:25:09	1200
3 rd Checkpoint	19:35:04	19:55:04	1200
4 th Checkpoint	20:04:49	21:24:49	1200

Transaction Mix

8.1.6.13 The method of regulation of the transaction mix (e.g., card decks or weighted random distribution) must be described. If weighted distribution is used and the RTE adjusts the weights associated with each transaction type, the maximum adjustments to the weight from the initial value must be disclosed. (8.1.6.13)

The RTE was given a weighted random distribution that was not adjusted during the run.

The percentage of the total mix for each transaction type must be disclosed. (8.1.6.14)

Table 9: Transaction Mix

Transaction	Percentage
New Order	44.85%
Payment	43.04%
Order Status	4.03%
Delivery	4.04%
Stock Level	4.04%

Other Metrics

The percentage of New-Order transactions rolled back as a result of invalid item number must be disclosed. (8.1.6.15)

The average number of order-lines entered per New-Order transaction must be disclosed. (8.1.6.16)

The percentage of remote order-lines entered per New-Order transaction must be disclosed. (8.1.6.17)

The percentage of remote Payment transactions must be disclosed. (8.1.6.18)

The percentage of customer selections by customer last name in the Payment and Order-Status

transactions must be disclosed. (8.1.6.19)

The percentage of Delivery transactions skipped due to there being fewer than necessary orders in the New-Order table must be disclosed. (8.1.6.20)

Table 10: Transaction Statistics

Transaction	Function	Value
New Order	Home Warehouse Items	99.00%
	Remote Warehouse Items	1.00%
	Rolled Back Transactions	0.99%
	Average Lines Per Order	10.00
Payment	Home Warehouse	84.00%
	Remote Warehouse	14.99%
	Non-Primary Key Access	60.01%
Order Status	Non-Primary Key Access	60.09%
Delivery	Skipped Transactions	0

Clause 6 -- SUT, Driver, and Communication Definition Related Items

RTE Parameters

The RTE input parameters, code fragments, functions, etc. used to generate each transaction input field must be disclosed. (8.1.7.1)

Comment: *The intent is to demonstrate the RTE was configured to generate transaction input data as specified in Clause 2.*

The RTE input parameters are listed in Appendix C - Tunable Parameters.

Emulated Components

It must be demonstrated that the functionality and performance of the components being emulated in the Driver System are equivalent to that of the priced system. The results of the test described in Clause 6.6.3.4 must be disclosed. (8.1.7.2)

No components were emulated.

Benchmarked and Targeted System Configuration Diagrams

A complete functional diagram of both the benchmark configuration and the configuration of the proposed (target) system must be disclosed. A detailed list of all software and hardware functionality being performed on the Driver System, and its interface to the SUT must be disclosed (see Clause 6.6.3.6). (8.1.7.3)

The driver system performed transaction data generation and communication to the client through the standard web browser (HTTP) protocol. It also captured and timestamped the SUT output data for post-processing of the reported metrics. No other functionality was included on the driver system.

Figures 1 & 2 of this report contain detailed diagrams of both the benchmark configuration and the priced configuration.

Network Configuration

The network configurations of both the tested services and the proposed (target) services which are being represented and a thorough explanation of exactly which parts of the proposed configuration are being replaced with the Driver System must be disclosed (see Clause 6.6.4). (8.1.7.4)

The network configurations of the benchmarked and priced configurations were identical.

Network Bandwidth

The bandwidth of the network(s) used in the tested/priced configuration must be disclosed. (8.1.7.5)

The bandwidth of the tested and priced networks were as follows:

- 10 BaseT (10 Mbit/sec) network segments between the RTE/Emulated Users and the switch.
- 100 BaseT (100 Mbit/sec) between the Clients and Server.

Operator Intervention

If the configuration requires operator intervention (see Clause 6.6.6), the mechanism and the frequency of this intervention must be disclosed. (8.1.7.6)

This configuration does not require any operator intervention to sustain eight hours of the reported throughput.

Clause 7 -- Pricing Related Items

Hardware and Software List

A detailed list of hardware and software used in the priced system must be reported. Each separately orderable item must have vendor part number, description, and release/revision level, and either general availability status or committed delivery date. If package-pricing is used, vendor part number of the package and a description uniquely identifying each of the components of the package must be disclosed.

Pricing source(s) and effective date(s) of price(s) must also be reported. (8.1.8.1)

The total 5-year price of the entire configuration must be reported, including: hardware, software, and maintenance charges. Separate component pricing is recommended. The basis of all discounts used must be disclosed. (8.1.8.2)

The details of the hardware and software are reported in the front of this report as part of the executive summary. All third party quotations are included at the end of this report as Appendix E.

Availability Date

The committed delivery date for general availability (availability date) of products used in the price calculations must be reported. When the priced system includes products with different availability dates, the reported availability date for the priced system must be the date at which all components are committed to be available. (8.1.8.3)

Hardware Availability Date: Mar 31, 2003

Software Availability Date: Mar 31, 2003

Measured TpmC

A statement of the measured tpmC, as well as the respective calculations for 5-year pricing, price/performance (price/tpmC), and the availability date must be included. (8.1.8.4)

Maximum Qualified Throughput: 71,313.19 tpmC

Price Performance Metric: \$5.13

Country Specific Pricing

Additional Clause 7 related items may be included in the Full Disclosure Report for each country specific priced configuration. Country specific pricing is subject to Clause 7.1.7. (8.1.8.5)

This system is priced for the United States of America.

Usage Pricing

For any usage pricing, the sponsor must disclose (8.1.8.6):

- *Usage level at which the component was priced.*
- *A statement of the company policy allowing such pricing.*

Comment: *Usage pricing may include, but is not limited to, the operating system and database management software.*

The component pricing based on usage is shown below:

- 8 Microsoft Windows 2000 Server Licenses
- 1 Microsoft Windows .NET Enterprise Server License
- 1 Microsoft SQL Server 2000 Enterprise Edition License.
- 1 Microsoft Visual C++ 32 bit Edition
- 3 Year Support for Hardware Components.

System Pricing

System pricing should include subtotals for the following components: Server Hardware, Server Software, Client Hardware, Client Software, and Network Components used for terminal connection (see Clause 7.2.2.3). Clause 6.1 describes the Server and Client components. An example of the standard pricing sheet is shown in Appendix B. (8.1.8.7)

System pricing must include line item indication where non-sponsoring companies' brands are used. System pricing must also include line item indication of third party pricing. See example in Appendix B. (8.1.8.8)

The details of the hardware and software are reported in the front of this report as part of the executive summary. All third party quotations are included at the end of this report as Appendix E.

Clause 9 -- Audit Related Items

Auditor

The auditor's name, address, phone number, and a copy of the auditor's attestation letter indicating compliance must be included in the Full Disclosure Report. (8.1.9.1)

A review of the pricing model is required to ensure that all components required are priced (see Clause 9.2.8). The auditor is not required to review the final Full Disclosure Report or the final pricing prior to issuing the attestations letter. (8.1.9.2)

This TPC-C benchmark has been audited by Lorna Livingtree of Performance Metrics.

Availability of the Full Disclosure Report

The Full Disclosure Report must be readily available to the public at a reasonable charge, similar to the charges for similar documents by the test sponsor. The report must be made available when results are made public. In order to use the phrase "TPC Benchmark™ C", the Full Disclosure Report must have been submitted to the TPC Administrator as well as written permission obtained to distribute same.

Requests for this TPC Benchmark C Full Disclosure Report should be sent to:

Transaction Processing Performance Council
c/o Administrator, TPC
Presidio of San Francisco
Bldg 572B Ruger St.
San Francisco, CA 94129-0920
Phone: (415) 561-6272, fax 415-561 6120
www.tpc.org

or:

Dell
One Dell Way
Round Rock, TX 78682
Attention: Mike Molloy

Auditor's Letter of Attestation

December 21, 2002

Mike Molloy
Senior Manager, Server Performance Analysis
Dell Computer Corporation
One Dell Way
Round Rock, TX 78682

I have verified by remote the TPC Benchmark™ C for the following configuration:

Platform: PowerEdge 6600
Database Manager: Microsoft SQL Server 2000 Enterprise Edition
Operating System: Microsoft Windows .NET Enterprise Server 2003
Transaction Monitor: Microsoft COM+

Servers: PowerEdge 6600				
CPU's	Memory	Disks (total)	90% Response	TpmC
4 Intel Xeon @ 2 Ghz	Main: 32 GB Cache: 1024 KB	280 @ 18GB 1 OS @ 18 GB 12 @ 36 GB	1.12	71,313.19
8 Clients: PowerEdge 1500SC				
1 Pentium III @ 1.13 Ghz	Main: 512 MB Cache: 512 KB	1 @ 18 GB	Na	Na

In my opinion, these performance results were produced in compliance with the TPC requirements for the benchmark. The following attributes of the benchmark were given special attention:

- The transactions were correctly implemented.
- The database files were properly sized and populated.
- The database was properly scaled with 6000 warehouses of which 5800 were active during the measured interval.
- The ACID properties were successfully demonstrated.
- Input data was generated according to the specified percentages.
- Eight hours of mirrored log space was present on the tested system.
- Eight hours of growth space for the dynamic tables was present on the tested system.
- The data for the 60 day space calculation was verified.
- The controller cache was disabled on the log controller.
- The steady state portion of the test was 120 minutes.
- One checkpoint was taken before the measured interval.

- Four checkpoints were taken during the measured interval.

Auditor Notes:

None.

Sincerely,

A handwritten signature in cursive script that reads "Lorna Livingtree".

Lorna Livingtree
Auditor

Appendix A - Application Source Code

Appendix A - Application Source Code

tpcc.dll ISAPI DLL Source Code

isapi_dll/src/tpcc.def

```
LIBRARY TPCC.DLL

EXPORTS

    GetExtensionVersion @1
    HttpExtensionProc @2
    TerminateExtension @3
```

Isapi_dll/src/tpcc.h

```
/*      FILE:          TPCC.H
 *
 *      Microsoft TPC-C Kit Ver. 4.20.000
 *      Copyright Microsoft, 1999
 *
 *      All Rights Reserved
 *
 *      Version 4.10.000 audited by Richard Gimarc,
 *      Performance Metrics, 3/17/99
 *
 *      PURPOSE:  Header file for ISAPI TPCC.DLL, defines structures and functions used
 *      in the isapi tpcc.dll.
 */

//VERSION RESOURCE DEFINES
#define _APS_NEXT_RESOURCE_VALUE          101
#define _APS_NEXT_COMMAND_VALUE          40001
#define _APS_NEXT_CONTROL_VALUE          1000
#define _APS_NEXT_SYMED_VALUE          101

#define TP_MAX_RETRIES
    50

//note that the welcome form must be processed first as terminal ids assigned here, once
the
//terminal id is assigned then the forms can be processed in any order.
#define WELCOME_FORM                      1
    //beginning form no term id assigned, form id
```

```
#define MAIN_MENU_FORM                    2
    //term id assigned main menu form id
#define NEW_ORDER_FORM                    3
    //new order form id
#define PAYMENT_FORM                      4
    //payment form id
#define DELIVERY_FORM                     5
    //delivery form id
#define ORDER_STATUS_FORM                 6
    //order status id
#define STOCK_LEVEL_FORM                  7
    //stock level form id

//This macro is used to prevent the compiler error unused formal parameter
#define UNUSEDPARAM(x) (x = x)

//This structure defines the data necessary to keep distinct for each terminal or client
connection.
typedef struct _CLIENTDATA
{
    int                iNextFree;
    //index of next free element or -1 if this entry in use.
    int                w_id;
    //warehouse id assigned at welcome form
    int                d_id;
    //district id assigned at welcome form

    int                iSyncId;
    //synchronization id
    int                iTickCount;
    //time of last access;

    CTPCC_BASE        *pTxn;
} CLIENTDATA, *PCLIENTDATA;

//This structure is used to define the operational interface for terminal id support
typedef struct _TERM
{
    int                iNumEntries;
    //total allocated terminal array entries
    int                iFreeList;
    //next available terminal array element or -1 if none
    int                iMasterSyncId;
    //synchronization id
    CLIENTDATA        *pClientData;
    //pointer to allocated client data
} TERM;

typedef TERM *PTERM;
    //pointer to terminal structure type

enum WEBERROR
{
    NO_ERR,
    ERR_COMMAND_UNDEFINED,
    ERR_D_ID_INVALID,
    ERR_DELIVERY_CARRIER_ID_RANGE,
    ERR_DELIVERY_CARRIER_INVALID,
    ERR_DELIVERY_MISSING_OCD_KEY,
```

Appendix A - Application Source Code

```
ERR_DELIVERY_THREAD_FAILED,
ERR_GETPROCADDR_FAILED,
ERR_HTML_ILL_FORMED,
ERR_INVALID_SYNC_CONNECTION,
ERR_INVALID_TERMID,
ERR_LOADDLL_FAILED,
ERR_MAX_CONNECTIONS_EXCEEDED,
ERR_MEM_ALLOC_FAILED,
ERR_MISSING_REGISTRY_ENTRIES,
ERR_NEWORDER_CUSTOMER_INVALID,
ERR_NEWORDER_CUSTOMER_KEY,
ERR_NEWORDER_DISTRICT_INVALID,
ERR_NEWORDER_FORM_MISSING_DID,
ERR_NEWORDER_ITEMID_INVALID,
ERR_NEWORDER_ITEMID_RANGE,
ERR_NEWORDER_ITEMID_WITHOUT_SUPPW,
ERR_NEWORDER_MISSING_IID_KEY,
ERR_NEWORDER_MISSING_QTY_KEY,
ERR_NEWORDER_MISSING_SUPPW_KEY,
ERR_NEWORDER_NOITEMS_ENTERED,
ERR_NEWORDER_QTY_INVALID,
ERR_NEWORDER_QTY_RANGE,
ERR_NEWORDER_QTY_WITHOUT_SUPPW,
ERR_NEWORDER_SUPPW_INVALID,
ERR_NO_SERVER_SPECIFIED,
ERR_ORDERSTATUS_CID_AND_CLT,
ERR_ORDERSTATUS_CID_INVALID,
ERR_ORDERSTATUS_CLT_RANGE,
ERR_ORDERSTATUS_DID_INVALID,
ERR_ORDERSTATUS_MISSING_CID_CLT,
ERR_ORDERSTATUS_MISSING_CID_KEY,
ERR_ORDERSTATUS_MISSING_CLT_KEY,
ERR_ORDERSTATUS_MISSING_DID_KEY,
ERR_PAYMENT_CDI_INVALID,
ERR_PAYMENT_CID_AND_CLT,
ERR_PAYMENT_CUSTOMER_INVALID,
ERR_PAYMENT_CWI_INVALID,
ERR_PAYMENT_DISTRICT_INVALID,
ERR_PAYMENT_HAM_INVALID,
ERR_PAYMENT_HAM_RANGE,
ERR_PAYMENT_LAST_NAME_TOO_LONG,
ERR_PAYMENT_MISSING_CDI_KEY,
ERR_PAYMENT_MISSING_CID_CLT,
ERR_PAYMENT_MISSING_CID_KEY,
ERR_PAYMENT_MISSING_CLT,
ERR_PAYMENT_MISSING_CLT_KEY,
ERR_PAYMENT_MISSING_CWI_KEY,
ERR_PAYMENT_MISSING_DID_KEY,
ERR_PAYMENT_MISSING_HAM_KEY,
ERR_STOCKLEVEL_MISSING_THRESHOLD_KEY,
ERR_STOCKLEVEL_THRESHOLD_INVALID,
ERR_STOCKLEVEL_THRESHOLD_RANGE,
ERR_VERSION_MISMATCH,
ERR_W_ID_INVALID
};

class CWEBCLNT_ERR : public CBaseErr
{
public:
    CWEBCLNT_ERR(WEBERROR Err)
    {
        m_Error = Err;
    }
};

m_szTextDetail = NULL;
m_SystemErr = 0;
m_szErrorText = NULL;
};

CWEBCLNT_ERR(WEBERROR Err, char *szTextDetail, DWORD dwSystemErr)
{
    m_Error = Err;
    m_szTextDetail = new char[strlen(szTextDetail)+1];
    strcpy( m_szTextDetail, szTextDetail );
    m_SystemErr = dwSystemErr;
    m_szErrorText = NULL;
};

~CWEBCLNT_ERR()
{
    if (m_szTextDetail != NULL)
        delete [] m_szTextDetail;
    if (m_szErrorText != NULL)
        delete [] m_szErrorText;
};

WEBERROR m_Error;
char *m_szTextDetail; //
char *m_szErrorText;
DWORD m_SystemErr;

int ErrorType() {return ERR_TYPE_WEBDLL;};
int ErrorNum() {return m_Error;};
char *ErrorText();
};

//These constants have already been defined in engstut.h, but since we do
//not want to include it in the delisrv executable
#define TXN_EVENT_START 2
#define TXN_EVENT_STOP 4
#define TXN_EVENT_WARNING 6 //used to record a warning into the log

//function prototypes

BOOL APIENTRY DllMain(HANDLE hModule, DWORD ul_reason_for_call, LPVOID lpReserved);
void WriteMessageToEventLog(LPTSTR lpszMsg);
void ProcessQueryString(EXTENSION_CONTROL_BLOCK *pECB, int *pCmd, int *pFormId, int *pTermId, int *pSyncId);
void WelcomeForm(EXTENSION_CONTROL_BLOCK *pECB, char *szBuffer);
void SubmitCmd(EXTENSION_CONTROL_BLOCK *pECB, char *szBuffer);
void BeginCmd(EXTENSION_CONTROL_BLOCK *pECB, int iFormId, int iTermId);
void ProcessCmd(EXTENSION_CONTROL_BLOCK *pECB, int iFormId, int iTermId);
void StatsCmd(EXTENSION_CONTROL_BLOCK *pECB, char *szBuffer);
void ErrorMessage(EXTENSION_CONTROL_BLOCK *pECB, int iError, int iErrorType, char *szMsg, int iTermId);
void GetKeyValue(char **pQueryString, char *pKey, char *pValue, int iMax, WEBERROR err);
int GetIntKeyValue(char **pQueryString, char *pKey, WEBERROR NoKeyErr, WEBERROR NotIntErr);
void TermInit(void);
void TermDeleteAll(void);
int TermAdd(void);
void TermDelete(int id);
void ErrorForm(EXTENSION_CONTROL_BLOCK *pECB, int iType, int iErrorNum, int iTermId, int iSyncId, char *szErrorText, char *szBuffer);
void MakeMainMenuForm(int iTermId, int iSyncId, char *szForm);
```

Appendix A - Application Source Code

```
void MakeStockLevelForm(int iTermId, STOCK_LEVEL_DATA *pStockLevelData, BOOL bInput, char *szForm);
void MakeNewOrderForm(int iTermId, NEW_ORDER_DATA *pNewOrderData, BOOL bInput, char *szForm);
void MakePaymentForm(int iTermId, PAYMENT_DATA *pPaymentData, BOOL bInput, char *szForm);
void MakeOrderStatusForm(int iTermId, ORDER_STATUS_DATA *pOrderStatusData, BOOL bInput, char *szForm);
void MakeDeliveryForm(int iTermId, DELIVERY_DATA *pDeliveryData, BOOL bInput, char *szForm);
void ProcessNewOrderForm(EXTENSION_CONTROL_BLOCK *pECB, int iTermId, char *szBuffer);
void ProcessPaymentForm(EXTENSION_CONTROL_BLOCK *pECB, int iTermId, char *szBuffer);
void ProcessOrderStatusForm(EXTENSION_CONTROL_BLOCK *pECB, int iTermId, char *szBuffer);
void ProcessDeliveryForm(EXTENSION_CONTROL_BLOCK *pECB, int iTermId, char *szBuffer);
void ProcessStockLevelForm(EXTENSION_CONTROL_BLOCK *pECB, int iTermId, char *szBuffer);
void GetNewOrderData(LPSTR lpszQueryString, NEW_ORDER_DATA *pNewOrderData);
void GetPaymentData(LPSTR lpszQueryString, PAYMENT_DATA *pPaymentData);
void GetOrderStatusData(LPSTR lpszQueryString, ORDER_STATUS_DATA *pOrderStatusData);
BOOL PostDeliveryInfo(short w_id, short o_carrier_id);
BOOL IsNumeric(char *ptr);
BOOL IsDecimal(char *ptr);
void DeliveryWorkerThread(void *ptr);
```

isapi_dll/src/tpcc.rc

```
//Microsoft Developer Studio generated resource script.
//
#include "resource.h"

#define APSTUDIO_READONLY_SYMBOLS
//
// Generated from the TEXTINCLUDE 2 resource.
//
#include "afxres.h"

//
// English (U.S.) resources
//

#if !defined(AFX_RESOURCE_DLL) || defined(AFX_TARG_ENU)
#ifdef _WIN32
LANGUAGE LANG_ENGLISH, SUBLANG_ENGLISH_US
#pragma code_page(1252)
#endif // _WIN32

#ifdef _MAC
//
// Version
//

VS_VERSION_INFO VERSIONINFO
FILEVERSION 0,4,0,0
PRODUCTVERSION 0,4,0,0
FILEFLAGSMASK 0x3fL
#ifdef _DEBUG
FILEFLAGS 0x1L
```

```
#else
FILEFLAGS 0x0L
#endif
FILEOS 0x40004L
FILETYPE 0x2L
FILESUBTYPE 0x0L
BEGIN
    BLOCK "StringFileInfo"
    BEGIN
        BLOCK "040904b0"
        BEGIN
            VALUE "Comments", "TPC-C HTML DLL Server (DBLIB)\0"
            VALUE "CompanyName", "Microsoft\0"
            VALUE "FileDescription", "TPC-C HTML DLL Server (DBLIB)\0"
            VALUE "FileVersion", "0, 4, 0, 0\0"
            VALUE "InternalName", "tpcc\0"
            VALUE "LegalCopyright", "Copyright © 1997\0"
            VALUE "OriginalFilename", "tpcc.dll\0"
            VALUE "ProductName", "Microsoft tpcc\0"
            VALUE "ProductVersion", "0, 4, 0, 0\0"
        END
    END
    BLOCK "VarFileInfo"
    BEGIN
        VALUE "Translation", 0x409, 1200
    END
END

#endif // !_MAC

#ifdef APSTUDIO_INVOKED
//
// TEXTINCLUDE
//

1 TEXTINCLUDE DISCARDABLE
BEGIN
    "resource.h\0"
END

2 TEXTINCLUDE DISCARDABLE
BEGIN
    "#include \"afxres.h\"\r\n"
    "\0"
END

3 TEXTINCLUDE DISCARDABLE
BEGIN
    "\r\n"
    "\0"
END

#endif // APSTUDIO_INVOKED

//
// Dialog
//

IDD_DIALOG1 DIALOG DISCARDABLE 0, 0, 186, 95
```

Appendix A - Application Source Code

```
STYLE_DS_MODALFRAME | WS_POPUP | WS_CAPTION | WS_SYSMENU
CAPTION "Dialog"
FONT 8, "MS Sans Serif"
BEGIN
    DEFPUSHBUTTON   "OK",IDOK,129,7,50,14
    PUSHBUTTON     "Cancel",IDCANCEL,129,24,50,14
END

////////////////////////////////////
//
// DESIGNINFO
//

#ifdef APSTUDIO_INVOKED
GUIDELINES DESIGNINFO DISCARDABLE
BEGIN
    IDD_DIALOG1, DIALOG
    BEGIN
        LEFTMARGIN, 7
        RIGHTMARGIN, 179
        TOPMARGIN, 7
        BOTTOMMARGIN, 88
    END
END
#endif // APSTUDIO_INVOKED

#endif // English (U.S.) resources
////////////////////////////////////

#ifndef APSTUDIO_INVOKED
////////////////////////////////////
//
// Generated from the TEXTINCLUDE 3 resource.
//

////////////////////////////////////
#endif // not APSTUDIO_INVOKED

isapi_dll/src/tpcc.cpp

/*      FILE:          TPCC.C
 *
 *      Microsoft TPC-C Kit Ver. 4.20.000
 *      Copyright Microsoft, 1999
 *
 *      All Rights Reserved
 *
 *      Version 4.10.000 audited by Richard Gimarc,
 *      Performance Metrics, 3/17/99
 *
 *      PURPOSE:  Main module for TPCC.DLL which is an ISAPI service dll.
 *      Contact:  Charles Levine (clevine@microsoft.com)
 *
 *      Change history:
 *      4.20.000 - reworked error handling; added options for COM and Encina
 *      txn monitors
 */
```

```
*/
#include <windows.h>
#include <process.h>
#include <tchar.h>
#include <stdio.h>
#include <stdarg.h>
#include <malloc.h>
#include <stdlib.h>
#include <string.h>
#include <time.h>
#include <sys\timeb.h>
#include <io.h>
#include <assert.h>

#include <sqltypes.h>

#ifdef ICECAP
#include <icapexp.h>
#endif

#include "..\..\common\src\trans.h" //tpckit transaction header contains
definitions of structures specific to TPC-C
#include "..\..\common\src\error.h"
#include "..\..\common\src\txn_base.h"
#include "..\..\common\src\ReadRegistry.h"

#include "..\..\common\txnlog\include\rtetime.h"
#include "..\..\common\txnlog\include\spinlock.h"
#include "..\..\common\txnlog\include\txnlog.h"

// Database layer includes
#include "..\..\db_dblib_dll\src\tpcc_dblib.h" // DBLIB implementation of
TPC-C txns
#include "..\..\db_odbc_dll\src\tpcc_odbc.h" // ODBC implementation of
TPC-C txns

// Txn monitor layer includes
#include "..\..\tm_com_dll\src\tpcc_com.h" // COM Services
implementation on TPC-C txns
#include "..\..\tm_tuxedo_dll\src\tpcc_tux.h" // interface to Tuxedo
libraries
#include "..\..\tm_encina_dll\src\tpcc_enc.h" // interface to Encina
libraries

#include "httpext.h" //ISAPI DLL information
header
#include "tpcc.h" //this dlls specific
structure, value e.t. header.

#define LEN_ERR_STRING 256

// defines for Make<Txn>Form calls to distinguish input and output flavors
#define OUTPUT_FORM 0
#define INPUT_FORM 1

char szMyComputerName[MAX_COMPUTERNAME_LENGTH+1];

//Terminal client id structure
TERM Term = { 0, 0, 0, NULL };

// The WEBCLIENT_VERSION string specifies the version level of this web client interface.
```

Appendix A - Application Source Code

```
// The RTE must be synchronized with the interface level on login, otherwise the login
// will fail. This is a sanity check to catch problems resulting from mismatched
versions
// of the RTE and web client.
#define WEBCLIENT_VERSION "410"

static CRITICAL_SECTION TermCriticalSection;

static HINSTANCE hLibInstanceTm = NULL;
static HINSTANCE hLibInstanceDb = NULL;

TYPE_CTPCC_DBLIB *pCTPCC_DBLIB_new;
TYPE_CTPCC_ODBC *pCTPCC_ODBC_new;
TYPE_CTPCC_TUXEDO *pCTPCC_TUXEDO_new;
TYPE_CTPCC_ENCINA *pCTPCC_ENCINA_new;
TYPE_CTPCC_ENCINA *pCTPCC_ENCINA_post_init;
TYPE_CTPCC_COM *pCTPCC_COM_new;

// For deferred Delivery txns:

CTxnLog *pTxnLog; //used to log delivery transaction information *txnDelilog = NULL;

HANDLE hWorkerSemaphore = INVALID_HANDLE_VALUE;
HANDLE hDoneEvent = INVALID_HANDLE_VALUE;
HANDLE *pDeliHandles = NULL;

// configuration settings from registry
TPCCREGISTRYDATA Reg;

DWORD dwNumDeliveryThreads = 4;
CRITICAL_SECTION DelBuffCriticalSection; //critical section
DELIVERY_TRANSACTION *pDelBuff = NULL;
DWORD dwDelBuffSize = 100;
DWORD // size of circular buffer for delivery txns dwDelBuffFreeCount;
DWORD // number of buffers free dwDelBuffBusyIndex = 0;
DWORD // index position of entry waiting to be delivered dwDelBuffFreeIndex = 0;
DWORD // index position of unused entry

#include "..\..\common\src\ReadRegistry.cpp"

/* FUNCTION: DllMain
*
* PURPOSE: This function is the entry point for the DLL. This implementation is
based on the fact that DLL_PROCESS_ATTACH is only called from the inet
service once.
*
* ARGUMENTS: HANDLE hModule module handle
DWORD ul_reason_for_call reason for call
LPVOID lpReserved reserved for future use
*
* RETURNS: BOOL FALSE errors
occured in initialization
```

```
* TRUE
*/
DLL successfully initialized

BOOL WINAPI DllMain(HANDLE hModule, DWORD ul_reason_for_call, LPVOID lpReserved)
{
    DWORD i;
    char szEvent[LEN_ERR_STRING] = "\0";
    char szLogFile[128];
    char szDllName[128];

    // debugging...
    // DebugBreak();

    try
    {
        switch( ul_reason_for_call )
        {
            case DLL_PROCESS_ATTACH:
            {
                DWORD dwSize =
                MAX_COMPUTERNAME_LENGTH+1;
                GetComputerName(szMyComputerName,
                &dwSize);
                szMyComputerName[dwSize] = 0;

                DisableThreadLibraryCalls((HMODULE)hModule);
                InitializeCriticalSection(&TermCriticalSection);

                if ( ReadTPCCRegistrySettings( &Reg ) )
                    throw new CWEBCLNT_ERR(
                    ERR_MISSING_REGISTRY_ENTRIES );

                dwDelBuffSize = min( Reg.dwMaxPendingDeliveries,
                10000 ); // min with 10000 as a sanity constraint
                dwNumDeliveryThreads = min(
                Reg.dwNumberOfDeliveryThreads, 100 ); // min with 100 as a sanity constraint

                TermInit();

                // load DLL for txn monitor
                if (Reg.eTxnMon == TUXEDO)
                {
                    strcpy( szDllName, Reg.szPath );
                    strcat( szDllName, "tpcc_tuxedo.dll");
                    hLibInstanceTm = LoadLibrary( szDllName );

                    if (hLibInstanceTm == NULL)
                        throw new CWEBCLNT_ERR(
                        ERR_LOADDLL_FAILED, szDllName, GetLastError() );

                    // get function pointer to wrapper for
                    class constructor
                    pCTPCC_TUXEDO_new =
                    (TYPE_CTPCC_TUXEDO*) GetProcAddress(hLibInstanceTm, "CTPCC_TUXEDO_new");
                    if (pCTPCC_TUXEDO_new == NULL)
                        throw new CWEBCLNT_ERR(
                        ERR_GETPROCADDR_FAILED, szDllName, GetLastError() );
                }
                else if (Reg.eTxnMon == ENCINA)
                {
                    strcpy( szDllName, Reg.szPath );
                }
            }
        }
    }
}
```

Appendix A - Application Source Code

```
);
    strcat( szDllName, "tpcc_encina.dll");
    hLibInstanceTm = LoadLibrary( szDllName
);
    if (hLibInstanceTm == NULL)
        throw new CWBCLNT_ERR(
ERR_LOADDLL_FAILED, szDllName, GetLastError() );
// get function pointer to wrapper for
class constructor
    pCTPCC_ENCINA_new =
(TYPE_CTPCC_ENCINA*) GetProcAddress(hLibInstanceTm,"CTPCC_ENCINA_new");
    pCTPCC_ENCINA_post_init =
(TYPE_CTPCC_ENCINA*) GetProcAddress(hLibInstanceTm,"CTPCC_ENCINA_post_init");
    if (pCTPCC_ENCINA_new == NULL)
        throw new CWBCLNT_ERR(
ERR_GETPROCADDR_FAILED, szDllName, GetLastError() );
    }
    else if (Reg.eTxnMon == COM)
    {
        strcpy( szDllName, Reg.szPath );
        strcat( szDllName, "tpcc_com.dll");
        hLibInstanceTm = LoadLibrary( szDllName
);
    if (hLibInstanceTm == NULL)
        throw new CWBCLNT_ERR(
ERR_LOADDLL_FAILED, szDllName, GetLastError() );
// get function pointer to wrapper for
class constructor
    pCTPCC_COM_new = (TYPE_CTPCC_COM*)
GetProcAddress(hLibInstanceTm,"CTPCC_COM_new");
    if (pCTPCC_COM_new == NULL)
        throw new CWBCLNT_ERR(
ERR_GETPROCADDR_FAILED, szDllName, GetLastError() );
    }
// load DLL for database connection
if ((Reg.eTxnMon == None) ||
(dwNumDeliveryThreads > 0))
    {
        if (Reg.eDB_Protocol == DBLIB)
        {
            strcpy( szDllName, Reg.szPath
);
            strcat( szDllName,
"tpcc_dblib.dll");
            hLibInstanceDb = LoadLibrary(
szDllName );
            if (hLibInstanceDb == NULL)
                throw new
CWBCLNT_ERR( ERR_LOADDLL_FAILED, szDllName, GetLastError() );
// get function pointer to
wrapper for class constructor
            pCTPCC_DBLIB_new =
(TYPE_CTPCC_DBLIB*) GetProcAddress(hLibInstanceDb,"CTPCC_DBLIB_new");
            if (pCTPCC_DBLIB_new == NULL)
                throw new
CWBCLNT_ERR( ERR_GETPROCADDR_FAILED, szDllName, GetLastError() );
        }
        else if (Reg.eDB_Protocol == ODBC)
        {
            strcpy( szDllName, Reg.szPath
```

```

            strcat( szDllName,
"tpcc_odbc.dll");
            hLibInstanceDb = LoadLibrary(
szDllName );
            if (hLibInstanceDb == NULL)
                throw new
CWBCLNT_ERR( ERR_LOADDLL_FAILED, szDllName, GetLastError() );
// get function pointer to
wrapper for class constructor
            pCTPCC_ODBC_new =
(TYPE_CTPCC_ODBC*) GetProcAddress(hLibInstanceDb,"CTPCC_ODBC_new");
            if (pCTPCC_ODBC_new == NULL)
                throw new
CWBCLNT_ERR( ERR_GETPROCADDR_FAILED, szDllName, GetLastError() );
        }
    }
    if (dwNumDeliveryThreads)
    {
        // for deferred delivery txns:
        hDoneEvent = CreateEvent( NULL, TRUE /*
manual reset */, FALSE /* initially not signalled */, NULL );
        InitializeCriticalSection(&DelBuffCriticalSection);
        hWorkerSemaphore = CreateSemaphore(
NULL, 0, dwDelBuffSize, NULL );
        dwDelBuffFreeCount = dwDelBuffSize;
        InitJulianTime(NULL);
        // create unique log file name based on
delilog-yymmdd-hhmm.log
        SYSTEMTIME Time;
        GetLocalTime( &Time );
        wsprintf( szLogFile, "%sdelivery-
%2.2d%2.2d%2.2d-%2.2d%2.2d.log",
            Reg.szPath,
            Time.wYear % 100, Time.wMonth, Time.wDay, Time.wHour, Time.wMinute );
        txnDelilog = new CTxnLog(szLogFile,
TXN_LOG_WRITE);
        //write event into txn log for START
        txnDelilog-
>WriteCtrlRecToLog(TXN_EVENT_START, szMyComputerName, sizeof(szMyComputerName));
        // allocate structures for delivery
        buffers and thread mgmt
        pDeliHandles = new
HANDLE[dwNumDeliveryThreads];
        pDelBuff = new
DELIVERY_TRANSACTION[dwDelBuffSize];
        // launch DeliveryWorkerThread to
        perform actual delivery txns
        for(i=0; i<dwNumDeliveryThreads; i++)
        {
            pDeliHandles[i] = (HANDLE)
            if (pDeliHandles[i] ==
                throw new
            }
        }
        _beginthread( DeliveryWorkerThread, 0, NULL );
        INVALID_HANDLE_VALUE)
CWBCLNT_ERR( ERR_DELIVERY_THREAD_FAILED );
    }
```

Appendix A - Application Source Code

```
    }
    break;

case DLL_PROCESS_DETACH:
    if (dwNumDeliveryThreads)
    {
        if (txnDelilog != NULL)
        {
            //write event into txn log
            txnDelilog->WriteCtrlRecToLog(TXN_EVENT_STOP, szMyComputerName, sizeof(szMyComputerName));

            // This will do a clean
            CTxnLog *txnDelilogLocal =
            txnDelilog;
            delete txnDelilogLocal;

            delete [] pDeliHandles;
            delete [] pDelBuff;

            CloseHandle( hWorkerSemaphore );
            CloseHandle( hDoneEvent );

            DeleteCriticalSection(&DelBuffCriticalSection);
        }

        DeleteCriticalSection(&TermCriticalSection);

        if (hLibInstanceTm != NULL)
            FreeLibrary( hLibInstanceTm );
        hLibInstanceTm = NULL;

        if (hLibInstanceDb != NULL)
            FreeLibrary( hLibInstanceDb );
        hLibInstanceDb = NULL;

        Sleep(500);
        break;

    default:
        /* nothing */;
    }
}
catch (CBaseErr *e)
{
    WriteMessageToEventLog( e->ErrorText() );
    delete e;
    TerminateExtension(0);
    return FALSE;
}
catch (...)
{
    WriteMessageToEventLog(TEXT("Unhandled exception. DLL could not
load."));
    TerminateExtension(0);
    return FALSE;
}
}
```

```
    return TRUE;
}

/* FUNCTION: GetExtensionVersion
*
* PURPOSE: This function is called by the inet service when the DLL is first
loaded.
*
* ARGUMENTS: HSE_VERSION_INFO *pVer passed in structure in which to place
expected version number.
*
* RETURNS: TRUE inet service expected return value.
*/

BOOL WINAPI GetExtensionVersion(HSE_VERSION_INFO *pVer)
{
    pVer->dwExtensionVersion = MAKELONG(HSE_VERSION_MINOR, HSE_VERSION_MAJOR);
    lstrcpy(pVer->lpszExtensionDesc, "TPC-C Server.", HSE_MAX_EXT_DLL_NAME_LEN);

    // TODO: why do we need this here instead of in the DLL attach?
    if (Reg.eTxnMon == ENCINA)
        pCTPCC_ENCINA_post_init();

    return TRUE;
}

/* FUNCTION: TerminateExtension
*
* PURPOSE: This function is called by the inet service when the DLL is about to
be unloaded.
*
* ARGUMENTS: Release all resources in anticipation of being unloaded.
*
* RETURNS: TRUE inet service expected return value.
*/

BOOL WINAPI TerminateExtension( DWORD dwFlags )
{
    if (pDeliHandles)
    {
        SetEvent( hDoneEvent );
        for(DWORD i=0; i<dwNumDeliveryThreads; i++)
            WaitForSingleObject( pDeliHandles[i], INFINITE );
    }

    TermDeleteAll();
    return TRUE;
}

/* FUNCTION: HttpExtensionProc
*
* PURPOSE: This function is the main entry point for the TPCC DLL. The internet
service
calls this function passing in the http string.
*
* ARGUMENTS: EXTENSION_CONTROL_BLOCK *pECB structure pointer to passed
in internet
service information.
*
* RETURNS: DWORD HSE_STATUS_SUCCESS
connection can be dropped if error
*/
```

Appendix A - Application Source Code

```
*
      HSE_STATUS_SUCCESS_AND_KEEP_CONN      keep connect valid comment sent
*
* COMMENTS:      None
*/
DWORD WINAPI HttpExtensionProc(EXTENSION_CONTROL_BLOCK *pECB)
{
    int          iCmd, FormId, TermId, iSyncId;
    char          szBuffer[4096];

    int          lpbSize;
    static char  szHeader[] = "200 Ok";
    DWORD        dwSize = 6;           // initial value is
strlen(szHeader)
    char          szHeader1[4096];

#ifdef ICECAP
    StartCAP();
#endif

    try
    {
        //process http query
        ProcessQueryString(pECB, &iCmd, &FormId, &TermId, &iSyncId);

        if (TermId != 0)
        {
            if ( TermId < 0 || TermId >= Term.iNumEntries ||
Term.pClientData[TermId].iNextFree != -1 )
            {
                // debugging...
                char szTmp[128];
                wsprintf( szTmp, "Invalid term ID; TermId = %d",
TermId );
                WriteMessageToEventLog( szTmp );
                throw new CWEBCLNT_ERR( ERR_INVALID_TERMID );
            }

            //must have a valid syncid here since termid is valid
            if (iSyncId != Term.pClientData[TermId].iSyncId)
                throw new CWEBCLNT_ERR(
ERR_INVALID_SYNC_CONNECTION );

            //set use time
            Term.pClientData[TermId].iTickCount = GetTickCount();
        }

        switch(iCmd)
        {
        case 0:
            WelcomeForm(pECB, szBuffer);
            break;

        case 1:
            switch( FormId )
            {
                case WELCOME_FORM:
                case MAIN_MENU_FORM:
                    break;
            }
        }
    }
}
```

```
szBuffer);

szBuffer);

szBuffer);

szBuffer);

szBuffer);

szBuffer);

}
break;
case 2:
    // new-order selected from menu; display new-order input
form
    MakeNewOrderForm(TermId, NULL, INPUT_FORM, szBuffer);
    break;
case 3:
    // payment selected from menu; display payment input form
    MakePaymentForm(TermId, NULL, INPUT_FORM, szBuffer);
    break;
case 4:
    // delivery selected from menu; display delivery input form
    MakeDeliveryForm(TermId, NULL, INPUT_FORM, szBuffer);
    break;
case 5:
    // order-status selected from menu; display order-status
input form
    MakeOrderStatusForm(TermId, NULL, INPUT_FORM, szBuffer);
    break;
case 6:
    // stock-level selected from menu; display stock-level
input form
    MakeStockLevelForm(TermId, NULL, INPUT_FORM, szBuffer);
    break;
case 7:
    // ExitCmd
    TermDelete(TermId);
    WelcomeForm(pECB, szBuffer);
    break;
case 8:
    SubmitCmd(pECB, szBuffer);
    break;
case 9:
    // menu
    MakeMainMenuForm(TermId, Term.pClientData[TermId].iSyncId,
szBuffer);
    break;
case 10:
    // CMD=Clear
    // resets all connections; should only be used when no
other connections are active
    TermDeleteAll();
}
```

Appendix A - Application Source Code

```

                TermInit();
                WelcomeForm(pECB, szBuffer);
                break;
        case 11: // CMD=Stats
                StatsCmd(pECB, szBuffer);
                break;
        }
    }
    catch (CBaseErr *e)
    {
        ErrorForm( pECB, e->ErrorType(), e->ErrorNum(), TermId, iSyncId, e-
>ErrorText(), szBuffer );
        delete e;
    }
    catch (...)
    {
        ErrorForm( pECB, ERR_TYPE_WEBDLL, 0, TermId, iSyncId, "Error:
Unhandled exception in Web Client.", szBuffer );
    }

#ifdef ICECAP
    StopCAP();
#endif

    lpbSize = strlen(szBuffer);
    wsprintf(szHeader1,
            "Content-Type: text/html\r\n"
            "Content-Length: %d\r\n"
            "Connection: Keep-Alive\r\n\r\n", lpbSize);
    strcat( szHeader1, szBuffer );

    (*pECB->ServerSupportFunction)(pECB->ConnID, HSE_REQ_SEND_RESPONSE_HEADER,
szHeader, (LPDWORD) &dwSize, (LPDWORD)szHeader1);

    //finish up and keep connection
    pECB->dwHttpStatusCode = 200;
    return HSE_STATUS_SUCCESS_AND_KEEP_CONN;
}

void WriteMessageToEventLog(LPTSTR lpszMsg)
{
    TCHAR    szMsg[256];
    HANDLE   hEventSource;
    LPTSTR   lpszStrings[2];

    // Use event logging to log the error.
    //
    hEventSource = RegisterEventSource(NULL, TEXT("TPCC.DLL"));

    _stprintf(szMsg, TEXT("Error in TPCC.DLL: "));
    lpszStrings[0] = szMsg;
    lpszStrings[1] = lpszMsg;

    if (hEventSource != NULL)
    {
        ReportEvent(hEventSource, // handle of event source
            EVENTLOG_ERROR_TYPE, // event type
            0, // event category
            0, // event ID
            NULL, // current user's SID
            2, // strings in lpszStrings

```

```

        0, // no bytes of raw data
        (LPCTSTR *)lpszStrings, // array of error strings
        NULL); // no raw data
    }
    (VOID) DeregisterEventSource(hEventSource);
}

/* FUNCTION: DeliveryWorkerThread
 * PURPOSE: This function processes deferred delivery txns. There are typically
several threads running this routine. The number of threads is
determined by an entry read from the registry. The thread waits for work by
waiting on semaphore. When a delivery txn is posted, the semaphore is released.
After processing the delivery txn, information is logged to record the txn
status and execution time.
 */

/*static*/ void DeliveryWorkerThread(void *ptr)
{
    CTPCC_BASE *pTxn = NULL;

    DELIVERY_TRANSACTION delivery;
    PDELIVERY_DATA pDeliveryData;
    TXN_RECORD_TPCC_DELIV_DEF txnDeliRec;

    DWORD index;
    HANDLE handles[2];

    SYSTEMTIME trans_end; //delivery
    transaction finished time
    SYSTEMTIME trans_start; //delivery transaction start
    time

    assert(txnDeliRec != NULL);

    try
    {
        if (Reg.eDB_Protocol == ODBC)
            pTxn = pCTPCC_ODBC_new( Reg.szDbServer, Reg.szDbUser,
Reg.szDbPassword, szMyComputerName, Reg.szDbName );
        else if (Reg.eDB_Protocol == DBLIB)
            pTxn = pCTPCC_DBLIB_new( Reg.szDbServer, Reg.szDbUser,
Reg.szDbPassword, szMyComputerName, Reg.szDbName );
        pDeliveryData = pTxn->BuffAddr_Delivery();
    }
    catch (CBaseErr *e)
    {
        char szTmp[1024];
        wsprintf( szTmp, "Error in Delivery Txn thread. Could not connect to
database. "
            "%s. Server=%s, User=%s, Password=%s,
            Database=%s",
            e->ErrorText(), Reg.szDbServer, Reg.szDbUser,
Reg.szDbPassword, Reg.szDbName );
        WriteMessageToEventLog( szTmp );
        delete e;
    }
}

```

Appendix A - Application Source Code

```
        goto ErrorExit;
    }
    catch (...)
    {
        WriteMessageToEventLog(TEXT("Unhandled exception caught in
DeliveryWorkerThread."));
        goto ErrorExit;
    }

    while (TRUE)
    {
        try
        {
            //while delivery thread running, i.e. user has not
            // need to wait for multiple objects: program
            while (TRUE)
            {
                handles[0] = hDoneEvent;
                handles[1] = hWorkerSemaphore;
                index = WaitForMultipleObjects( 2, &handles[0],
                FALSE, INFINITE );

                if (index == WAIT_OBJECT_0)
                    goto ErrorExit;

                ZeroMemory(&txnDeliRec, sizeof(txnDeliRec));
                txnDeliRec.TxnType = TXN_REC_TYPE_TPCC_DELIV_DEF;

                // make a local copy of current entry from
                // delivery buffer and increment buffer index
                EnterCriticalSection(&DelBuffCriticalSection);
                delivery = *(pDelBuff+dwDelBuffBusyIndex);
                dwDelBuffFreeCount++;
                dwDelBuffBusyIndex++;
                if (dwDelBuffBusyIndex == dwDelBuffSize)
                    // wrap-around if at end of buffer
                    dwDelBuffBusyIndex = 0;

                LeaveCriticalSection(&DelBuffCriticalSection);

                pDeliveryData->w_id = delivery.w_id;
                pDeliveryData->o_carrier_id =
                delivery.o_carrier_id;

                txnDeliRec.w_id = pDeliveryData->w_id;
                txnDeliRec.o_carrier_id = pDeliveryData->
                o_carrier_id;

                txnDeliRec.TxnStartT0 =
                Get64BitTime(&delivery.queue);

                GetLocalTime( &trans_start );
                pTxn->Delivery();
                GetLocalTime( &trans_end );

                //log txn
                txnDeliRec.TxnStatus = ERR_SUCCESS;
                for (int i=0; i<10; i++)
                    txnDeliRec.o_id[i] = pDeliveryData->
                    o_id[i];

                txnDeliRec.DeltaT4 =
                (int)(Get64BitTime(&trans_end) - txnDeliRec.TxnStartT0);
```

```
                txnDeliRec.DeltaTxnExec =
                (int)(Get64BitTime(&trans_end) - Get64BitTime(&trans_start));

                if (txnDeliLog != NULL)
                    txnDeliLog->WriteToLog(&txnDeliRec);
            }
        }
        catch (CBaseErr *e)
        {
            char szTmp[1024];
            wsprintf( szTmp, "Error in Delivery Txn thread. %s", e-
            >ErrorText() );

            WriteMessageToEventLog( szTmp );

            // log the error txn
            txnDeliRec.TxnStatus = e->ErrorType();
            if (txnDeliLog != NULL)
                txnDeliLog->WriteToLog(&txnDeliRec);

            delete e;
        }
        catch (...)
        {
            // unhandled exception; shouldn't happen; not much we can
            // do...
            WriteMessageToEventLog(TEXT("Unhandled exception caught in
DeliveryWorkerThread."));
        }
    }

    ErrorExit:
        delete pTxn;
        _endthread();
}

/* FUNCTION: PostDeliveryInfo
 *
 * PURPOSE:          This function enters the delivery txn into the deferred delivery
 *                   buffer.
 *
 * RETURNS:          BOOL      FALSE      delivery information posted
 *                   successfully
 *                   TRUE       error cannot post
 *
 * delivery info
 */
BOOL PostDeliveryInfo(short w_id, short o_carrier_id)
{
    BOOL bError;

    EnterCriticalSection(&DelBuffCriticalSection);
    if (dwDelBuffFreeCount > 0)
    {
        bError = FALSE;
        (pDelBuff+dwDelBuffFreeIndex)->w_id          = w_id;
        (pDelBuff+dwDelBuffFreeIndex)->o_carrier_id   = o_carrier_id;
        GetLocalTime(&(pDelBuff+dwDelBuffFreeIndex)->queue);

        dwDelBuffFreeCount--;
        dwDelBuffFreeIndex++;
        if (dwDelBuffFreeIndex == dwDelBuffSize)
            dwDelBuffFreeIndex = 0;
        // wrap-around if
        // at end of buffer
```

Appendix A - Application Source Code

```
    }
    else
        // No free buffers. Return an error, which indicates that the
        // delivery buffer is full.
        // Most likely, the number of delivery worker threads needs to be
        // increased to keep up
        // with the txn rate.
        bError = TRUE;
        LeaveCriticalSection(&DelBuffCriticalSection);

        if (!bError)
            // increment worker semaphore to wake up a worker thread
            ReleaseSemaphore( hWorkerSemaphore, 1, NULL );

        return bError;
    }

/* FUNCTION: ProcessQueryString
 *
 * PURPOSE:      This function extracts the relevent information out of the http
 *               command passed in from
 *               the browser.
 *
 * COMMENTS:     If this is the initial connection i.e. client is at welcome screen
 *               then
 *               there will not be a terminal id or current form
 *               id. If this is the case
 *               then the pTermid and pFormid return values are
 *               undefined.
 */

void ProcessQueryString(EXTENSION_CONTROL_BLOCK *pECB, int *pCmd, int *pFormId, int
*pTermId, int *pSyncId)
{
    char *ptr = pECB->lpszQueryString;
    char szBuffer[25];
    int i;

    //allowable client command strings i.e. CMD=command
    static char *szCmds[] =
    {
        "Process", "..NewOrder..", "..Payment..", "..Delivery..", "..Order-
        Status..", "..Stock-Level..",
        "..Exit..", "Submit", "Menu", "Clear", "Stats", ""
    };

    *pCmd = 0; // default is the login screen
    *pTermId = 0;

    // if no params (i.e., empty query string), then return login screen
    if (strlen(pECB->lpszQueryString) == 0)
        return;

    // parse FORMID, TERMID, and SYNCID
    *pFormId = GetIntKeyValue(&ptr, "FORMID", NO_ERR, NO_ERR);
    *pTermId = GetIntKeyValue(&ptr, "TERMID", NO_ERR, NO_ERR);
    *pSyncId = GetIntKeyValue(&ptr, "SYNCID", NO_ERR, NO_ERR);

    // parse CMD
    GetKeyValue(&ptr, "CMD", szBuffer, sizeof(szBuffer), ERR_COMMAND_UNDEFINED);

    // see which command it matches
    for(i=0; ; i++)
```

```
    {
        if (szCmds[i][0] == 0)
            // no more; no match; return error
            throw new CWEBCLNT_ERR( ERR_COMMAND_UNDEFINED );
        if ( !strcmp(szCmds[i], szBuffer) )
            {
                *pCmd = i+1;
                break;
            }
    }

/* FUNCTION: void WelcomeForm
 *
 */

void WelcomeForm(EXTENSION_CONTROL_BLOCK *pECB, char *szBuffer)
{
    char szTmp[1024];

    //welcome to tpc-c html form buffer, this is first form client sees.
    strcpy( szBuffer, "<HTML><HEAD><TITLE>TPC-C Web Client</TITLE></HEAD><BODY>"
        "<B><BIG>Microsoft TPC-C Web
Client (ver 4.20)</BIG></B> <BR> <BR>"
        "<font face=\"Courier
New\"><PRE>"
        "Compiled: \"__DATE__",
        "\"__TIME__\" <BR>"
        "Source: \"__FILE__"
        "\"</PRE></font>"
        "<FORM ACTION=\"tpcc.dll\"
METHOD=\"GET\">"
        "<INPUT TYPE=\"hidden\"
NAME=\"STATUSID\" VALUE=\"0\">"
        "<INPUT TYPE=\"hidden\"
NAME=\"ERROR\" VALUE=\"0\">"
        "<INPUT TYPE=\"hidden\"
NAME=\"FORMID\" VALUE=\"1\">"
        "<INPUT TYPE=\"hidden\"
NAME=\"TERMID\" VALUE=\"0\">"
        "<INPUT TYPE=\"hidden\"
NAME=\"SYNCID\" VALUE=\"0\">"
        "<INPUT TYPE=\"hidden\"
NAME=\"VERSION\" VALUE=\"\" WEBCLIENT_VERSION \">"
        );

    sprintf( szTmp, "Configuration Settings: <BR><font face=\"Courier New\"
color=\"blue\"><PRE>"
        "Txn Monitor =
<B>%s</B><BR>"
        "Database protocol =
<B>%s</B><BR>"
        "Max Connections =
<B>%d</B><BR>"
        "# of Delivery Threads =
<B>%d</B><BR>"
        "Max Pending Deliveries =
<B>%d</B><BR>"
        , szTxnMonNames[Reg.eTxnMon], szDBNames[Reg.eDB_Protocol],
        Reg.dwMaxConnections, dwNumDeliveryThreads, dwDelBuffSize
    );

    strcat( szBuffer, szTmp);
```

Appendix A - Application Source Code

```
if (Reg.eTxnMon == COM)
{
    sprintf( szTmp, "COM Single Pool = <B>%s</B><BR>",
            Reg.bCOM_SinglePool ? "YES" : "NO" );
    strcat( szBuffer, szTmp);
}
strcat( szBuffer, "</PRE></font>");

if (Reg.eTxnMon == None)
// connection options may be specified when not using a txn monitor
    sprintf( szTmp, "Please enter your database options for this
connection:<BR>"
color="\blue"><PRE>"
                                "<font face=\\"Courier New\\"
                                "DB Server = <INPUT
                                "DB User ID = <INPUT
NAME=\\"db_server\\" SIZE=20 VALUE=\\"%s\\"><BR>"
                                "DB Password = <INPUT
NAME=\\"db_user\\" SIZE=20 VALUE=\\"%s\\"><BR>"
                                "DB Name = <INPUT
NAME=\\"db_passwd\\" SIZE=20 VALUE=\\"%s\\"><BR>"
                                "</PRE></font>"
                                , Reg.szDbServer, Reg.szDbUser,
                                Reg.szDbPassword, Reg.szDbName );
    else
// if using a txn monitor, connection options are determined from
registry; can't
// set per user. show options fyi
    sprintf( szTmp, "Database options which will be used by the
transaction monitor:<BR>"
color="\blue"><PRE>"
                                "<font face=\\"Courier New\\"
                                "DB Server =
                                "DB User ID =
                                "DB Password =
                                "DB Name =
                                "</PRE></font>"
                                , Reg.szDbServer, Reg.szDbUser,
                                Reg.szDbPassword, Reg.szDbName );
    strcat( szBuffer, szTmp);

    sprintf( szTmp, "Please enter your Warehouse and District for this
session:<BR>"
color="\blue"><PRE>" );
    strcat( szBuffer, szTmp);
    strcat( szBuffer, "Warehouse ID = <INPUT NAME=\\"w_id\\" SIZE=4><BR>"
NAME=\\"d_id\\" SIZE=2><BR>"
                                "District ID = <INPUT
                                "</PRE></font><HR>"
                                "<INPUT TYPE=\\"submit\\"
NAME=\\"CMD\\" VALUE=\\"Submit\\">"
                                "</FORM></BODY></HTML>");
}

/* FUNCTION: SubmitCmd
*
```

```
* PURPOSE: This function allocated a new terminal id in the Term structure
array.
*/

void SubmitCmd(EXTENSION_CONTROL_BLOCK *pECB, char *szBuffer)
{
    int iNewTerm;
    char *ptr = pECB->lpszQueryString;

    char szVersion[32] = { 0 };
    char szServer[32] = { 0 };
    char szUser[32] = "sa";
    char szPassword[32] = { 0 };
    char szDatabase[32] = "tpcc";

    // validate version field; the version field ensures that the RTE is
synchronized with the web client
    GetKeyValue(&ptr, "VERSION", szVersion, sizeof(szVersion),
ERR_VERSION_MISMATCH);
    if ( strcmp( szVersion, WEBCLIENT_VERSION ) )
        throw new CWBCLNT_ERR( ERR_VERSION_MISMATCH );

    if (Reg.eTxnMon == None)
    {
        // parse Server name
        GetKeyValue(&ptr, "db_server", szServer, sizeof(szServer),
ERR_NO_SERVER_SPECIFIED);
        // parse User name
        GetKeyValue(&ptr, "db_user", szUser, sizeof(szUser), NO_ERR);
        // parse Password
        GetKeyValue(&ptr, "db_passwd", szPassword, sizeof(szPassword),
NO_ERR);
        // parse Database name
        GetKeyValue(&ptr, "db_name", szDatabase, sizeof(szDatabase), NO_ERR);

        // parse warehouse ID
        int w_id = GetIntKeyValue(&ptr, "w_id", ERR_HTML_ILL_FORMED, ERR_W_ID_INVALID);
        if ( w_id < 1 )
            throw new CWBCLNT_ERR( ERR_W_ID_INVALID );

        // parse district ID
        int d_id = GetIntKeyValue(&ptr, "d_id", ERR_HTML_ILL_FORMED, ERR_D_ID_INVALID);
        if ( d_id < 1 || d_id > 10 )
            throw new CWBCLNT_ERR( ERR_D_ID_INVALID );

        iNewTerm = TermAdd();
        Term.pClientData[iNewTerm].w_id = w_id;
        Term.pClientData[iNewTerm].d_id = d_id;

        try
        {
            if (Reg.eTxnMon == TUXEDO)
                Term.pClientData[iNewTerm].pTxn = pCTPCC_TUXEDO_new();
            else if (Reg.eTxnMon == ENCINA)
                Term.pClientData[iNewTerm].pTxn = pCTPCC_ENCINA_new();
            else if (Reg.eTxnMon == COM)
                Term.pClientData[iNewTerm].pTxn = pCTPCC_COM_new(
Reg.bCOM_SinglePool );
            else if (Reg.eDB_Protocol == ODBC)
```

Appendix A - Application Source Code

```

        Term.pClientData[iNewTerm].pTxn = pCTPCC_ODBC_new(
szServer, szUser, szPassword, szMyComputerName, szDatabase );
        else if (Reg.eDB_Protocol == DBLIB)
            Term.pClientData[iNewTerm].pTxn = pCTPCC_DBLIB_new(
szServer, szUser, szPassword, szMyComputerName, szDatabase );
    }
    catch (...)
    {
        TermDelete(iNewTerm);
        throw; // pass exception upward
    }

    MakeMainMenuForm(iNewTerm, Term.pClientData[iNewTerm].iSyncId, szBuffer);
}

/* FUNCTION: StatsCmd
 *
 * PURPOSE: This function returns to the browser the total number of active
terminal ids.
 *          This routine is for development/debugging purposes.
 *
 */

void StatsCmd(EXTENSION_CONTROL_BLOCK *pECB, char *szBuffer)
{
    int i;
    int iTotals;

    EnterCriticalSection(&TermCriticalSection);

    iTotals = 0;
    for(i=0; i<Term.iNumEntries; i++)
    {
        if (Term.pClientData[i].iNextFree == -1)
            iTotals++;
    }

    LeaveCriticalSection(&TermCriticalSection);

    wprintf( szBuffer,
        "<HTML><HEAD><TITLE>TPC-C Web Client Stats</TITLE></HEAD>"
        "<BODY><B><BIG> Total Active Connections: %d"
        , iTotals );
}

char *CWEBCLNT_ERR::ErrorText()
{
    static SERRORMSG errorMsgs[] =
    {
        { ERR_COMMAND_UNDEFINED,
        "Command undefined." },
        { ERR_D_ID_INVALID,
        "Invalid District ID Must be 1 to 10." },
        { ERR_DELIVERY_CARRIER_ID_RANGE,
        "Delivery Carrier ID out of range must be 1 - 10." },
        { ERR_DELIVERY_CARRIER_INVALID,
        "Delivery
Carrier ID invalid must be numeric 1 - 10." }
    }
}

```

```

    { ERR_DELIVERY_MISSING_OCD_KEY,
    "Delivery
missing Carrier ID key \"OCD*\"." },
    { ERR_DELIVERY_THREAD_FAILED,
    "Could not start delivery worker thread." },
    { ERR_GETPROCADDR_FAILED,
    "Could not map proc in DLL. GetProcAddr error. DLL=" },
    { ERR_HTML_ILL_FORMED,
    "Required key field is missing from HTML string." },
    { ERR_INVALID_SYNC_CONNECTION,
    "Invalid
Terminal Sync ID." },
    { ERR_INVALID_TERMINID,
    "Invalid Terminal ID." },
    { ERR_LOADDLL_FAILED,
    "Load of DLL failed. DLL=" },
    { ERR_MAX_CONNECTIONS_EXCEEDED,
    "No
connections available. Max Connections is probably too low." },
    { ERR_MISSING_REGISTRY_ENTRIES,
    "Required
registry entries are missing. Rerun INSTALL to correct." },
    { ERR_NEWORDER_CUSTOMER_INVALID,
    "New Order customer id invalid data type, range = 1 to 3000." },
    { ERR_NEWORDER_CUSTOMER_KEY,
    "New Order missing Customer key \"CID*\"." },
    { ERR_NEWORDER_DISTRICT_INVALID,
    "New Order District ID Invalid range 1 - 10." },
    { ERR_NEWORDER_FORM_MISSING_DID,
    "New Order missing District key \"DID*\"." },
    { ERR_NEWORDER_ITEMID_INVALID,
    "New
Order Item Id is wrong data type, must be numeric." },
    { ERR_NEWORDER_ITEMID_RANGE,
    "New Order Item Id is out of range. Range = 1 to 999999." },
    { ERR_NEWORDER_ITEMID_WITHOUT_SUPPW,
    "New
Order Item_Id field entered without a corresponding Supp_W." },
    { ERR_NEWORDER_MISSING_IID_KEY,
    "New
Order missing Item Id key \"IID*\"." },
    { ERR_NEWORDER_MISSING_QTY_KEY,
    "New
Order Missing Qty key \"Qty##*\"." },
    { ERR_NEWORDER_MISSING_SUPPW_KEY,
    "New Order missing Supp_W key \"SP##*\"." },
    { ERR_NEWORDER_NOITEMS_ENTERED,
    "New
Order No order lines entered." },
    { ERR_NEWORDER_QTY_INVALID,
    "New Order Qty invalid must be numeric range 1 - 99." },
    { ERR_NEWORDER_QTY_RANGE,
    "New Order Qty is out of range. Range = 1 to 99." }
}

```

Appendix A - Application Source Code

```

        {
            ERR_NEWORDER_QTY_WITHOUT_SUPPW,
            "New Order Qty field entered without a corresponding Supp_W."
        },
        {
            ERR_NEWORDER_SUPPW_INVALID,
            "New Order Supp_W invalid data type must be numeric."
        },
        {
            ERR_NO_SERVER_SPECIFIED,
            "No Server name specified."
        },
        {
            ERR_ORDERSTATUS_CID_AND_CLT,
            "Order Status Only Customer ID or Last Name may be entered, not both."
        },
        {
            ERR_ORDERSTATUS_CID_INVALID,
            "Order Status Customer ID invalid, range must be numeric 1 - 3000."
        },
        {
            ERR_ORDERSTATUS_CLT_RANGE,
            "Order Status Customer last name longer than 16 characters."
        },
        {
            ERR_ORDERSTATUS_DID_INVALID,
            "Order Status District invalid, value must be numeric 1 - 10."
        },
        {
            ERR_ORDERSTATUS_MISSING_CID_CLT,
            "Order Status Either Customer ID or Last Name must be entered."
        },
        {
            ERR_ORDERSTATUS_MISSING_CID_KEY,
            "Order Status missing Customer key \"CID*\"."
        },
        {
            ERR_ORDERSTATUS_MISSING_CLT_KEY,
            "Order Status missing Customer Last Name key \"CLT*\"."
        },
        {
            ERR_ORDERSTATUS_MISSING_DID_KEY,
            "Order Status missing District key \"DID*\"."
        },
        {
            ERR_PAYMENT_CDI_INVALID,
            "Payment Customer district invalid must be numeric."
        },
        {
            ERR_PAYMENT_CID_AND_CLT,
            "Payment Only Customer ID or Last Name may be entered, not both."
        },
        {
            ERR_PAYMENT_CUSTOMER_INVALID,
            "Payment Customer data type invalid, must be numeric."
        },
        {
            ERR_PAYMENT_CWI_INVALID,
            "Payment Customer Warehouse invalid, must be numeric."
        },
        {
            ERR_PAYMENT_DISTRICT_INVALID,
            "Payment District ID is invalid, must be 1 - 10."
        },
        {
            ERR_PAYMENT_HAM_INVALID,
            "Payment Amount invalid data type must be numeric."
        },
        {
            ERR_PAYMENT_HAM_RANGE,
            "Payment Amount out of range, 0 - 9999.99."
        },
        {
            ERR_PAYMENT_LAST_NAME_TO_LONG,
            "Payment Customer last name longer than 16 characters."
        },
        {
            ERR_PAYMENT_MISSING_CDI_KEY,
            "Payment missing Customer district key \"CDI*\"."
        },
        {
            ERR_PAYMENT_MISSING_CID_CLT,
            "Payment Either Customer ID or Last Name must be entered."
        },
        {
            ERR_PAYMENT_MISSING_CID_KEY,
            "Payment missing Customer Key \"CID*\"."
        },
        {
            ERR_PAYMENT_MISSING_CLT_KEY,
            "Payment missing Customer Last Name key \"CLT*\"."
        },
        {
            ERR_PAYMENT_MISSING_CWI_KEY,
            "Payment missing Customer Warehouse key \"CWI*\"."
        },
        {
            ERR_PAYMENT_MISSING_DID_KEY,
            "Payment missing District Key \"DID*\"."
        },
        {
            ERR_PAYMENT_MISSING_HAM_KEY,
            "Payment missing Amount key \"HAM*\"."
        },
        {
            ERR_STOCKLEVEL_MISSING_THRESHOLD_KEY,
            "Stock Level; missing Threshold key \"TT*\"."
        },
        {
            ERR_STOCKLEVEL_THRESHOLD_INVALID,
            "Stock Level; Threshold value must be in the range = 1 - 99."
        },
        {
            ERR_STOCKLEVEL_THRESHOLD_RANGE,
            "Stock Level Threshold out of range, range must be 1 - 99."
        },
        {
            ERR_VERSION_MISMATCH,
            "Invalid version field. RTE and Web Client are probably out of sync."
        },
        {
            ERR_W_ID_INVALID,
            "Invalid Warehouse ID."
        },
        {
            0,
            ""
        }
    };

    char szTmp[256];
    int i = 0;
    while (TRUE)
    {
        if (errorMsgs[i].szMsg[0] == 0)
        {
            strcpy( szTmp, "Unknown error number." );
            break;
        }
        if (m_Error == errorMsgs[i].iError)
        {
            strcpy( szTmp, errorMsgs[i].szMsg );
            break;
        }
        i++;
    }

    if (m_szTextDetail)
        strcat( szTmp, m_szTextDetail );
    if (m_SystemErr)
        sprintf( szTmp+strlen(szTmp), " Error=%d", m_SystemErr );

    m_szErrorText = new char[strlen(szTmp)+1];
    strcpy( m_szErrorText, szTmp );
    return m_szErrorText;
}

/* FUNCTION: GetKeyValue
 * PURPOSE:      This function parses a http formatted string for specific key values.
 * ARGUMENTS:   char *pQueryString http string from client browser

```

Appendix A - Application Source Code

```
*
*   key value to look for      char      *pKey
*   character array into which to place key's value
*   maximum length of key value array.
*   error value to throw      WEBERROR   err
* RETURNS:                    nothing.
* ERROR:                      if (the pKey value is not found) then
*                             if (err == 0)
*                             return (empty string)
*                             else
*                             throw CWEBCLNT_ERR(err)
* COMMENTS:                  http keys are formatted either KEY=value& or KEY=value\0. This DLL
*                             formats
*                             TPC-C input fields in such a manner that the keys
*                             can be extracted in the
*                             above manner.
*/

void GetKeyValue(char **pQueryString, char *pKey, char *pValue, int iMax, WEBERROR err)
{
    char *ptr;

    if ( !(ptr=strstr(*pQueryString, pKey)) )
        goto ErrorExit;
    ptr += strlen(pKey);
    if ( *ptr != '=' )
        goto ErrorExit;
    ptr++;

    iMax--; // one position is for terminating null
    while( *ptr && *ptr != '&' && iMax )
    {
        *pValue++ = *ptr++;
        iMax--;
    }
    *pValue = 0; // terminating null

    *pQueryString = ptr;
    return;

ErrorExit:
    if (err != NO_ERR)
        throw new CWEBCLNT_ERR( err );
    *pValue = 0; // return empty result string
}

/* FUNCTION: GetIntKeyValue
*
* PURPOSE:      This function parses a http formatted string for a specific key
* value.
*
* ARGUMENTS:   char      *pQueryString      http string from
* client browser
*
*              char      *pKey
*
*              WEBERROR   NoKeyErr         error
* value to throw if key not found
*/
```

```
*
*   value to throw if value not numeric
* RETURNS:      integer
* ERROR:        if (the pKey value is not found) then
*               if (NoKeyErr != NO_ERR)
*               throw CWEBCLNT_ERR(err)
*               else
*               return 0
*               else if (non-numeric char found) then
*               if (NotIntErr != NO_ERR) then
*               throw CWEBCLNT_ERR(err)
*               else
*               return 0
* COMMENTS:     http keys are formatted either KEY=value& or KEY=value\0. This DLL
* formats
*               TPC-C input fields in such a manner that the keys
* can be extracted in the
*               above manner.
*/

int GetIntKeyValue(char **pQueryString, char *pKey, WEBERROR NoKeyErr, WEBERROR
NotIntErr)
{
    char *ptr0;
    char *ptr;

    if ( !(ptr=strstr(*pQueryString, pKey)) )
        goto ErrorNoKey;
    ptr += strlen(pKey);
    if ( *ptr != '=' )
        goto ErrorNoKey;
    ptr++;

    ptr0 = ptr; // remember starting point
    // scan string until a terminator (null or &) or a non-digit
    while( *ptr && *ptr != '&' && isdigit(*ptr) )
        ptr++;

    // make sure we stopped scanning for the right reason
    if ((ptr0 == ptr) || (*ptr && *ptr != '&'))
    {
        if (NotIntErr != NO_ERR)
            throw new CWEBCLNT_ERR( NoKeyErr );
        return 0;
    }

    *pQueryString = ptr;
    return atoi(ptr0);

ErrorNoKey:
    if (NoKeyErr != NO_ERR)
        throw new CWEBCLNT_ERR( NoKeyErr );
    return 0;
}

/* FUNCTION: TermInit
*
* PURPOSE:     This function initializes the client terminal structure; it is called
* when the TPCC.DLL
*              is first loaded by the inet service.
*/
```

Appendix A - Application Source Code

```
*
*/
void TermInit(void)
{
    EnterCriticalSection(&TermCriticalSection);

    Term.iMasterSyncId = 1;
    Term.iNumEntries = Reg.dwMaxConnections+1;

    Term.pClientData = NULL;
    Term.pClientData = (PCLIENTDATA)malloc(Term.iNumEntries *
sizeof(CLIENTDATA));
    if (Term.pClientData == NULL)
    {
        LeaveCriticalSection(&TermCriticalSection);
        throw new CWEBCLNT_ERR( ERR_MEM_ALLOC_FAILED );
    }

    ZeroMemory( Term.pClientData, Term.iNumEntries * sizeof(CLIENTDATA) );

    Term.iFreeList = Term.iNumEntries-1;
    // build free list
    // note: Term.pClientData[0].iNextFree gets set to -1, which marks it as "in
use".
    // This is intentional, as the zero entry is used as an anchor and never
    // allocated as an actual terminal.
    for(int i=0; i<Term.iNumEntries; i++)
        Term.pClientData[i].iNextFree = i-1;

    LeaveCriticalSection(&TermCriticalSection);
}

/* FUNCTION: TermDeleteAll
*
* PURPOSE: This function frees allocated resources associated with the terminal
structure.
*
* ARGUMENTS: none
*
* RETURNS: None
*
* COMMENTS: This function is called only when the inet service unloads the
TPCC.DLL
*/
void TermDeleteAll(void)
{
    EnterCriticalSection(&TermCriticalSection);

    for(int i=1; i<Term.iNumEntries; i++)
    {
        if (Term.pClientData[i].iNextFree == -1)
            delete Term.pClientData[i].pTxn;
    }

    Term.iFreeList = 0;
    Term.iNumEntries = 0;
    if ( Term.pClientData )
        free(Term.pClientData);
    Term.pClientData = NULL;
}
```

```
        LeaveCriticalSection(&TermCriticalSection);
    }

/* FUNCTION: TermAdd
*
* PURPOSE: This function assigns a terminal id which is used to identify a
client browser.
*
* RETURNS: int assigned terminal id
*/
int TermAdd(void)
{
    DWORD i;
    int iNewTerm, iTickCount;

    if (Term.iNumEntries == 0)
        return -1;

    EnterCriticalSection(&TermCriticalSection);
    if (Term.iFreeList != 0)
    {
        // position is available
        iNewTerm = Term.iFreeList;
        Term.iFreeList = Term.pClientData[iNewTerm].iNextFree;
        Term.pClientData[iNewTerm].iNextFree = -1; // indicates this
position is in use
    }
    else
    {
        // no open slots, so find the slot that hasn't been used in the
longest time and reuse it
        for(iNewTerm=1, i=1, iTickCount=0x7FFFFFFF; i<Reg.dwMaxConnections;
i++)
        {
            if (iTickCount > Term.pClientData[i].iTickCount)
            {
                iTickCount = Term.pClientData[i].iTickCount;
                iNewTerm = i;
            }
        }
        // if oldest term is less than one minute old, it probably means that
more connections
// are being attempted than were specified as "Max Connections" at
install. In this case,
// do not bump existing connection; instead, return error to
requestor.
        if ((GetTickCount() - iTickCount) < 60000)
        {
            LeaveCriticalSection(&TermCriticalSection);
            throw new CWEBCLNT_ERR( ERR_MAX_CONNECTIONS_EXCEEDED );
        }
    }

    Term.pClientData[iNewTerm].iTickCount = GetTickCount();
    Term.pClientData[iNewTerm].iSyncId = Term.iMasterSyncId++;
    Term.pClientData[iNewTerm].pTxn = NULL;

    LeaveCriticalSection(&TermCriticalSection);
    return iNewTerm;
}

/* FUNCTION: TermDelete
*
*/
```

Appendix A - Application Source Code

```
* PURPOSE:          This function makes a terminal entry in the Term array available for
reuse.
*
* ARGUMENTS:       int          id
                  Terminal id of client exiting
*
*/

void TermDelete(int id)
{
    if ( id > 0 && id < Term.iNumEntries )
    {
        delete Term.pClientData[id].pTxn;

        // put onto free list
        EnterCriticalSection(&TermCriticalSection);

        Term.pClientData[id].iNextFree = Term.iFreeList;
        Term.iFreeList = id;

        LeaveCriticalSection(&TermCriticalSection);
    }
}

/* FUNCTION: MakeErrorForm
*/

void ErrorForm(EXTENSION_CONTROL_BLOCK *pECB, int iType, int iErrorNum, int iTermId, int
iSyncId, char *szErrorText, char *szBuffer )
{
    wsprintf(szBuffer,
"<HTML><HEAD><TITLE>TPC-C Error</TITLE></HEAD><BODY>"
"<FORM ACTION=\"tpcc.dll\" METHOD=\"GET\">"
"<INPUT TYPE=\"hidden\" NAME=\"STATUSID\" VALUE=\"%d\">"
"<INPUT TYPE=\"hidden\" NAME=\"ERROR\" VALUE=\"%d\">"
"<INPUT TYPE=\"hidden\" NAME=\"FORMID\" VALUE=\"%d\">"
"<INPUT TYPE=\"hidden\" NAME=\"TERMINID\" VALUE=\"%d\">"
"<INPUT TYPE=\"hidden\" NAME=\"SYNCID\" VALUE=\"%d\">"
"<BOLD>An Error Occurred</BOLD><BR><BR>"
"%s"
"<BR><BR><HR>"
"<INPUT TYPE=\"submit\" NAME=\"CMD\" VALUE=\"..NewOrder..\">"
"<INPUT TYPE=\"submit\" NAME=\"CMD\" VALUE=\"..Payment..\">"
"<INPUT TYPE=\"submit\" NAME=\"CMD\" VALUE=\"..Delivery..\">"
"<INPUT TYPE=\"submit\" NAME=\"CMD\" VALUE=\"..Order-Status..\">"
"<INPUT TYPE=\"submit\" NAME=\"CMD\" VALUE=\"..Stock-Level..\">"
"<INPUT TYPE=\"submit\" NAME=\"CMD\" VALUE=\"..Exit..\">"
"</FORM></BODY></HTML>"
, iType, iErrorNum, MAIN_MENU_FORM, iTermId, iSyncId, szErrorText );
}

/* FUNCTION: MakeMainMenuForm
*/

void MakeMainMenuForm(int iTermId, int iSyncId, char *szForm)
{
    wsprintf(szForm,
"<HTML><HEAD><TITLE>TPC-C Main Menu</TITLE></HEAD><BODY>"
"Select Desired Transaction.<BR><HR>"
"<FORM ACTION=\"tpcc.dll\" METHOD=\"GET\">"
"<INPUT TYPE=\"hidden\" NAME=\"STATUSID\" VALUE=\"%0\">"
"<INPUT TYPE=\"hidden\" NAME=\"ERROR\" VALUE=\"%0\">"

```

```
"<INPUT TYPE=\"hidden\" NAME=\"FORMID\" VALUE=\"%d\">"
"<INPUT TYPE=\"hidden\" NAME=\"TERMINID\" VALUE=\"%d\">"
"<INPUT TYPE=\"hidden\" NAME=\"SYNCID\" VALUE=\"%d\">"
"<INPUT TYPE=\"submit\" NAME=\"CMD\" VALUE=\"..NewOrder..\">"
"<INPUT TYPE=\"submit\" NAME=\"CMD\" VALUE=\"..Payment..\">"
"<INPUT TYPE=\"submit\" NAME=\"CMD\" VALUE=\"..Delivery..\">"
"<INPUT TYPE=\"submit\" NAME=\"CMD\" VALUE=\"..Order-Status..\">"
"<INPUT TYPE=\"submit\" NAME=\"CMD\" VALUE=\"..Stock-Level..\">"
"<INPUT TYPE=\"submit\" NAME=\"CMD\" VALUE=\"..Exit..\">"
"</FORM></BODY></HTML>"
, MAIN_MENU_FORM, iTermId, iSyncId);
}

/* FUNCTION: MakeStockLevelForm
*
* PURPOSE:          This function constructs the Stock Level HTML page.
*
* COMMENTS:        The internal client buffer is created when the terminal id is
assigned and should not
                    be freed except when the client terminal id is no
longer needed.
*/

void MakeStockLevelForm(int iTermId, STOCK_LEVEL_DATA *pStockLevelData, BOOL bInput, char
*szForm)
{
    int    c;

    c = wsprintf(szForm,
"<HTML><HEAD><TITLE>TPC-C Stock Level</TITLE></HEAD><FORM
ACTION=\"tpcc.dll\" METHOD=\"GET\">"
"<INPUT TYPE=\"hidden\" NAME=\"STATUSID\" VALUE=\"%0\">"
"<INPUT TYPE=\"hidden\" NAME=\"ERROR\" VALUE=\"%0\">"
"<INPUT TYPE=\"hidden\" NAME=\"FORMID\" VALUE=\"%d\">"
"<INPUT TYPE=\"hidden\" NAME=\"TERMINID\" VALUE=\"%d\">"
"<INPUT TYPE=\"hidden\" NAME=\"SYNCID\" VALUE=\"%d\">"
"<PRE><font face=\"Courier\">
Level<BR>"
"Warehouse: %4.4d District: %2.2d<BR> <BR>",
STOCK_LEVEL_FORM, iTermId, Term.pClientData[iTermId].iSyncId,
Term.pClientData[iTermId].w_id, Term.pClientData[iTermId].d_id);

    if ( bInput )
    {
        strcpy(szForm+c,
"Stock Level Threshold: <INPUT NAME=\"TT*\" SIZE=2><BR>"
"low stock:    </font><BR> <BR> <BR> <BR> <BR> <BR> <BR>"
" <BR> <BR> <BR> <BR> <BR> <BR> <BR></PRE><HR>"
"<INPUT TYPE=\"submit\" NAME=\"CMD\" VALUE=\"Process\">"
"<INPUT TYPE=\"submit\" NAME=\"CMD\" VALUE=\"Menu\">"
"</FORM></HTML>" );
    }
    else
    {
        wsprintf(szForm+c,
"Stock Level Threshold: %2.2d<BR> <BR>"
"low stock: %3.3d</font> <BR> <BR> <BR> <BR> <BR> <BR> <BR>"
" <BR> <BR> <BR> <BR> <BR> <BR> <BR></PRE><HR>"
"<INPUT TYPE=\"submit\" NAME=\"CMD\">"
VALUE=\"..NewOrder..\">"

```

Appendix A - Application Source Code

```

        {
            c += sprintf(szForm+c,
                "%#Disc: %5.2f
Order Number: %8.8d Number
of Lines: %2.2d      W_tax: %5.2f  D_tax: %5.2f <BR> <BR>"
                " Supp_W Item_Id Item Name
Qty Stock B/G Price  Amount<BR>",
                100.0*pNewOrderData->c_discount,
                pNewOrderData->o_id,
                pNewOrderData->o_ol_cnt,
                100.0 * pNewOrderData->w_tax,
                100.0 * pNewOrderData->d_tax);

            for(i=0; i<pNewOrderData->o_ol_cnt; i++)
            {
                c += sprintf(szForm+c, " %4.4d %6.6d %2.2s
%2.2d %3.3d %1.1s  $%6.2f  $%7.2f <BR>",
                pNewOrderData->OL[i].ol_supply_w_id,
                pNewOrderData->OL[i].ol_i_id,
                pNewOrderData->OL[i].ol_i_name,
                pNewOrderData->OL[i].ol_quantity,
                pNewOrderData->OL[i].ol_stock,
                pNewOrderData->OL[i].ol_brand_generic,
                pNewOrderData->OL[i].ol_i_price,
                pNewOrderData->OL[i].ol_amount );
            }
        }
        else
        {
            c += wsprintf(szForm+c,
                "%Disc:<BR>
Order Number: %8.8d Number of Lines:
W_tax:      D_tax:<BR> <BR>"
                " Supp_W Item_Id Item Name      Qty
Stock B/G Price  Amount<BR>"
                , pNewOrderData->o_id);

            i = 0;

            strncpy( szForm+c, szBR, (15-i)*5 );
            c += (15-i)*5;

            if ( bValid )
                c += sprintf(szForm+c, "Execution Status: Transaction
committed.      Total:  $%8.2f  ",
                pNewOrderData->total_amount);
            else
                c += wsprintf(szForm+c, "Execution Status: Item number is
not valid.      Total:");

            strcpy(szForm+c,
                " <BR></Font></PRE><HR>"
                "<INPUT TYPE=\"submit\" NAME=\"CMD\""
                " VALUE=\"..NewOrder..\">"
                "<INPUT TYPE=\"submit\" NAME=\"CMD\""
                " VALUE=\"..Payment..\">"
                "<INPUT TYPE=\"submit\" NAME=\"CMD\""
                " VALUE=\"..Delivery..\">"
                "<INPUT TYPE=\"submit\" NAME=\"CMD\" VALUE=\"..Order-
Status..\">"

```

```

Level..\">"
                "<INPUT TYPE=\"submit\" NAME=\"CMD\" VALUE=\"..Stock-
Level..\">"
                "<INPUT TYPE=\"submit\" NAME=\"CMD\" VALUE=\"..Exit..\">"
                "</FORM></HTML>"
            );
        }
    }

    /* FUNCTION: MakePaymentForm
    *
    * COMMENTS:      The internal client buffer is created when the terminal id is
    assigned and should not
    *
    *                  be freed except when the client terminal id is no
    longer needed.
    */

void MakePaymentForm(int iTermId, PAYMENT_DATA *pPaymentData, BOOL bInput, char *szForm)
{
    int c;

    c = wsprintf(szForm,
        "<HTML><HEAD><TITLE>TPC-C Payment</TITLE></HEAD><BODY>"
        "<FORM ACTION=\"tpcc.dll\" METHOD=\"GET\">"
        "<INPUT TYPE=\"hidden\" NAME=\"STATUSID\" VALUE=\"0\">"
        "<INPUT TYPE=\"hidden\" NAME=\"ERROR\" VALUE=\"0\">"
        "<INPUT TYPE=\"hidden\" NAME=\"FORMID\" VALUE=\"%d\">"
        "<INPUT TYPE=\"hidden\" NAME=\"TERMIN\" VALUE=\"%d\">"
        "<INPUT TYPE=\"hidden\" NAME=\"SYNCID\" VALUE=\"%d\">"
        "<PRE><font face=\"Courier\">"

        Payment<BR>"
        "Date: "
        , PAYMENT_FORM, iTermId, Term.pClientData[iTermId].iSyncId);

    if ( !bInput )
    {
        c += wsprintf(szForm+c, "%2.2d-%2.2d-%4.4d %2.2d:%2.2d:%2.2d",
            pPaymentData->h_date.day,
            pPaymentData->h_date.month,
            pPaymentData->h_date.year,
            pPaymentData->h_date.hour,
            pPaymentData->h_date.minute,
            pPaymentData->h_date.second);
    }

    if ( bInput )
    {
        c += wsprintf(szForm+c,
            "<BR> <BR>Warehouse: %4.4d"
            " District: <INPUT NAME=\"DID\"\"
            SIZE=1><BR> <BR> <BR> <BR> <BR>"
            "Customer: <INPUT NAME=\"CID\"\" SIZE=4>"
            "Cust-Warehouse: <INPUT NAME=\"CWI\"\" SIZE=4> "
            "Cust-District: <INPUT NAME=\"CDI\"\" SIZE=1><BR>"
            "Name: <INPUT NAME=\"CLT\"\" SIZE=16>"

            Since:<BR>"
            "
            Credit:<BR>"
            "
            Disc:<BR>"
            "
            Phone:<BR> <BR>"
            "Amount Paid: $<INPUT NAME=\"HAM\"\" SIZE=7>"

            New Cust-Balance:<BR>"

```

Appendix A - Application Source Code

```
(pDeliveryData->exec_status_code == eOK) ? "Delivery has
been queued." : "Delivery Post Failed "
);
}
}

/* FUNCTION: ProcessNewOrderForm
 *
 * PURPOSE: This function gets and validates the input data from the new order
 form
 *
 * filling in the required input variables. it then calls the
 SQLNewOrder
 *
 * transaction, constructs the output form and writes it back
 to client
 *
 * browser.
 */

void ProcessNewOrderForm(EXTENSION_CONTROL_BLOCK *pECB, int iTermId, char *szBuffer)
{
    PNEW_ORDER_DATA pNewOrder;

    pNewOrder = Term.pClientData[iTermId].pTxn->BuffAddr_NewOrder();

    ZeroMemory(pNewOrder, sizeof(NEW_ORDER_DATA));
    pNewOrder->w_id = Term.pClientData[iTermId].w_id;
    GetNewOrderData(pECB->lpszQueryString, pNewOrder);

    Term.pClientData[iTermId].pTxn->NewOrder();

    pNewOrder = Term.pClientData[iTermId].pTxn->BuffAddr_NewOrder();
    MakeNewOrderForm(iTermId, pNewOrder, OUTPUT_FORM, szBuffer );
}

/* FUNCTION: void ProcessPaymentForm
 *
 * PURPOSE: This function gets and validates the input data from the payment form
 *
 * filling in the required input variables. It then calls the
 SQLPayment
 *
 * transaction, constructs the output form and writes it back
 to client
 *
 * browser.
 *
 * ARGUMENTS: EXTENSION_CONTROL_BLOCK *pECB passed in structure pointer
 from inetsrv.
 *
 * int
 * iTermId client browser terminal id
 */

void ProcessPaymentForm(EXTENSION_CONTROL_BLOCK *pECB, int iTermId, char *szBuffer)
{
    PPAYMENT_DATA pPayment;

    pPayment = Term.pClientData[iTermId].pTxn->BuffAddr_Payment();
    ZeroMemory(pPayment, sizeof(PAYMENT_DATA));
    pPayment->w_id = Term.pClientData[iTermId].w_id;
    GetPaymentData(pECB->lpszQueryString, pPayment);

    Term.pClientData[iTermId].pTxn->Payment();

    pPayment = Term.pClientData[iTermId].pTxn->BuffAddr_Payment();
    MakePaymentForm(iTermId, pPayment, OUTPUT_FORM, szBuffer);
}
```

```
/* FUNCTION: ProcessOrderStatusForm
 *
 * PURPOSE: This function gets and validates the input data from the Order Status
 form filling in the required input variables. It then calls
 the
 *
 * SQLOrderStatus transaction, constructs the output form and
 writes it
 *
 * back to client browser.
 *
 * ARGUMENTS: EXTENSION_CONTROL_BLOCK *pECB passed in structure pointer
 from inetsrv.
 *
 * int
 * iTermId client browser terminal id
 */

void ProcessOrderStatusForm(EXTENSION_CONTROL_BLOCK *pECB, int iTermId, char *szBuffer)
{
    PORDER_STATUS_DATA pOrderStatus;

    pOrderStatus = Term.pClientData[iTermId].pTxn->BuffAddr_OrderStatus();
    ZeroMemory(pOrderStatus, sizeof(ORDER_STATUS_DATA));
    pOrderStatus->w_id = Term.pClientData[iTermId].w_id;
    GetOrderStatusData(pECB->lpszQueryString, pOrderStatus);

    Term.pClientData[iTermId].pTxn->OrderStatus();

    pOrderStatus = Term.pClientData[iTermId].pTxn->BuffAddr_OrderStatus();
    MakeOrderStatusForm(iTermId, pOrderStatus, OUTPUT_FORM, szBuffer);
}

/* FUNCTION: ProcessDeliveryForm
 *
 * PURPOSE: This function gets and validates the input data from the delivery
 form
 *
 * filling in the required input variables. It then calls the
 PostDeliveryInfo
 *
 * Api, The client is then informed that the transaction has
 been posted.
 *
 * ARGUMENTS: EXTENSION_CONTROL_BLOCK *pECB passed in structure pointer
 from inetsrv.
 *
 * int
 * iTermId client browser terminal id
 */

void ProcessDeliveryForm(EXTENSION_CONTROL_BLOCK *pECB, int iTermId, char *szBuffer)
{
    char *ptr = pECB->lpszQueryString;

    PDELIVERY_DATA pDelivery;

    pDelivery = Term.pClientData[iTermId].pTxn->BuffAddr_Delivery();
    ZeroMemory(pDelivery, sizeof(DELIVERY_DATA));
    pDelivery->w_id = Term.pClientData[iTermId].w_id;

    pDelivery->o_carrier_id = GetIntKeyValue(&ptr, "OCD*",
ERR_DELIVERY_MISSING_OCD_KEY, ERR_DELIVERY_CARRIER_INVALID);
    if ( pDelivery->o_carrier_id > 10 || pDelivery->o_carrier_id < 1 )
        throw new CWBCLNT_ERR( ERR_DELIVERY_CARRIER_ID_RANGE );
}
```

Appendix A - Application Source Code

```
if (dwNumDeliveryThreads)
{
    //post delivery info
    if ( PostDeliveryInfo(pDelivery->w_id, pDelivery->o_carrier_id) )
        pDelivery->exec_status_code = eDeliveryFailed;
    else
        pDelivery->exec_status_code = eOK;
}
else // delivery is done synchronously if no delivery threads configured
    Term.pClientData[iTermId].pTxn->Delivery();

pDelivery = Term.pClientData[iTermId].pTxn->BuffAddr_Delivery();
MakeDeliveryForm(iTermId, pDelivery, OUTPUT_FORM, szBuffer);
}

/* FUNCTION: ProcessStockLevelForm
 *
 * PURPOSE:      This function gets and validates the input data from the Stock Level
 *               form filling in the required input variables. It then calls
 *               the SQLStockLevel transaction, constructs the output form and
 *               writes it back to client browser.
 *
 * ARGUMENTS:    EXTENSION_CONTROL_BLOCK *pECB    passed in structure pointer
 *               from inetsrv.
 *               int iTermId    client browser terminal id
 */

void ProcessStockLevelForm(EXTENSION_CONTROL_BLOCK *pECB, int iTermId, char *szBuffer)
{
    char *ptr = pECB->lpszQueryString;

    PSTOCK_LEVEL_DATA pStockLevel;

    pStockLevel = Term.pClientData[iTermId].pTxn->BuffAddr_StockLevel();
    ZeroMemory( pStockLevel, sizeof(STOCK_LEVEL_DATA) );

    pStockLevel->w_id = Term.pClientData[iTermId].w_id;
    pStockLevel->d_id = Term.pClientData[iTermId].d_id;

    pStockLevel->threshold = GetIntKeyValue(&ptr, "TT",
ERR_STOCKLEVEL_MISSING_THRESHOLD_KEY, ERR_STOCKLEVEL_THRESHOLD_INVALID);
    if ( pStockLevel->threshold >= 100 || pStockLevel->threshold < 0 )
        throw new CWBCLNT_ERR( ERR_STOCKLEVEL_THRESHOLD_RANGE );

    Term.pClientData[iTermId].pTxn->StockLevel();

    pStockLevel = Term.pClientData[iTermId].pTxn->BuffAddr_StockLevel();
    MakeStockLevelForm(iTermId, pStockLevel, OUTPUT_FORM, szBuffer);
}

/* FUNCTION: GetNewOrderData
 *
 * PURPOSE:      This function extracts and validates the new order form data from an
 *               http command string.
 *
 * ARGUMENTS:    LPSTR lpszQueryString    client
 *               browser http command string
 *               NEW_ORDER_DATA *pNewOrderData
 *               pointer to new order data structure
 */
```

```
*
*/

void GetNewOrderData(LPSTR lpszQueryString, NEW_ORDER_DATA *pNewOrderData)
{
    char szTmp[26];
    int i;
    short items;
    int ol_i_id, ol_quantity;
    char *ptr = lpszQueryString;

    static char szSP[MAX_OL_NEW_ORDER_ITEMS][6] =
    { "SP00*", "SP01*", "SP02*", "SP03*", "SP04*",
      "SP05*", "SP06*", "SP07*", "SP08*", "SP09*",
      "SP10*", "SP11*", "SP12*", "SP13*", "SP14*" };
    static char szIID[MAX_OL_NEW_ORDER_ITEMS][7] =
    { "IID00*", "IID01*", "IID02*", "IID03*", "IID04*",
      "IID05*", "IID06*", "IID07*", "IID08*", "IID09*",
      "IID10*", "IID11*", "IID12*", "IID13*", "IID14*" };
    static char szQty[MAX_OL_NEW_ORDER_ITEMS][7] =
    { "Qty00*", "Qty01*", "Qty02*", "Qty03*", "Qty04*",
      "Qty05*", "Qty06*", "Qty07*", "Qty08*", "Qty09*",
      "Qty10*", "Qty11*", "Qty12*", "Qty13*", "Qty14*" };

    pNewOrderData->d_id = GetIntKeyValue(&ptr, "DID*",
ERR_NEWORDER_FORM_MISSING_DID, ERR_NEWORDER_DISTRICT_INVALID);
    pNewOrderData->c_id = GetIntKeyValue(&ptr, "CID*", ERR_NEWORDER_CUSTOMER_KEY,
ERR_NEWORDER_CUSTOMER_INVALID);

    for(i=0, items=0; i<MAX_OL_NEW_ORDER_ITEMS; i++)
    {
        GetKeyValue(&ptr, szSP[i], szTmp, sizeof(szTmp),
ERR_NEWORDER_MISSING_SUPPW_KEY);
        if ( szTmp[0] )
        {
            if ( !IsNumeric(szTmp) )
                throw new CWBCLNT_ERR(
ERR_NEWORDER_SUPPW_INVALID );
            pNewOrderData->OL[items].ol_supply_w_id =
(short)atoi(szTmp);

            ol_i_id = pNewOrderData->OL[items].ol_i_id =
                GetIntKeyValue(&ptr, szIID[i],
ERR_NEWORDER_MISSING_IID_KEY, ERR_NEWORDER_ITEMID_INVALID);
            if ( ol_i_id > 999999 || ol_i_id < 1 )
                throw new CWBCLNT_ERR( ERR_NEWORDER_ITEMID_RANGE );

            ol_quantity = pNewOrderData->OL[items].ol_quantity =
                GetIntKeyValue(&ptr, szQty[i],
ERR_NEWORDER_MISSING_QTY_KEY, ERR_NEWORDER_QTY_INVALID);
            if ( ol_quantity > 99 || ol_quantity < 1 )
                throw new CWBCLNT_ERR( ERR_NEWORDER_QTY_RANGE );

            items++;
        }
        else
        {
            // nothing entered for supply warehouse, so item id and qty
            must also be blank
            GetKeyValue(&ptr, szIID[i], szTmp, sizeof(szTmp),
ERR_NEWORDER_MISSING_IID_KEY);
            if ( szTmp[0] )

```

Appendix A - Application Source Code

```
throw new CWBCLNT_ERR(
ERR_NEWORDER_ITEMID_WITHOUT_SUPPW );

    GetKeyValue(&ptr, szQty[i], szTmp, sizeof(szTmp),
ERR_NEWORDER_MISSING_QTY_KEY);
    if ( szTmp[0] )
        throw new CWBCLNT_ERR(
ERR_NEWORDER_QTY_WITHOUT_SUPPW );
    }
    if ( items == 0 )
        throw new CWBCLNT_ERR( ERR_NEWORDER_NOITEMS_ENTERED );
}

pNewOrderData->o_ol_cnt = items;
}
/* FUNCTION: GetPaymentData
 *
 * PURPOSE:      This function extracts and validates the payment form data from an
http command string.
 *
 * ARGUMENTS:    LPSTR          lpszQueryString          client
browser http command string
 *
 *               PAYMENT_DATA    *pPaymentData
 *               pointer to payment data structure
 */
void GetPaymentData(LPSTR lpszQueryString, PAYMENT_DATA *pPaymentData)
{
    char    szTmp[26];
    char    *ptr = lpszQueryString;
    BOOL    bCustIdBlank;

    pPaymentData->d_id = GetIntKeyValue(&ptr, "DID*", ERR_PAYMENT_MISSING_DID_KEY,
ERR_PAYMENT_DISTRICT_INVALID);

    GetKeyValue(&ptr, "CID*", szTmp, sizeof(szTmp), ERR_PAYMENT_MISSING_CID_KEY);
    if ( szTmp[0] == 0 )
    {
        bCustIdBlank = TRUE;
        pPaymentData->c_id = 0;
    }
    else
    {
        // parse customer id and verify that last name was NOT entered
        bCustIdBlank = FALSE;
        if ( !IsNumeric(szTmp) )
            throw new CWBCLNT_ERR( ERR_PAYMENT_CUSTOMER_INVALID );
        pPaymentData->c_id = atoi(szTmp);
    }

    pPaymentData->c_w_id = GetIntKeyValue(&ptr, "CWI*",
ERR_PAYMENT_MISSING_CWI_KEY, ERR_PAYMENT_CWI_INVALID);
    pPaymentData->c_d_id = GetIntKeyValue(&ptr, "CDI*",
ERR_PAYMENT_MISSING_CDI_KEY, ERR_PAYMENT_CDI_INVALID);

    if ( bCustIdBlank )
    {
        // customer id is blank, so last name must be entered
        GetKeyValue(&ptr, "CLT*", szTmp, sizeof(szTmp),
ERR_PAYMENT_MISSING_CLT_KEY);
        if ( szTmp[0] == 0 )
            throw new CWBCLNT_ERR( ERR_PAYMENT_MISSING_CID_CLT );
        _strupr( szTmp );
    }
}
```

```
if ( strlen(pPaymentData->c_last) > LAST_NAME_LEN )
    throw new CWBCLNT_ERR( ERR_PAYMENT_LAST_NAME_TO_LONG );
strcpy(pPaymentData->c_last, szTmp);
}
else
{
    // parse customer id and verify that last name was NOT entered
    GetKeyValue(&ptr, "CLT*", szTmp, sizeof(szTmp),
ERR_PAYMENT_MISSING_CLT_KEY);
    if ( szTmp[0] != 0 )
        throw new CWBCLNT_ERR( ERR_PAYMENT_CID_AND_CLT );
}

    GetKeyValue(&ptr, "HAM*", szTmp, sizeof(szTmp), ERR_PAYMENT_MISSING_HAM_KEY);
    if (!IsDecimal(szTmp))
        throw new CWBCLNT_ERR( ERR_PAYMENT_HAM_INVALID );
    pPaymentData->h_amount = atof(szTmp);
    if ( pPaymentData->h_amount >= 10000.00 || pPaymentData->h_amount < 0 )
        throw new CWBCLNT_ERR( ERR_PAYMENT_HAM_RANGE );
}

/* FUNCTION: GetOrderStatusData
 *
 * PURPOSE:      This function extracts and validates the payment form data from an
http command string.
 *
 * ARGUMENTS:    LPSTR          lpszQueryString          client
browser http command string
 *
 *               ORDER_STATUS_DATA *pOrderStatusData
 */
void GetOrderStatusData(LPSTR lpszQueryString, ORDER_STATUS_DATA *pOrderStatusData)
{
    char    szTmp[26];
    char    *ptr = lpszQueryString;

    pOrderStatusData->d_id = GetIntKeyValue(&ptr, "DID*",
ERR_ORDERSTATUS_MISSING_DID_KEY, ERR_ORDERSTATUS_DID_INVALID);

    GetKeyValue(&ptr, "CID*", szTmp, sizeof(szTmp),
ERR_ORDERSTATUS_MISSING_CID_KEY);
    if ( szTmp[0] == 0 )
    {
        // customer id is blank, so last name must be entered
        pOrderStatusData->c_id = 0;
        GetKeyValue(&ptr, "CLT*", szTmp, sizeof(szTmp),
ERR_ORDERSTATUS_MISSING_CLT_KEY);
        if ( szTmp[0] == 0 )
            throw new CWBCLNT_ERR( ERR_ORDERSTATUS_MISSING_CID_CLT );
        _strupr( szTmp );
        if ( strlen(pOrderStatusData->c_last) > LAST_NAME_LEN )
            throw new CWBCLNT_ERR( ERR_ORDERSTATUS_CLT_RANGE );
        strcpy(pOrderStatusData->c_last, szTmp);
    }
    else
    {
        // parse customer id and verify that last name was NOT entered
        if ( !IsNumeric(szTmp) )
            throw new CWBCLNT_ERR( ERR_ORDERSTATUS_CID_INVALID );
        pOrderStatusData->c_id = atoi(szTmp);
        GetKeyValue(&ptr, "CLT*", szTmp, sizeof(szTmp),
ERR_ORDERSTATUS_MISSING_CLT_KEY);
        if ( szTmp[0] != 0 )
            throw new CWBCLNT_ERR( ERR_ORDERSTATUS_CID_AND_CLT );
    }
}

/* FUNCTION: BOOL IsNumeric(char *ptr)
```

Appendix A - Application Source Code

```
*
* PURPOSE:      This function determines if a string is numeric. It fails if any
characters other than numeric and null terminator are present.
*
* ARGUMENTS:    char          *ptr      pointer to string to check.
*
* RETURNS:      BOOL          FALSE    if string is not all numeric
              TRUE          if string contains
only numeric characters i.e. '0' - '9'
*/

BOOL IsNumeric(char *ptr)
{
    if ( *ptr == 0 )
        return FALSE;

    while( *ptr && isdigit(*ptr) )
        ptr++;
    return ( !*ptr );
}

/* FUNCTION: BOOL IsDecimal(char *ptr)
*
* PURPOSE:      This function determines if a string is a non-negative decimal value.
*               It fails if any characters other than a series of numbers followed by
*               a decimal point, another series of numbers, and a null
terminator are present.
*
* ARGUMENTS:    char          *ptr      pointer to string to check.
*
* RETURNS:      BOOL          FALSE    if string is not a valid non-negative
decimal value
              TRUE          if string is OK
*/

BOOL IsDecimal(char *ptr)
{
    char *dotptr;
    BOOL bValid;

    if ( *ptr == 0 )
        return FALSE;

    // find decimal point
    dotptr = strchr( ptr, '.' );
    if (dotptr == NULL)
        // no decimal point, so just check for numeric
        return IsNumeric(ptr);
    *dotptr = 0; // temporarily replace decimal with a terminator

    if ( *ptr != 0 )
        bValid = IsNumeric(ptr);
    // string starts with decimal point
    else if (*(dotptr+1) == 0)
        return FALSE; // nothing but a decimal point is bad
    else
        bValid = TRUE;

    if (*(dotptr+1) != 0)
        // check text after decimal point
        bValid &= IsNumeric(dotptr+1);
}
```

```
*dotptr = '.'; // replace decimal point
return bValid;
}
```

isapi_dll/src/resource.h

```
{{NO_DEPENDENCIES}}
// Microsoft Developer Studio generated include file.
// Used by tpcc.rc
//
#define IDD_DIALOG1                101

// Next default values for new objects
//
#ifdef APSTUDIO_INVOKED
#ifdef APSTUDIO_READONLY_SYMBOLS
#define _APS_NEXT_RESOURCE_VALUE    102
#define _APS_NEXT_COMMAND_VALUE    40001
#define _APS_NEXT_CONTROL_VALUE    1000
#define _APS_NEXT_SYMED_VALUE      101
#endif
#endif
```

common/src/ReadRegistry.cpp

```
/* FILE:          READREGISTRY.CPP
*
*               Microsoft TPC-C Kit Ver. 4.20.000
*               Copyright Microsoft, 1999
*
*               All Rights Reserved
*
*               not yet audited
*
* PURPOSE:      Implementation for TPC-C Tuxedo class.
* Contact:      Charles Levine (clevine@microsoft.com)
*
* Change history:
* 4.20.000 - first version
*/

/* FUNCTION: ReadTPCCRegistrySettings
*
* PURPOSE:      This function reads the NT registry for startup parameters. There
parameters are
                under the TPCC key.
*
* RETURNS      FALSE = no errors
              TRUE  = error reading registry
*/
BOOL ReadTPCCRegistrySettings( TPCCREGISTRYDATA *pReg )
{
    HKEY hKey;
    DWORD size;
    DWORD type;
    DWORD dwTmp;
```

Appendix A - Application Source Code

```
char    szTmp[256];

if ( RegOpenKeyEx(HKEY_LOCAL_MACHINE, "SOFTWARE\\Microsoft\\TPCC", 0, KEY_READ,
&hKey) != ERROR_SUCCESS )
    return TRUE;

// determine database protocol to use; may be either ODBC or DBLIB
pReg->eDB_Protocol = Unspecified;
size = sizeof(szTmp);
if ( RegQueryValueEx(hKey, "DB_Protocol", 0, &type, (BYTE *)&szTmp, &size) ==
ERROR_SUCCESS )
{
    if ( !strcmp(szTmp, szDBNames[ODBC]) )
        pReg->eDB_Protocol = ODBC;
    else if ( !strcmp(szTmp, szDBNames[DBLIB]) )
        pReg->eDB_Protocol = DBLIB;
}

pReg->eTxnMon = None;
// determine txn monitor to use; may be either TUXEDO, or blank
size = sizeof(szTmp);
if ( RegQueryValueEx(hKey, "TxnMonitor", 0, &type, (BYTE *)&szTmp, &size) ==
ERROR_SUCCESS )
{
    if ( !strcmp(szTmp, szTxnMonNames[TUXEDO]) )
        pReg->eTxnMon = TUXEDO;
    else if ( !strcmp(szTmp, szTxnMonNames[ENCINA]) )
        pReg->eTxnMon = ENCINA;
    else if ( !strcmp(szTmp, szTxnMonNames[COM]) )
        pReg->eTxnMon = COM;
}

pReg->bCOM_SinglePool = FALSE;
size = sizeof(szTmp);
if ( RegQueryValueEx(hKey, "COM_SinglePool", 0, &type, (BYTE *)&szTmp, &size)
== ERROR_SUCCESS )
{
    if ( !strcmp(szTmp, "YES") )
        pReg->bCOM_SinglePool = TRUE;
}

pReg->dwMaxConnections = 0;
size = sizeof(dwTmp);
if ( ( RegQueryValueEx(hKey, "MaxConnections", 0, &type, (LPBYTE)&dwTmp, &size)
== ERROR_SUCCESS )
    && (type == REG_DWORD) )
    pReg->dwMaxConnections = dwTmp;

pReg->dwMaxPendingDeliveries = 0;
size = sizeof(dwTmp);
if ( ( RegQueryValueEx(hKey, "MaxPendingDeliveries", 0, &type, (LPBYTE)&dwTmp,
&size) == ERROR_SUCCESS )
    && (type == REG_DWORD) )
    pReg->dwMaxPendingDeliveries = dwTmp;

pReg->dwNumberOfDeliveryThreads = 0;
size = sizeof(dwTmp);
if ( ( RegQueryValueEx(hKey, "NumberOfDeliveryThreads", 0, &type,
(LPBYTE)&dwTmp, &size) == ERROR_SUCCESS )
    && (type == REG_DWORD) )
    pReg->dwNumberOfDeliveryThreads = dwTmp;

size = sizeof( pReg->szPath );
```

```
if ( RegQueryValueEx(hKey, "Path", 0, &type, (BYTE *)&pReg->szPath, &size) !=
ERROR_SUCCESS )
    pReg->szPath[0] = 0;

size = sizeof( pReg->szDbServer );
if ( RegQueryValueEx(hKey, "DbServer", 0, &type, (BYTE *)&pReg->szDbServer,
&size) != ERROR_SUCCESS )
    pReg->szDbServer[0] = 0;

size = sizeof( pReg->szDbName );
if ( RegQueryValueEx(hKey, "DbName", 0, &type, (BYTE *)&pReg->szDbName, &size)
!= ERROR_SUCCESS )
    pReg->szDbName[0] = 0;

size = sizeof( pReg->szDbUser );
if ( RegQueryValueEx(hKey, "DbUser", 0, &type, (BYTE *)&pReg->szDbUser, &size)
!= ERROR_SUCCESS )
    pReg->szDbUser[0] = 0;

size = sizeof( pReg->szDbPassword );
if ( RegQueryValueEx(hKey, "DbPassword", 0, &type, (BYTE *)&pReg->szDbPassword,
&size) != ERROR_SUCCESS )
    pReg->szDbPassword[0] = 0;

RegCloseKey(hKey);

return FALSE;
}
```

common/src/ReadRegistry.h

```
/* FILE: ReadRegistry.h
 * Microsoft TPC-C Kit Ver. 4.20.000
 * Copyright Microsoft, 1999
 * All Rights Reserved
 * not audited
 * PURPOSE: Header for registry related code.
 * Change history:
 * 4.20.000 - first version
 */
```

```
enum DBPROTOCOL { Unspecified, ODBC, DBLIB };
const char *szDBNames[] = { "Unspecified", "ODBC", "DBLIB" };

enum TXNMON { None, TUXEDO, ENCINA, COM };
const char *szTxnMonNames[] = { "NONE", "TUXEDO", "ENCINA", "COM" };

//This structure defines the data necessary to keep distinct for each terminal or client
connection.
typedef struct _TPCCREGISTRYDATA
{
    enum DBPROTOCOL eDB_Protocol;
    enum TXNMON eTxnMon;
    BOOL bCOM_SinglePool;
    DWORD dwMaxConnections;
    DWORD dwMaxPendingDeliveries;
```

Appendix A - Application Source Code

```
    DWORD dwNumberOfDeliveryThreads;
    char szPath[128];
    char szDbServer[32];
    char szDbName[32];
    char szDbUser[32];
    char szDbPassword[32];
} TPCCREGISTRYDATA, *PTPCCREGISTRYDATA;

BOOL ReadTPCCRegistrySettings( TPCCREGISTRYDATA *pReg );
```

common/src/error.h

```
/*      FILE:                ERROR.H
 *
 *      Microsoft TPC-C Kit Ver. 4.20.000
 *      Copyright Microsoft, 1999
 *
 *      All Rights Reserved
 *
 *      Version 4.10.000 audited by Richard Gimarc,
 *      Performance Metrics, 3/17/99
 *
 *      PURPOSE:  Header file for error exception classes.
 *
 *      Change history:
 *      4.20.000 - updated rev number to match kit
 *      4.21.000 - fixed bug: ~CBaseErr needed to be declared virtual
 */

#pragma once

#ifndef _INC_STRING
#include <string.h>
#endif

const int m_szMsg_size = 512;
const int m_szApp_size = 64;
const int m_szLoc_size = 64;

//error message structure used in ErrorText routines
typedef struct _SERRORMSG
{
    int                iError;                //error id of
message              char    szMsg[256];    //message to sent to browser
} SERRORMSG;

#define ERR_FATAL_LEVEL                1
#define ERR_WARNING_LEVEL              2
#define ERR_INFORMATION_LEVEL         3

#define ERR_TYPE_LOGIC                 -1      //logic error in program; internal error
#define ERR_SUCCESS                     0      //success (a non-error error)
#define ERR_BAD_ITEM_ID                 1      //expected abort record in txnRecord
#define ERR_TYPE_DELIVERY_POST         2      //expected delivery post failed
```

```
#define ERR_TYPE_WEBDLL                 3      //tpcc web generated error
#define ERR_TYPE_SQL                     4      //sql server generated error
#define ERR_TYPE_DBLIB                   5      //dblib generated error
#define ERR_TYPE_ODBC                     6      //odbc generated error
#define ERR_TYPE_SOCKET                   7      //error on communication socket client rte only
#define ERR_TYPE_DEADLOCK                 8      //dblib and odbc only deadlock condition
#define ERR_TYPE_COM                       9      //error from COM call
#define ERR_TYPE_TUXEDO                   10     //tuxedo error
#define ERR_TYPE_OS                       11     //operating system error
#define ERR_TYPE_MEMORY                   12     //memory allocation error
#define ERR_TYPE_TPCC_ODBC                13     //error from tpcc odbc txn module
#define ERR_TYPE_TPCC_DBLIB               14     //error from tpcc dblib txn module
#define ERR_TYPE_DELISRV                  15     //delivery server error
#define ERR_TYPE_TXNLOG                   16     //txn log error
#define ERR_TYPE_BCCONN                   17     //Benchcraft connection class
#define ERR_TYPE_TPCC_CONN                 18     //Benchcraft connection class
#define ERR_TYPE_ENCINA                    19     //Encina error
#define ERR_TYPE_COMPONENT                 20     //error from COM component
#define ERR_TYPE_RTE                       21     //Benchcraft rte
#define ERR_TYPE_AUTOMATION                22     //Benchcraft automation errors

class CBaseErr
{
public:
    char    *m_szApp;
    char    *m_szMsg;
    char    *m_szLoc; // code location where the error occurred
    int     m_idMsg;

    CBaseErr(void)
    {
        m_idMsg          = 0;
        m_szMsg          = new char[m_szMsg_size];
        m_szApp          = new char[m_szApp_size];
        m_szLoc          = NULL;

        m_szMsg[0]       = 0;
        m_szApp[0]       = 0;

        GetModuleFileName(GetModuleHandle(NULL), m_szApp, m_szApp_size);
    }
};
```

Appendix A - Application Source Code

```
virtual ~CBaseErr(void)
{
    if (m_szMsg)
        delete [] m_szMsg;
    if (m_szApp)
        delete [] m_szApp;
    if (m_szLoc)
        delete [] m_szLoc;
};

CBaseErr(int idMsg)
{
    m_idMsg          = idMsg;
    m_szApp          = new char[m_szApp_size];
    m_szMsg          = new char[m_szMsg_size];
    m_szLoc          = NULL;

    GetModuleFileName(GetModuleHandle(NULL), m_szApp, m_szApp_size);
    LoadString(GetModuleHandle(NULL), idMsg, m_szMsg, m_szMsg_size);
}

CBaseErr(LPCTSTR szMsg)
{
    m_idMsg          = 0;
    m_szApp          = new char[m_szApp_size];
    m_szMsg          = new char[m_szMsg_size];
    m_szLoc          = NULL;

    GetModuleFileName(GetModuleHandle(NULL), m_szApp, m_szApp_size);
    strcpy(m_szMsg, szMsg);
}

void SetError(char *szMsg, LPCTSTR szLocation)
{
    if (szMsg != NULL)
        strcpy(m_szMsg, szMsg);
    else
        m_szMsg[0] = 0;

    if (szLocation != NULL)
    {
        delete [] m_szLoc;
        m_szLoc = new char[strlen(szLocation)+1];
        strcpy(m_szLoc, szLocation);
    }
    else
    {
        delete [] m_szLoc;
        m_szLoc = NULL;
    }
}

virtual void Draw(HWND hwnd, LPCTSTR szStr = NULL)
{
    int      j;
    char    szTmp[512];

    if (szStr)
        j = wsprintf(szTmp, "%s\n", szStr);
    if (m_szLoc)
        j += wsprintf(szTmp+j, "Location=%s\n", m_szLoc);
    if (m_szMsg)
        j += wsprintf(szTmp+j, "%s\n", m_szMsg);
};
```

```
        ::MessageBox(hwnd, szTmp, m_szApp, MB_OK);
    }

    char *GetApp(void) { return m_szApp; }
    char *GetMsg(void) { return m_szMsg; }
    char *GetLocation(void) { return m_szLoc; }

    virtual int ErrorType() = 0; // a value which distinguishes the kind of error
    that occurred
    virtual int ErrorNum() = 0; // an error value specific to the error
    type
    virtual char *ErrorText() = 0; // a string (i.e., human readable)
    representation of the error
};

class CSocketErr : public CBaseErr
{
public:
    enum Action
    {
        eNone,
        eSend,
        eSocket,
        eConnect
    };

    CSocketErr(Action eAction, LPCTSTR szLocation);
    CSocketErr(int iError) { m_errId = iError; };
    int m_errId;
    Action m_eAction;

    int ErrorType() { return ERR_TYPE_SOCKET; };
    int ErrorNum() { return m_errId; };
    char *ErrorText(void);
};

class CSystemErr : public CBaseErr
{
public:
    enum Action
    {
        eNone,
        eTransactNamedPipe,
        eWaitNamedPipe,
        eSetNamedPipeHandleState,
        eCreateFile,
        eCreateProcess,
        eCallNamedPipe,
        eCreateEvent,
        eCreateThread,
        eVirtualAlloc,
        eReadFile,
        eWriteFile,
        eMapViewOfFile,
        eCreateFileMapping,
        eInitializeSecurityDescriptor,
        eSetSecurityDescriptorDacl,
        eCreateNamedPipe,
        eConnectNamedPipe,
        eWaitForSingleObject,
        eRegOpenKeyEx,
    };
};
```

Appendix A - Application Source Code

```
        eRegQueryValueEx,
    };

    CSystemErr(Action eAction, LPCTSTR szLocation);

    void Draw(HWND hwnd, LPCTSTR szStr = NULL);

    int          m_errId;
    Action      m_eAction;

    int ErrorType() { return ERR_TYPE_OS;}
    int ErrorNum() { return m_errId;}
    char *ErrorText() { return m_szMsg; }
};

class CMemoryErr : public CBaseErr
{
public:
    CMemoryErr(void);

    int ErrorType() { return ERR_TYPE_MEMORY;}
    int ErrorNum() { return 0;}
    char *ErrorText() { return "Insufficient Memory to continue.";}
};
```

common/src/trans.h

```
/*      FILE:          TRANS.H
 *
 *      Microsoft TPC-C Kit Ver. 4.20.000
 *      Copyright Microsoft, 1999
 *
 *      All Rights Reserved
 *
 *      Version 4.10.000 audited by Richard Gimarc,
 *      Performance Metrics, 3/17/99
 *
 *      PURPOSE:  Header file for TPC-C structure templates.
 *
 *      Change history:
 *      *      4.20.000 - updated rev number to match kit
 */
#pragma once

// String length constants
#define SERVER_NAME_LEN      20
#define DATABASE_NAME_LEN   20
#define USER_NAME_LEN       20
#define PASSWORD_LEN        20
#define TABLE_NAME_LEN    20
#define I_DATA_LEN          50
#define I_NAME_LEN          24
#define BRAND_LEN           1
#define LAST_NAME_LEN       16
#define W_NAME_LEN          10
#define ADDRESS_LEN         20
#define STATE_LEN           2
#define ZIP_LEN             9
#define S_DIST_LEN          24
#define S_DATA_LEN          50
```

```
#define D_NAME_LEN          10
#define FIRST_NAME_LEN     16
#define MIDDLE_NAME_LEN    2
#define PHONE_LEN          16
#define DATETIME_LEN       30
#define CREDIT_LEN         2
#define C_DATA_LEN         250
#define H_DATA_LEN         24
#define DIST_INFO_LEN      24
#define MAX_OL_NEW_ORDER_ITEMS 15
#define MAX_OL_ORDER_STATUS_ITEMS 15
#define STATUS_LEN         25
#define OL_DIST_INFO_LEN   24

// TIMESTAMP_STRUCT is provided by the ODBC header file sqltypes.h, but is not available
// when compiling with dblink, so redefined here. Note: we are using the symbol
// "__SQLTYPES"
// (declared in sqltypes.h) as a way to determine if TIMESTAMP_STRUCT has been declared.
#ifndef __SQLTYPES
typedef struct
{
    short          /* SQLSMALLINT */   year;
    unsigned short /* SQLUSMALLINT */  month;
    unsigned short /* SQLUSMALLINT */  day;
    unsigned short /* SQLUSMALLINT */  hour;
    unsigned short /* SQLUSMALLINT */  minute;
    unsigned short /* SQLUSMALLINT */  second;
    unsigned long  /* SQLINTEGER */    fraction;
} TIMESTAMP_STRUCT;
#endif

// possible values for exec_status_code after transaction completes
enum EXEC_STATUS
{
    eOK, // 0 "Transaction committed."
    eInvalidItem, // 1 "Item number is not valid."
    eDeliveryFailed // 2 "Delivery Post Failed."
};

// transaction structures
typedef struct
{
    // input params
    short          ol_supply_w_id;
    long           ol_i_id;
    short          ol_quantity;

    // output params
    char           ol_i_name[I_NAME_LEN+1];
    char           ol_brand_generic[BRAND_LEN+1];
    double         ol_i_price;
    double         ol_amount;
    short          ol_stock;
} OL_NEW_ORDER_DATA;

typedef struct
{
    // input params
    short          w_id;
    short          d_id;
    long           c_id;
    short          o_ol_cnt;
```

Appendix A - Application Source Code

```

// output params
EXEC_STATUS          exec_status_code;
char                 c_last[LAST_NAME_LEN+1];
char                 c_credit[CREDIT_LEN+1];
double              c_discount;
double              w_tax;
double              d_tax;
long                o_id;
short               o_commit_flag;
TIMESTAMP_STRUCT    o_entry_d;
short               o_all_local;
double              total_amount;
OL_NEW_ORDER_DATA  OL[MAX_OL_NEW_ORDER_ITEMS];
} NEW_ORDER_DATA, *PNEW_ORDER_DATA;

typedef struct
{
    // input params
    short          w_id;
    short          d_id;
    long           c_id;
    short          c_d_id;
    short          c_w_id;
    double         h_amount;
    char           c_last[LAST_NAME_LEN+1];

    // output params
    EXEC_STATUS    exec_status_code;
    TIMESTAMP_STRUCT h_date;
    char           w_street_1[ADDRESS_LEN+1];
    char           w_street_2[ADDRESS_LEN+1];
    char           w_city[ADDRESS_LEN+1];
    char           w_state[STATE_LEN+1];
    char           w_zip[ZIP_LEN+1];
    char           d_street_1[ADDRESS_LEN+1];
    char           d_street_2[ADDRESS_LEN+1];
    char           d_city[ADDRESS_LEN+1];
    char           d_state[STATE_LEN+1];
    char           d_zip[ZIP_LEN+1];
    char           c_first[FIRST_NAME_LEN+1];
    char           c_middle[MIDDLE_NAME_LEN + 1];
    char           c_street_1[ADDRESS_LEN+1];
    char           c_street_2[ADDRESS_LEN+1];
    char           c_city[ADDRESS_LEN+1];
    char           c_state[STATE_LEN+1];
    char           c_zip[ZIP_LEN+1];
    char           c_phone[PHONE_LEN+1];
    TIMESTAMP_STRUCT c_since;
    char           c_credit[CREDIT_LEN+1];
    double         c_credit_lim;
    double         c_discount;
    double         c_balance;
    char           c_data[200+1];
} PAYMENT_DATA, *PPAYMENT_DATA;

typedef struct
{
    long          ol_i_id;
    short         ol_supply_w_id;
    short         ol_quantity;
    double        ol_amount;
    TIMESTAMP_STRUCT ol_delivery_d;
} OL_ORDER_STATUS_DATA;

```

```

typedef struct
{
    // input params
    short          w_id;
    short          d_id;
    long           c_id;
    char           c_last[LAST_NAME_LEN+1];

    // output params
    EXEC_STATUS    exec_status_code;
    char           c_first[FIRST_NAME_LEN+1];
    char           c_middle[MIDDLE_NAME_LEN+1];
    double         c_balance;
    long           o_id;
    TIMESTAMP_STRUCT o_entry_d;
    short          o_carrier_id;
    OL_ORDER_STATUS_DATA OL[MAX_OL_ORDER_STATUS_ITEMS];
    short          o_ol_cnt;
} ORDER_STATUS_DATA, *PORDER_STATUS_DATA;

typedef struct
{
    // input params
    short          w_id;
    short          o_carrier_id;

    // output params
    EXEC_STATUS    exec_status_code;
    SYSTEMTIME     queue_time;
    long           o_id[10]; // id's of
} DELIVERED_ORDERS_DATA, *PDELIVERED_ORDERS_DATA;

//This structure is used for posting delivery transactions and for writing them to the
//delivery server.
typedef struct _DELIVERY_TRANSACTION
{
    SYSTEMTIME     queue; //time delivery transaction
    short          w_id; //delivery warehouse
    short          o_carrier_id; //carrier id
} DELIVERY_TRANSACTION;

typedef struct
{
    // input params
    short          w_id;
    short          d_id;
    short          threshold;

    // output params
    EXEC_STATUS    exec_status_code;
    long           low_stock;
} STOCK_LEVEL_DATA, *PSTOCK_LEVEL_DATA;

```

common/src/txn_base.h

```

/* FILE: TXN_BASE.H
 * Microsoft TPC-C Kit Ver. 4.20.000
 * Copyright Microsoft, 1999
 * All Rights Reserved

```

Appendix A - Application Source Code

```
*
*
*                               Version 4.10.000 audited by Richard Gimarc,
Performance Metrics, 3/17/99
*
*       PURPOSE:  Header file for TPC-C txn class implementation.
*
*       Change history:
*       4.20.000 - updated rev number to match kit
*/

#pragma once

// need to declare functions for import, unless define has already been created
// by the DLL's .cpp module for export.
#ifndef DllDecl
#define DllDecl __declspec( dllimport )
#endif

class DllDecl CTPCC_BASE
{
public:
    CTPCC_BASE(void) {};
    virtual ~CTPCC_BASE(void) {};

    virtual PNEW_ORDER_DATA      BuffAddr_NewOrder()
= 0;
    virtual PPAYMENT_DATA        BuffAddr_Payment()
= 0;
    virtual PDELIVERY_DATA       BuffAddr_Delivery()
= 0;
    virtual PSTOCK_LEVEL_DATA     BuffAddr_StockLevel()      = 0;
    virtual PORDER_STATUS_DATA    BuffAddr_OrderStatus()     = 0;

    virtual void NewOrder        () = 0;
    virtual void Payment         () = 0;
    virtual void Delivery        () = 0;
    virtual void StockLevel      () = 0;
    virtual void OrderStatus     () = 0;
};
```

db_dblib_dll/src/tpcc_dblib.cpp

```
/*      FILE:          TPCC_DBLIB.CPP
*
*      Microsoft TPC-C Kit Ver. 4.20.000
*      Copyright Microsoft, 1999
*
*      All Rights Reserved
*
*      Version 4.10.000 audited by Richard Gimarc,
Performance Metrics, 3/17/99
*
*      PURPOSE:  Implements dblib calls for TPC-C txns.
*      Contact:  Charles Levine (clevine@microsoft.com)
*
*      Change history:
*      4.20.000 - updated rev number to match kit
*      4.10.001 - not deleting error class in catch handler on deadlock
retry;
*
*                               not a functional bug, but a memory leak
```

```
*
*                               - had to tweak some declarations to compile with
latest SDK; no functional change
*/

#include <windows.h>
#include <stdio.h>
#include <assert.h>

#define DBNTWIN32
#include <sqlfront.h>
#include <sqlldb.h>

#ifndef ICECAP
#include <icapexp.h>
#endif

// need to declare functions for export
#define DllDecl __declspec( dllexport )

#include "..\..\common\src\error.h"
#include "..\..\common\src\trans.h"
#include "..\..\common\src\txn_base.h"
#include "tpcc_dblib.h"

#define DEFCLPACKSIZE          4096

// version string; must match return value from tpcc_version stored proc
const char      sVersion[] = "4.10.000";

const          iMaxRetries = 10;          // how many retries on
deadlock
static long     iConnectionCount = 0;    // number of current dblib connections

BOOL WINAPI DllMain(HMODULE hModule, DWORD ul_reason_for_call, LPVOID lpReserved)
{
    switch( ul_reason_for_call )
    {
        case DLL_PROCESS_ATTACH:
            DisableThreadLibraryCalls(hModule);
            dbinit();          // initialize dblib
            break;

        case DLL_PROCESS_DETACH:
            dbexit();          // close all dblib
            structures/connections
            break;

        default:
            /* nothing */;
    }
    return TRUE;
}

int err_handler(DBPROCESS *dbproc, int severity, int dberr, int oserr, LPCSTR dberrstr,
LPCSTR oserrstr)
{
    CTPCC_DBLIB          *pConn;

    assert(dbproc != NULL);
    pConn = (CTPCC_DBLIB*)dbgetuserdata(dbproc);

    if (pConn != NULL)
```

Appendix A - Application Source Code

```
{
    pConn->SetDbLibError( severity, dberr, oserr, dberrstr, oserrstr );
}
return INT_CANCEL;
}

/* FUNCTION: int msg_handler(DBPROCESS *dbproc, DBINT msgno, int msgstate, int severity,
char *msgtext)
*
* PURPOSE:      This function handles DB-Library SQL Server error messages
*
* ARGUMENTS:    DBPROCESS      *dbproc          DBPROCESS id
pointer
*
*              DBINT          msgno
*
*              int            msgstate
*
*              int            severity
*
*              char           *msgtext
*
*              printable message description
*
* RETURNS:      int            INT_CONTINUE
*
*              continue if error is SLETIME else INT_CANCEL action
*
*              INT_CANCEL     cancel operation
*
* COMMENTS:     This function also sets the dead lock dbproc variable if necessary.
*/

// typedef INT (SQLAPI *DBMSGHANDLE_PROC)(PDBPROCESS, DBINT, INT, INT, LPCSTR, LPCSTR,
LPCSTR, DBUSMALLINT);

int msg_handler(DBPROCESS *dbproc, DBINT msgno, int msgstate, int severity,
LPCSTR msgtext, LPCSTR srvname, LPCSTR procname,
DBUSMALLINT line)
{
    CTPCC_DBLIB          *pConn;

    assert(dbproc != NULL);
    pConn = (CTPCC_DBLIB*)dbgetuserdata(dbproc);

    if (pConn != NULL)
    {
        pConn->SetSqlError( msgno, msgstate, severity, msgtext );
    }

    return 0;
}

/* FUNCTION: void UtilStrCpy(char * pDest, char * pSrc, int n)
*
* PURPOSE:      This function copies n characters from string pSrc to pDst and places
a
*              null character at the end of the destination string.
*
* ARGUMENTS:    char           *pDest  destination string pointer
*              char           *pSrc   source
string pointer
*              int            n
*
*              number of characters to copy
*
```

```
* RETURNS:      None
*
* COMMENTS:     Unlike strncpy this function ensures that the result string is
*              always null terminated.
*/

inline static void UtilStrCpy(char * pDest, const BYTE * pSrc, int n)
{
    strncpy(pDest, (char *)pSrc, n);
    pDest[n] = '\0';

    return;
}

/* FUNCTION: CTPCC_DBLIB_ERR::ErrorText
*
*/

char* CTPCC_DBLIB_ERR::ErrorText(void)
{
    int i;

    static SERRORMSG errorMsgs[] =
    {
        { ERR_WRONG_SP_VERSION,          "Wrong version of stored
procs on database server" },
        { ERR_INVALID_CUST,              "Invalid Customer id.name." },
        { ERR_NO_SUCH_ORDER,             "No orders found for
customer." },
        { 0,                              },
    };

    static char szNotFound[] = "Unknown error number.";

    for(i=0; errorMsgs[i].szMsg[0]; i++)
    {
        if ( m_errno == errorMsgs[i].iError )
            break;
    }

    if ( !errorMsgs[i].szMsg[0] )
        return szNotFound;

    else
        return errorMsgs[i].szMsg;
}

// wrapper routine for class constructor
__declspec(dllexport) CTPCC_DBLIB* CTPCC_DBLIB_new(
LPCSTR szServer,          // name of SQL server
LPCSTR szUser,           // user name for login
LPCSTR szPassword,       // password for login
LPCSTR szHost,           // workstation name; shows up in
sp_who; max 30 chars, only first 10 kept by SQL Server
LPCSTR szDatabase )      // name of database to use
{
    return new CTPCC_DBLIB( szServer, szUser, szPassword, szHost, szDatabase );
}

CTPCC_DBLIB::CTPCC_DBLIB (
```

Appendix A - Application Source Code

```
LPCSTR szServer,           // name of SQL server
LPCSTR szUser,             // user name for login
LPCSTR szPassword,        // password for login
LPCSTR szHost,            // workstation name; shows up in
sp_who; max 30 chars, only first 10 kept by SQL Server
LPCSTR szDatabase )      // name of database to use
{
    LOGINREC *login;
    const BYTE *pData;

    // initialization
    m_dbproc = NULL;
    m_DbLibErr = (CDBLIBERR*)NULL;
    m_SqlErr = (CSQLERR*)NULL;

    m_MaxRetries = 10;           // how many retries on deadlock

    // increase max number of connections if getting close
    if ( dbgetmaxprocs() < (iConnectionCount+5) )
    {
        if ( dbsetmaxprocs(iConnectionCount+10) == FAIL )
            ThrowError(CDBLIBERR::eDbSetMaxProcs);
    }

    // allocate a login structure
    login = dblogin();
    if (login == NULL)
        ThrowError(CDBLIBERR::eLogin);
    InterlockedIncrement( &iConnectionCount );

    // register error and message handler functions
    if (dbprocerrhandle(login, err_handler) == NULL)
        ThrowError(CDBLIBERR::eDbProcHandler);

    if (dbprocmshandle(login, msg_handler) == NULL)
        ThrowError(CDBLIBERR::eDbProcHandler);

    DBSETLUSER(login, szUser);
    DBSETLPWD(login, szPassword);
    DBSETLHOST(login, szHost);
    DBSETLPACKET(login, (unsigned short)DEFCLPACKSIZE);
    DBSETLVERSION(login, DBVER60); // use dblink ver 6.0 client

behavior

    // set time to wait for login
    if (dbsetlogintime(60) == FAIL)
        ThrowError(CDBLIBERR::eDbSet);

    // set time to wait for statement execution
    if (dbsettime(180) == FAIL)
        ThrowError(CDBLIBERR::eDbSet);

    m_dbproc = dbopen(login, szServer);

    // deallocate login structure before checking for success
    dbfreelogin( login );

    if (m_dbproc == NULL)
        ThrowError(CDBLIBERR::eDbOpen);

    // save address of class instance so that the message and error handler
    // can get to data.
```

```
dbsetuserdata(m_dbproc, (LPVOID)this);

    // Use the the right database
    if (dbuse(m_dbproc, szDatabase) == FAIL)
        ThrowError(CDBLIBERR::eDbUse);

    dbcmd(m_dbproc, "set nocount on "); // do not return
row counts
    dbcmd(m_dbproc, "set XACT_ABORT ON"); // rollback transaction on
abort

    if (dbsqlxexec(m_dbproc) == FAIL)
        ThrowError(CDBLIBERR::eDbSqlExec);

    DiscardNextResults(2);

    // verify that version of stored procs on server is correct
    dbrpcinit(m_dbproc, "tpcc_version", 0);

    if (dbrpcexec(m_dbproc) == FAIL)
        ThrowError(CDBLIBERR::eDbRpcExec);

    if (dbresults(m_dbproc) != SUCCEED)
        ThrowError(CDBLIBERR::eDbResults);

    if (dbnextrow(m_dbproc) != REG_ROW)
        ThrowError(CDBLIBERR::eDbNextRow);

    char szSrvVersion[16];
    pData=dbdata(m_dbproc, 1);
    if (pData)
        UtilStrCpy(szSrvVersion, pData, dbdatlen(m_dbproc, 1));
    else
        szSrvVersion[0]=0;
    if (strcmp(szSrvVersion,sVersion))
        throw new CTPCC_DBLIB_ERR( CTPCC_DBLIB_ERR::ERR_WRONG_SP_VERSION );

    DiscardNextRows(0);
    DiscardNextResults(0);
}

CTPCC_DBLIB::~CTPCC_DBLIB( void )
{
    // close db connection and deallocate resources
    dbclose(m_dbproc);
    InterlockedDecrement( &iConnectionCount );
    if (m_DbLibErr != NULL)
        delete m_DbLibErr;
    if (m_SqlErr != NULL)
        delete m_SqlErr;
}

void CTPCC_DBLIB::SetDbLibError(int severity, int dberr, int oserr, LPCSTR dberrstr,
LPCSTR oserrstr)
{
    delete m_DbLibErr;
    m_DbLibErr = new CDBLIBERR(CDBLIBERR::eUnknown, severity, dberr, oserr);

    if (dberrstr != NULL)
    {
        m_DbLibErr->m_dberrstr = new char[ strlen(dberrstr)+1 ];
```

Appendix A - Application Source Code

```
        strcpy( m_DbLibErr->m_dberrstr, dberrstr );
    }
    if (oserrstr != NULL)
    {
        m_DbLibErr->m_oserrstr = new char[ strlen(oserrstr)+1 ];
        strcpy( m_DbLibErr->m_oserrstr, oserrstr );
    }
}

void CTPCC_DBLIB::SetSqlError( int /*DBINT*/ msgno, int msgstate, int severity, LPCSTR
msgtext )
{
    if (m_SqlErr == NULL)
        m_SqlErr = new CSQLErr();

    m_SqlErr->m_msgno = msgno;
    m_SqlErr->m_msgstate = msgstate;
    m_SqlErr->m_severity = severity;

    delete [] m_SqlErr->m_msgtext;
    if (msgtext != NULL)
    {
        m_SqlErr->m_msgtext = new char[ strlen(msgtext)+1 ];
        strcpy( m_SqlErr->m_msgtext, msgtext );
    }
}

void CTPCC_DBLIB::ThrowError( CDBLIBERR::ACTION eAction )
{
    // discard anything still in return buffer
    DiscardNextRows(-1);
    DiscardNextResults(-1);

    // check for SQL Server error first; if yes, throw it and ignore any Dblib
error.
    if (m_SqlErr != NULL)
    {
        CSQLErr *pSqlErr;
        pSqlErr = m_SqlErr;
        m_SqlErr = NULL; // clear our pointer to instance; catch handler
will delete
    }
        throw pSqlErr;

    CDBLIBERR *pDbLibErr;
    if (m_DbLibErr == NULL)
was returned
        // this case isn't expected to happen, since it means that an error
        // but the error handlers were not called.
        pDbLibErr = new CDBLIBERR(eAction);
    else
    {
        pDbLibErr = m_DbLibErr;
        pDbLibErr->m_eAction = eAction;
        m_DbLibErr = NULL; // clear our pointer to instance; catch
handler will delete
    }
        throw pDbLibErr;
}
}
```

```
// Read and discard rows until no more. Throw an exception if number of rows read
doesn't
// match number of rows expected. The row count will be ignored if the expected count
value
// passed in is negative. A typical use of this routine is to verify that there are no
more
// rows to be read.
void CTPCC_DBLIB::DiscardNextRows(int iExpectedCount)
{
    int          iRowsRead = 0;
    RETCODE     rc;

    while (TRUE)
    {
        rc = dbnextrow(m_dbproc);
        if (rc == NO_MORE_ROWS)
            break;
        if (rc == FAIL)
        {
            if (iExpectedCount >= 0)
                ThrowError(CDBLIBERR::eDbNextRow);
            else
                break;
        }
        iRowsRead++;
    }

    if ((iExpectedCount >= 0) &&
        (iExpectedCount != iRowsRead))
        ThrowError(CDBLIBERR::eWrongRowCount);
}

// Read and discard results until no more. Throw an exception if number of result sets
read doesn't
// match number expected. The result set count will be ignored if the expected count
value
// passed in is negative. A typical use of this routine is to verify that there are no
more
// result sets to be read.
void CTPCC_DBLIB::DiscardNextResults(int iExpectedCount)
{
    int          iResultsRead = 0;
    RETCODE     rc;

    while (TRUE)
    {
        rc = dbresults(m_dbproc);
        if (rc == NO_MORE_RESULTS)
            break;
        if (rc == FAIL)
        {
            if (iExpectedCount >= 0)
                ThrowError(CDBLIBERR::eDbResults);
            else
                break;
        }

        DiscardNextRows(-1);
        iResultsRead++;
    }

    if ((iExpectedCount >= 0) &&
        (iExpectedCount != iResultsRead))
```

Appendix A - Application Source Code

```
        ThrowError(CDBLIBERR::eWrongRowCount);
    }
}

void CTPCC_DBLIB::StockLevel()
{
    int                iTryCount = 0;
    const BYTE        *pData;

    ResetError();

    while (TRUE)
    {
        try
        {
            dbrpcinit(m_dbproc, "tpcc_stocklevel", 0);

            dbrpcparam(m_dbproc, NULL, 0, SQLINT2, -1, -1, (BYTE *)
                &m_txn.StockLevel.w_id); // @w_id smallint
            dbrpcparam(m_dbproc, NULL, 0, SQLINT1, -1, -1, (BYTE *)
                &m_txn.StockLevel.d_id); // @d_id tinyint
            dbrpcparam(m_dbproc, NULL, 0, SQLINT2, -1, -1, (BYTE *)
                &m_txn.StockLevel.threshold); // @threshold smallint

            if (dbrpcexec(m_dbproc) == FAIL)
                ThrowError(CDBLIBERR::eDbRpcExec);

            if (dbresults(m_dbproc) != SUCCEED)
                ThrowError(CDBLIBERR::eDbResults);

            if (dbnextrow(m_dbproc) != REG_ROW)
                ThrowError(CDBLIBERR::eDbNextRow);

            if (pData=dbdata(m_dbproc, 1))
                m_txn.StockLevel.low_stock = *((long *) pData);

            DiscardNextRows(0);
            DiscardNextResults(0);

            m_txn.StockLevel.exec_status_code = eOK;
            return;
        }
        catch (CSQLERR *e)
        {
            if ((e->m_msgno != 1205) || (++iTryCount > iMaxRetries))
                throw;

            // hit deadlock; backoff for increasingly longer period
            delete e;
            Sleep(10 * iTryCount);
        }
    } // while (TRUE)
}

void CTPCC_DBLIB::NewOrder()
{
    int                i;
    DBINT              commit_flag;
    DBDATETIME         datetime;
    DBDATEREC          daterec;

    int                iTryCount = 0;
    const BYTE        *pData;
```

```
    ResetError();

    while (TRUE)
    {
        try
        {
            dbrpcinit(m_dbproc, "tpcc_neworder", 0);

            dbrpcparam(m_dbproc, NULL, 0, SQLINT2, -1, -1, (BYTE *)
                &m_txn.NewOrder.w_id);
            dbrpcparam(m_dbproc, NULL, 0, SQLINT1, -1, -1, (BYTE *)
                &m_txn.NewOrder.d_id);
            dbrpcparam(m_dbproc, NULL, 0, SQLINT4, -1, -1, (BYTE *)
                &m_txn.NewOrder.c_id);
            dbrpcparam(m_dbproc, NULL, 0, SQLINT1, -1, -1, (BYTE *)
                &m_txn.NewOrder.o_ol_cnt);

            // check whether any order lines are for a remote warehouse
            m_txn.NewOrder.o_all_local = 1;
            for (i = 0; i < m_txn.NewOrder.o_ol_cnt; i++)
            {
                if (m_txn.NewOrder.OL[i].ol_supply_w_id !=
                    m_txn.NewOrder.w_id)
                {
                    m_txn.NewOrder.o_all_local = 0; // at
                    break;
                }
            }
            dbrpcparam(m_dbproc, NULL, 0, SQLINT1, -1, -1, (BYTE *)
                &m_txn.NewOrder.o_all_local);

            for (i = 0; i < m_txn.NewOrder.o_ol_cnt; i++)
            {
                dbrpcparam(m_dbproc, NULL, 0, SQLINT4, -1, -1,
                    (BYTE *) &m_txn.NewOrder.OL[i].ol_i_id);
                dbrpcparam(m_dbproc, NULL, 0, SQLINT2, -1, -1,
                    (BYTE *) &m_txn.NewOrder.OL[i].ol_supply_w_id);
                dbrpcparam(m_dbproc, NULL, 0, SQLINT2, -1, -1,
                    (BYTE *) &m_txn.NewOrder.OL[i].ol_quantity);
            }

            if (dbrpcexec(m_dbproc) == FAIL)
                ThrowError(CDBLIBERR::eDbRpcExec);

            // Get order line results
            m_txn.NewOrder.total_amount = 0;
            for (i = 0; i < m_txn.NewOrder.o_ol_cnt; i++)
            {
                if (dbresults(m_dbproc) != SUCCEED)
                    ThrowError(CDBLIBERR::eDbResults);

                if (dbnumcols(m_dbproc) != 5)
                    ThrowError(CDBLIBERR::eWrongNumCols);

                if (dbnextrow(m_dbproc) != REG_ROW)
                    ThrowError(CDBLIBERR::eDbNextRow);

                if (pData=dbdata(m_dbproc, 1))

                    UtilStrCpy(m_txn.NewOrder.OL[i].ol_i_name, pData, dbdatlen(m_dbproc, 1));
            }
        }
    }
}
```

Appendix A - Application Source Code

```
&m_txn.Payment.c_id);
    dbrpcparam(m_dbproc, NULL, 0, SQLINT4, -1, -1, (BYTE *)
    // if customer id is zero, then payment is by name
    if (m_txn.Payment.c_id == 0)
        dbrpcparam(m_dbproc, NULL, 0, SQLCHAR, -1,
strlen(m_txn.Payment.c_last), (unsigned char *)m_txn.Payment.c_last);
    if (dbrpcexec(m_dbproc) == FAIL)
        ThrowError(CDBLIBERR::eDbRpcExec);
    if (dbresults(m_dbproc) != SUCCEEDED)
        ThrowError(CDBLIBERR::eDbResults);
    if (dbnextrow(m_dbproc) != REG_ROW)
        ThrowError(CDBLIBERR::eDbNextRow);
    if (dbnumcols(m_dbproc) != 27)
        ThrowError(CDBLIBERR::eWrongNumCols);
    if (pData=dbdata(m_dbproc, 1))
        m_txn.Payment.c_id = *((DBINT *) pData);
    if (pData=dbdata(m_dbproc, 2))
        UtilStrCpy(m_txn.Payment.c_last, pData,
dbdatlen(m_dbproc, 2));
    if (pData=dbdata(m_dbproc, 3))
    {
        datetime = *((DBDATETIME *) pData);
        dbdatecrack(m_dbproc, &daterec, &datetime);
        m_txn.Payment.h_date.year = daterec.year;
        m_txn.Payment.h_date.month = daterec.month;
        m_txn.Payment.h_date.day = daterec.day;
        m_txn.Payment.h_date.hour = daterec.hour;
        m_txn.Payment.h_date.minute = daterec.minute;
        m_txn.Payment.h_date.second = daterec.second;
    }
    if (pData=dbdata(m_dbproc, 4))
        UtilStrCpy(m_txn.Payment.w_street_1, pData,
dbdatlen(m_dbproc, 4));
    if (pData=dbdata(m_dbproc, 5))
        UtilStrCpy(m_txn.Payment.w_street_2, pData,
dbdatlen(m_dbproc, 5));
    if (pData=dbdata(m_dbproc, 6))
        UtilStrCpy(m_txn.Payment.w_city, pData,
dbdatlen(m_dbproc, 6));
    if (pData=dbdata(m_dbproc, 7))
        UtilStrCpy(m_txn.Payment.w_state, pData,
dbdatlen(m_dbproc, 7));
    if (pData=dbdata(m_dbproc, 8))
        UtilStrCpy(m_txn.Payment.w_zip, pData,
dbdatlen(m_dbproc, 8));
    if (pData=dbdata(m_dbproc, 9))
        UtilStrCpy(m_txn.Payment.d_street_1, pData,
dbdatlen(m_dbproc, 9));
    if (pData=dbdata(m_dbproc, 10))
        UtilStrCpy(m_txn.Payment.d_street_2, pData,
dbdatlen(m_dbproc, 10));
    if (pData=dbdata(m_dbproc, 11))
        UtilStrCpy(m_txn.Payment.d_city, pData,
dbdatlen(m_dbproc, 11));
    if (pData=dbdata(m_dbproc, 12))
        UtilStrCpy(m_txn.Payment.d_state, pData,
```

```
if (pData=dbdata(m_dbproc, 13))
    UtilStrCpy(m_txn.Payment.d_zip, pData,
dbdatlen(m_dbproc, 13));
    if (pData=dbdata(m_dbproc, 14))
        UtilStrCpy(m_txn.Payment.c_first, pData,
dbdatlen(m_dbproc, 14));
    if (pData=dbdata(m_dbproc, 15))
        UtilStrCpy(m_txn.Payment.c_middle, pData,
dbdatlen(m_dbproc, 15));
    if (pData=dbdata(m_dbproc, 16))
        UtilStrCpy(m_txn.Payment.c_street_1, pData,
dbdatlen(m_dbproc, 16));
    if (pData=dbdata(m_dbproc, 17))
        UtilStrCpy(m_txn.Payment.c_street_2, pData,
dbdatlen(m_dbproc, 17));
    if (pData=dbdata(m_dbproc, 18))
        UtilStrCpy(m_txn.Payment.c_city, pData,
dbdatlen(m_dbproc, 18));
    if (pData=dbdata(m_dbproc, 19))
        UtilStrCpy(m_txn.Payment.c_state, pData,
dbdatlen(m_dbproc, 19));
    if (pData=dbdata(m_dbproc, 20))
        UtilStrCpy(m_txn.Payment.c_zip, pData,
dbdatlen(m_dbproc, 20));
    if (pData=dbdata(m_dbproc, 21))
        UtilStrCpy(m_txn.Payment.c_phone, pData,
dbdatlen(m_dbproc, 21));
    if (pData=dbdata(m_dbproc, 22))
    {
        datetime = *((DBDATETIME *) pData);
        dbdatecrack(m_dbproc, &daterec, &datetime);
        m_txn.Payment.c_since.year = daterec.year;
        m_txn.Payment.c_since.month = daterec.month;
        m_txn.Payment.c_since.day = daterec.day;
        m_txn.Payment.c_since.hour = daterec.hour;
        m_txn.Payment.c_since.minute = daterec.minute;
        m_txn.Payment.c_since.second = daterec.second;
    }
    if (pData=dbdata(m_dbproc, 23))
        UtilStrCpy(m_txn.Payment.c_credit, pData,
dbdatlen(m_dbproc, 23));
    if (pData=dbdata(m_dbproc, 24))
        dbconvert(m_dbproc, SQLNUMERIC, pData,
dbdatlen(m_dbproc,24), SQLFLT8, (BYTE *)&m_txn.Payment.c_credit_lim, 8);
    if (pData=dbdata(m_dbproc, 25))
        dbconvert(m_dbproc, SQLNUMERIC, pData,
dbdatlen(m_dbproc,25), SQLFLT8, (BYTE *)&m_txn.Payment.c_discount, 8);
    if (pData=dbdata(m_dbproc, 26))
        dbconvert(m_dbproc, SQLNUMERIC, pData,
dbdatlen(m_dbproc,26), SQLFLT8, (BYTE *)&m_txn.Payment.c_balance, 8);
    if (pData=dbdata(m_dbproc, 27))
        UtilStrCpy(m_txn.Payment.c_data, pData,
dbdatlen(m_dbproc, 27));
    DiscardNextRows(0);
    DiscardNextResults(0);
    if (m_txn.Payment.c_id == 0)
        throw new CTPCC_DBLIB_ERR(
CTPCC_DBLIB_ERR::ERR_INVALID_CUST );
    else
        m_txn.Payment.exec_status_code = eOK;
```

Appendix A - Application Source Code

```
        return;
    }
    catch (CSQLERR *e)
    {
        if ((e->m_msgno != 1205) || (++iTryCount > iMaxRetries))
            throw;

        // hit deadlock; backoff for increasingly longer period
        delete e;
        Sleep(10 * iTryCount);
    }
    // while (TRUE)
}

void CTPCC_DBLIB::OrderStatus()
{
    int i;
    DBDATETIME datetime;
    DBDATEREC daterec;

    int iTryCount = 0;
    RETCODE rc;
    const BYTE *pData;

    ResetError();

    while (TRUE)
    {
        try
        {
            dbrpcinit(m_dbproc, "tpcc_orderstatus", 0);
            dbrpcparam(m_dbproc, NULL, 0, SQLINT2, -1, -1, (BYTE *)
&m_txn.OrderStatus.w_id);
            dbrpcparam(m_dbproc, NULL, 0, SQLINT1, -1, -1, (BYTE *)
&m_txn.OrderStatus.d_id);
            dbrpcparam(m_dbproc, NULL, 0, SQLINT4, -1, -1, (BYTE *)
&m_txn.OrderStatus.c_id);

            // if customer id is zero, then order status is by name
            if (m_txn.OrderStatus.c_id == 0)
                dbrpcparam(m_dbproc, NULL, 0, SQLCHAR, -1,
strlen(m_txn.OrderStatus.c_last), (unsigned char *)m_txn.OrderStatus.c_last);

            if (dbrpcexec(m_dbproc) == FAIL)
                ThrowError(CDBLIBERR::eDbRpcExec);

            // Get order lines
            if (dbresults(m_dbproc) != SUCCEED)
            {
                if ((m_DbLibErr == NULL) && (m_SqlErr == NULL))
                    throw new CTPCC_DBLIB_ERR(
CTPCC_DBLIB_ERR::ERR_NO_SUCH_ORDER );
                else
                    ThrowError(CDBLIBERR::eDbResults);
            }

            if (dbnumcols(m_dbproc) != 5)
                ThrowError(CDBLIBERR::eWrongNumCols);
        }
    }
}
```

```
        i = 0;
        while (TRUE)
        {
            rc = dbnextrow(m_dbproc);
            if (rc == NO_MORE_ROWS)
                break;
            if (rc != REG_ROW)
                ThrowError(CDBLIBERR::eDbNextRow);

            if (pData=dbdata(m_dbproc, 1))
                m_txn.OrderStatus.OL[i].ol_supply_w_id
= (*(DBSMALLINT *) pData);

            if (pData=dbdata(m_dbproc, 2))
                m_txn.OrderStatus.OL[i].ol_i_id =
(*(DBINT *) pData);

            if (pData=dbdata(m_dbproc, 3))
                m_txn.OrderStatus.OL[i].ol_quantity =
(*(DBSMALLINT *) pData);

            if (pData=dbdata(m_dbproc, 4))
                dbconvert(m_dbproc, SQLNUMERIC, pData,
SQLFLT8, (BYTE
*)&m_txn.OrderStatus.OL[i].ol_amount, 8);

            if (pData=dbdata(m_dbproc, 5))
            {
                datetime = *((DBDATETIME *) pData);
                dbdatecrack(m_dbproc, &daterec,
&datetime);

                m_txn.OrderStatus.OL[i].ol_delivery_d.year = daterec.year;
                m_txn.OrderStatus.OL[i].ol_delivery_d.month = daterec.month;
                m_txn.OrderStatus.OL[i].ol_delivery_d.day = daterec.day;
                m_txn.OrderStatus.OL[i].ol_delivery_d.hour = daterec.hour;
                m_txn.OrderStatus.OL[i].ol_delivery_d.minute = daterec.minute;
                m_txn.OrderStatus.OL[i].ol_delivery_d.second = daterec.second;
            }
            i++;
            m_txn.OrderStatus.o_ol_cnt = i;

            if (dbresults(m_dbproc) != SUCCEED)
                ThrowError(CDBLIBERR::eDbResults);

            if (dbnextrow(m_dbproc) != REG_ROW)
                ThrowError(CDBLIBERR::eDbNextRow);

            if (dbnumcols(m_dbproc) != 8)
                ThrowError(CDBLIBERR::eWrongNumCols);

            if (pData=dbdata(m_dbproc, 1))
                m_txn.OrderStatus.c_id = (*(DBINT *) pData);
            if (pData=dbdata(m_dbproc, 2))
                UtilStrCpy(m_txn.OrderStatus.c_last, pData,
dbdatlen(m_dbproc,2));

            if (pData=dbdata(m_dbproc, 3))
```

Appendix A - Application Source Code

```
        UtilStrCpy(m_txn.OrderStatus.c_first, pData,
dbdatlen(m_dbproc,3));
        if(pData=dbdata(m_dbproc, 4))
            UtilStrCpy(m_txn.OrderStatus.c_middle, pData,
dbdatlen(m_dbproc, 4));
        if(pData=dbdata(m_dbproc, 5))
        {
            datetime = *((DBDATETIME *) pData);
            dbdatecrack(m_dbproc, &daterec, &datetime);
            m_txn.OrderStatus.o_entry_d.year =
daterec.year;
            m_txn.OrderStatus.o_entry_d.month =
daterec.month;
            m_txn.OrderStatus.o_entry_d.day = daterec.day;
            m_txn.OrderStatus.o_entry_d.hour =
daterec.hour;
            m_txn.OrderStatus.o_entry_d.minute =
daterec.minute;
            m_txn.OrderStatus.o_entry_d.second =
daterec.second;
        }
        if(pData=dbdata(m_dbproc, 6))
            m_txn.OrderStatus.o_carrier_id = (*(DBSMALLINT *)
pData);
        if(pData=dbdata(m_dbproc, 7))
            dbconvert(m_dbproc, SQLNUMERIC, pData,
SQLFLT8, (BYTE
dbdatlen(m_dbproc,7),
*)&m_txn.OrderStatus.c_balance, 8);
        if(pData=dbdata(m_dbproc, 8))
            m_txn.OrderStatus.o_id = (*(DBINT *) pData);

        DiscardNextRows(0);
        DiscardNextResults(0);

        if (m_txn.OrderStatus.o_ol_cnt == 0)
            throw new CTPCC_DBLIB_ERR(
CTPCC_DBLIB_ERR::ERR_NO_SUCH_ORDER );
        else if (m_txn.OrderStatus.c_id == 0 &&
m_txn.OrderStatus.c_last[0] == 0)
            throw new CTPCC_DBLIB_ERR(
CTPCC_DBLIB_ERR::ERR_INVALID_CUST );
        else
            m_txn.OrderStatus.exec_status_code = eOK;

        return;
    }
    catch (CSQLERR *e)
    {
        if ((e->m_msgno != 1205) || (++iTryCount > iMaxRetries))
            throw;

        // hit deadlock; backoff for increasingly longer period
        delete e;
        Sleep(10 * iTryCount);
    }
}
// while (TRUE)

void CTPCC_DBLIB::Delivery()
{
```

```
    int
    int
    const BYTE
    *pData;

    ResetError();

    while (TRUE)
    {
        try
        {
            dbrpcinit(m_dbproc, "tpcc_delivery", 0);
            dbrpcparam(m_dbproc, NULL, 0, SQLINT2, -1, -1, (BYTE *)
&m_txn.Delivery.w_id);
            dbrpcparam(m_dbproc, NULL, 0, SQLINT1, -1, -1, (BYTE *)
&m_txn.Delivery.o_carrier_id);

            if (dbrpcexec(m_dbproc) == FAIL)
                ThrowError(CDBLIBERR::eDbRpcExec);

            if (dbresults(m_dbproc) != SUCCEEDED)
                ThrowError(CDBLIBERR::eDbResults);

            if (dbnextrow(m_dbproc) != REG_ROW)
                ThrowError(CDBLIBERR::eDbNextRow);

            if (dbnumcols(m_dbproc) != 10)
                ThrowError(CDBLIBERR::eWrongNumCols);

            for (i=0; i<10; i++)
            {
                if (pData = dbdata(m_dbproc, i+1))
                    m_txn.Delivery.o_id[i] = (*(DBINT
*)pData);
            }

            DiscardNextRows(0);
            DiscardNextResults(0);

            m_txn.Delivery.exec_status_code = eOK;
            return;
        }
        catch (CSQLERR *e)
        {
            if ((e->m_msgno != 1205) || (++iTryCount > iMaxRetries))
                throw;

            // hit deadlock; backoff for increasingly longer period
            delete e;
            Sleep(10 * iTryCount);
        }
    }
}
// while (TRUE)

void CTPCC_DBLIB::ResetError()
{
    if (m_DbLibErr != NULL)
    {
        delete m_DbLibErr;
        m_DbLibErr = (CDBLIBERR*)NULL;
    }

    if (m_SqlErr != NULL)
```

Appendix A - Application Source Code

```
{
    delete m_SqlErr;
    m_SqlErr = (CSQLERR*)NULL;
}
return;
}
```

db_dblib_dll/src/tpcc_dblib.h

```
/* FILE: TPCC_DBLIB.H
 * Microsoft TPC-C Kit Ver. 4.20.000
 * Copyright Microsoft, 1999
 * All Rights Reserved
 *
 * Version 4.10.000 audited by Richard Gimarc,
 * Performance Metrics, 3/17/99
 *
 * PURPOSE: Header file for TPC-C txn class implementation.
 *
 * Change history:
 * 4.20.000 - updated rev number to match kit
 */
#pragma once

#ifndef PDBPROCESS
#define DBPROCESS void // dbprocess structure type
typedef DBPROCESS * PDBPROCESS;
#endif

// need to declare functions for import, unless define has already been created
// by the DLL's .cpp module for export.
#ifndef DllDecl
#define DllDecl __declspec( dllimport )
#endif

class CSQLERR : public CBaseErr
{
public:
    CSQLERR(void)
    {
        m_msgno = 0;
        m_msgstate = 0;
        m_severity = 0;
        m_msgtext = NULL;
    };

    ~CSQLERR()
    {
        delete [] m_msgtext;
    };

    int m_msgno;
    int m_msgstate;
    int m_severity;
    char *m_msgtext;

    int ErrorType() {return ERR_TYPE_SQL;};
    int ErrorNum() {return m_msgno;};
};
```

```
char *ErrorText() {return m_msgtext;};
};

class CDBLIBERR : public CBaseErr
{
public:
    enum ACTION
    {
        eNone,
        eUnknown,
        eLogin, // error from
        eDbOpen, // error from dbopen
        eDbUse, // error from dbuse
        eDbSqlExec, // error from
        eDbSet, // error from one
        eDbNextRow, // error from
        eWrongRowCount, // more or less rows returned
        eWrongNumCols, // more or less columns
        eDbResults, // error from
        eDbRpcExec, // error from
        eDbSetMaxProcs, // error from dbsetmaxprocs
        eDbProcHandler // error from either
    };

    dblogin
    dbsqlxec
    of the dbset* routines
    dbnextrow
    than expected
    returned than expected
    dbresults
    dbrpcxec
    dbprocerrhandle or dbprocmsghandle
    };

    CDBLIBERR(ACTION eAction, int severity = 0, int dberror = 0, int
    oserr = 0)
    {
        m_eAction = eAction;
        m_severity = severity;
        m_dberror = dberror;
        m_oserr = oserr;

        m_dberrstr = NULL;
        m_oserrstr = NULL;
    };

    ~CDBLIBERR()
    {
        delete [] m_dberrstr;
        delete [] m_oserrstr;
    };

    ACTION m_eAction;
    int m_severity;
    int m_dberror;
    int m_oserr;
    char *m_dberrstr;
    char *m_oserrstr;

    int ErrorType() {return ERR_TYPE_DBLIB;};
    int ErrorNum() {return m_dberror;};
    char *ErrorText() {return m_dberrstr;};
};
```

Appendix A - Application Source Code

```
};

class CTPCC_DBLIB_ERR : public CBaseErr
{
public:
    enum CTPCC_DBLIB_ERRS
    {
        ERR_WRONG_SP_VERSION = 1, // "Wrong version of stored
procs on database server"
        ERR_INVALID_CUST, // "Invalid
Customer id,name."
        ERR_NO_SUCH_ORDER // "No orders found
for customer."
    };

    CTPCC_DBLIB_ERR( int iErr ) { m_errno = iErr; };

    int m_errno;

    int ErrorType() {return ERR_TYPE_TPCC_DBLIB;};
    int ErrorNum() {return m_errno;};

    char *ErrorText();
};

class DllDecl CTPCC_DBLIB : public CTPCC_BASE
{
private:
    // declare variables and private functions here...
    PDBPROCESS m_dbproc;
    CDBLIBERR *m_DbLibErr; // not allocated until needed
(maybe never)
    CSQLErr *m_SqlErr; // not
allocated until needed (maybe never)
    int m_MaxRetries; // retry
count on deadlock

    void DiscardNextRows(int iExpectedCount);
    void DiscardNextResults(int iExpectedCount);
    void ThrowError( CDBLIBERR::ACTION eAction );
    void ResetError();

    union
    {
        NEW_ORDER_DATA NewOrder;
        PAYMENT_DATA Payment;
        DELIVERY_DATA Delivery;
        STOCK_LEVEL_DATA StockLevel;
        ORDER_STATUS_DATA OrderStatus;
        m_txn;
    }

public:
    CTPCC_DBLIB(LPCSTR szServer, LPCSTR szUser, LPCSTR szPassword, LPCSTR
szHost, LPCSTR szDatabase );
    ~CTPCC_DBLIB(void);

    inline PNEW_ORDER_DATA BuffAddr_NewOrder()
    { return &m_txn.NewOrder; };
    inline PPAYMENT_DATA BuffAddr_Payment()
    { return &m_txn.Payment; };
    inline PDELIVERY_DATA BuffAddr_Delivery()
    { return &m_txn.Delivery; };
};
```

```
inline PSTOCK_LEVEL_DATA BuffAddr_StockLevel() { return
&m_txn.StockLevel; };
inline PORDER_STATUS_DATA BuffAddr_OrderStatus() { return
&m_txn.OrderStatus; };

void NewOrder ();
void Payment ();
void Delivery ();
void StockLevel ();
void OrderStatus ();

// these are public because they must be called from the dblib
err_handler and msg_hangler
// outside of the class
void SetDbLibError(int severity, int dberr, int oserr, LPCSTR
dberrstr, LPCSTR oserrstr);
void SetSqlError( int msgno, int msgstate, int severity, LPCSTR
msgtext );
};

extern "C" DllDecl CTPCC_DBLIB* CTPCC_DBLIB_new
( LPCSTR szServer, LPCSTR szUser, LPCSTR szPassword, LPCSTR szHost, LPCSTR
szDatabase );

typedef CTPCC_DBLIB* (TYPE_CTPCC_DBLIB)(LPCSTR, LPCSTR, LPCSTR, LPCSTR, LPCSTR);
```

tm_com_dll/src/tpcc_com.cpp

```
/* FILE: TPCC_COM.CPP
 * Microsoft TPC-C Kit Ver. 4.20.000
 * Copyright Microsoft, 1999
 * All Rights Reserved
 * not yet audited
 * PURPOSE: Source file for TPC-C COM+ class implementation.
 * Contact: Charles Levine (clevine@microsoft.com)
 * Change history:
 * 4.20.000 - first version
 */

// needed for CoinitializeEx
#define _WIN32_WINNT 0x0400

#include <windows.h>

// need to declare functions for export
#define DllDecl __declspec( dllexport )

#include "..\..\common\src\tans.h" //tpckit transaction header contains
definitions of structures specific to TPC-C
#include "..\..\common\src\error.h"
#include "..\..\common\src\txn_base.h"
#include "tpcc_com.h"

#include "..\..\tpcc_com_ps\src\tpcc_com_ps_i.c"
```

Appendix A - Application Source Code

```
#include "..\..\tpcc_com_all\src\tpcc_com_all.i.c"

// wrapper routine for class constructor
_declspec(dllexport) CTPCC_COM* CTPCC_COM_new(BOOL bSinglePool)
{
    return new CTPCC_COM(bSinglePool);
}

CTPCC_COM::CTPCC_COM(BOOL bSinglePool)
{
    HRESULT hr = NULL;
    long lRet = 0;
    ULONG ulTmpSize = 0;

    m_pTxn = NULL;
    m_pNewOrder = NULL;
    m_pPayment = NULL;
    m_pStockLevel = NULL;
    m_pOrderStatus = NULL;

    m_bSinglePool = bSinglePool;

    ulTmpSize = (ULONG) sizeof(COM_DATA);
    VariantInit(&m_vTxn);
    m_vTxn.vt = VT_SAFEARRAY;

    m_vTxn.parray = SafeArrayCreateVector(VT_UI1, ulTmpSize, ulTmpSize);
    if (!m_vTxn.parray)
        throw new CCOMERR( E_FAIL );

    memset((void*)m_vTxn.parray->pvData, 0, ulTmpSize);
    m_pTxn = (COM_DATA*)m_vTxn.parray->pvData;

    hr = CoInitializeEx(NULL, COINIT_MULTITHREADED);
    if (FAILED(hr))
    {
        throw new CCOMERR( hr );
    }

    // create components
    if (m_bSinglePool)
    {
        hr = CoCreateInstance(CLSID_TPCC, NULL, CLSCTX_SERVER, IID_ITPCC,
        (void **)&m_pNewOrder);
        if (FAILED(hr))
            throw new CCOMERR(hr);

        // all txns will use same component
        m_pPayment = m_pNewOrder;
        m_pStockLevel = m_pNewOrder;
        m_pOrderStatus = m_pNewOrder;
    }
    else
    {
        // use different components for each txn

        hr = CoCreateInstance(CLSID_NewOrder, NULL, CLSCTX_SERVER, IID_ITPCC,
        (void **)&m_pNewOrder);
        if (FAILED(hr))
            throw new CCOMERR(hr);

        hr = CoCreateInstance(CLSID_Payment, NULL, CLSCTX_SERVER, IID_ITPCC,
        (void **)&m_pPayment);
```

```
        if (FAILED(hr))
            throw new CCOMERR(hr);

        hr = CoCreateInstance(CLSID_StockLevel, NULL, CLSCTX_SERVER,
        IID_ITPCC, (void **)&m_pStockLevel);
        if (FAILED(hr))
            throw new CCOMERR(hr);

        hr = CoCreateInstance(CLSID_OrderStatus, NULL, CLSCTX_SERVER,
        IID_ITPCC, (void **)&m_pOrderStatus);
        if (FAILED(hr))
            throw new CCOMERR(hr);
    }

    // call setcomplete to release each component back into pool
    hr = m_pNewOrder->CallSetComplete();
    if (FAILED(hr))
        throw new CCOMERR(hr);

    if (!m_bSinglePool)
    {
        hr = m_pPayment->CallSetComplete();
        if (FAILED(hr))
            throw new CCOMERR(hr);

        hr = m_pStockLevel->CallSetComplete();
        if (FAILED(hr))
            throw new CCOMERR(hr);

        hr = m_pOrderStatus->CallSetComplete();
        if (FAILED(hr))
            throw new CCOMERR(hr);
    }
}

CTPCC_COM::~CTPCC_COM()
{
    if (m_pTxn)
        SafeArrayDestroy(m_vTxn.parray);

    ReleaseInterface(m_pNewOrder);
    if (!m_bSinglePool)
    {
        ReleaseInterface(m_pPayment);
        ReleaseInterface(m_pStockLevel);
        ReleaseInterface(m_pOrderStatus);
    }
    CoUninitialize();
}

void CTPCC_COM::NewOrder()
{
    VARIANT vTxn_out;

    HRESULT hr = m_pNewOrder->NewOrder(m_vTxn, &vTxn_out);
    if (FAILED(hr))
        throw new CCOMERR( hr );

    memcpy(m_pTxn, (void *)vTxn_out.parray->pvData, vTxn_out.parray->rgsabound[0].cElements);
    SafeArrayDestroy(vTxn_out.parray);

    if ( m_pTxn->ErrorType != ERR_SUCCESS )
        throw new CCOMERR( m_pTxn->ErrorType, m_pTxn->error );
```

Appendix A - Application Source Code

```
}
void CTPCC_COM::Payment()
{
    VARIANT vTxn_out;

    HRESULT hr = m_pPayment->Payment(m_vTxn, &vTxn_out);
    if (FAILED(hr))
        throw new CCOMERR( hr );
    memcpy(m_pTxn, (void *)vTxn_out.parray->pvData, vTxn_out.parray->rgsabound[0].cElements);
    SafeArrayDestroy(vTxn_out.parray);

    if ( m_pTxn->ErrorType != ERR_SUCCESS )
        throw new CCOMERR( m_pTxn->ErrorType, m_pTxn->error );
}

void CTPCC_COM::StockLevel()
{
    VARIANT vTxn_out;

    HRESULT hr = m_pStockLevel->StockLevel(m_vTxn, &vTxn_out);
    if (FAILED(hr))
        throw new CCOMERR( hr );
    memcpy(m_pTxn, (void *)vTxn_out.parray->pvData, vTxn_out.parray->rgsabound[0].cElements);
    SafeArrayDestroy(vTxn_out.parray);

    if ( m_pTxn->ErrorType != ERR_SUCCESS )
        throw new CCOMERR( m_pTxn->ErrorType, m_pTxn->error );
}

void CTPCC_COM::OrderStatus()
{
    VARIANT vTxn_out;

    HRESULT hr = m_pOrderStatus->OrderStatus(m_vTxn, &vTxn_out);
    if (FAILED(hr))
        throw new CCOMERR( hr );
    memcpy(m_pTxn, (void *)vTxn_out.parray->pvData, vTxn_out.parray->rgsabound[0].cElements);
    SafeArrayDestroy(vTxn_out.parray);

    if ( m_pTxn->ErrorType != ERR_SUCCESS )
        throw new CCOMERR( m_pTxn->ErrorType, m_pTxn->error );
}
```

tm_com_dll/src/tpcc_com.h

```
/* FILE: TPCC_COM.H
 * Microsoft TPC-C Kit Ver. 4.20.000
 * Copyright Microsoft, 1999
 * All Rights Reserved
 * not yet audited
 * PURPOSE: Header file for TPC-C COM+ class implementation.
 * Change history:
```

```
* 4.20.000 - first version
*/
#pragma once

#include <stdio.h>
#include "..\..\tpcc_com_ps\src\tpcc_com_ps.h"

// need to declare functions for import, unless define has already been created
// by the DLL's .cpp module for export.
#ifdef DllDecl
#define DllDecl __declspec( dllimport )
#endif

class CCOMERR : public CBaseErr
{
private:
    char m_szErrorText[64];

public:
    // use this interface for genuine COM errors
    CCOMERR( HRESULT hr )
    {
        m_hr = hr;
        m_iErrorType = 0;
        m_iError = 0;
    }

    // use this interface to impersonate a non-COM error type
    CCOMERR( int iErrorType, int iError )
    {
        m_iErrorType = iErrorType;
        m_iError = iError;
        m_hr = S_OK;
    }

    int m_hr;
    int m_iErrorType;
    int m_iError;

    // A CCOMERR class can impersonate another class, which happens if
    // the error // was not actually a COM Services error, but was simply transmitted
    // back via COM.
    int ErrorType()
    {
        if (m_iErrorType == 0)
            return ERR_TYPE_COM;
        else
            return m_iErrorType;
    }

    int ErrorNum() {return m_hr;}

    char *ErrorText()
    {
        if (m_hr == S_OK)
            sprintf( m_szErrorText, "Error: Class %d, error #
%d", m_iErrorType, m_iError );
        else
            sprintf( m_szErrorText, "Error: COM HRESULT %x",
m_hr );
        return m_szErrorText;
    }
}
```

Appendix A - Application Source Code

```
};
}

class DllDecl CTPCC_COM : public CTPCC_BASE
{
private:
    BOOL m_bSinglePool;

    // COM Interface pointers
    ITPCC* m_pNewOrder;
    ITPCC* m_pPayment;
    ITPCC* m_pStockLevel;
    ITPCC* m_pOrderStatus;

    struct COM_DATA
    {
        int ErrorType;
        int error;
        union
        {
            NEW_ORDER_DATA NewOrder;
            PAYMENT_DATA Payment;
            DELIVERY_DATA Delivery;
            STOCK_LEVEL_DATA StockLevel;
            ORDER_STATUS_DATA OrderStatus;
        } u;
    } *m_pTxn;

public:
    VARIANT m_vTxn;

    CTPCC_COM(BOOL bSinglePool);
    ~CTPCC_COM(void);

    inline PNEW_ORDER_DATA BuffAddr_NewOrder();
    { return &m_pTxn->u.NewOrder; };
    inline PPAYMENT_DATA BuffAddr_Payment();
    { return &m_pTxn->u.Payment; };
    inline PDELIVERY_DATA BuffAddr_Delivery();
    { return &m_pTxn->u.Delivery; };
    inline PSTOCK_LEVEL_DATA BuffAddr_StockLevel() { return
&m_pTxn->u.StockLevel; };
    inline PORDER_STATUS_DATA BuffAddr_OrderStatus() { return
&m_pTxn->u.OrderStatus; };

    void NewOrder ();
    void Payment ();
    void StockLevel ();
    void OrderStatus ();
    void Delivery () { throw new CCOMERR(E_NOTIMPL); }

// not supported
};

inline void ReleaseInterface(IUnknown *pUnk)
{
    if (pUnk)
    {
        pUnk->Release();
        pUnk = NULL;
    }
}
}
```

```
// wrapper routine for class constructor
extern "C" __declspec(dllexport) CTPCC_COM* CTPCC_COM_new(BOOL);

typedef CTPCC_COM* (TYPE_CTPCC_COM)(BOOL);
```

tpcc_com_all/src/methods.h

```
/* FILE: METHODS.H
 * Microsoft TPC-C Kit Ver. 4.20.000
 * Copyright Microsoft, 1999
 * All Rights Reserved
 *
 * not yet audited
 *
 * PURPOSE: Header file for COM components.
 *
 * Change history:
 * 4.20.000 - first version
 */
```

```
enum COMPONENT_ERROR
{
    ERR_MISSING_REGISTRY_ENTRIES = 1,
    ERR_LOADDLL_FAILED,
    ERR_GETPROCADDR_FAILED,
    ERR_UNKNOWN_DB_PROTOCOL
};

class CCOMPONENT_ERR : public CBaseErr
{
public:
    CCOMPONENT_ERR(COMPONENT_ERROR Err)
    {
        m_Error = Err;
        m_szTextDetail = NULL;
        m_SystemErr = 0;
        m_szErrorText = NULL;
    };

    CCOMPONENT_ERR(COMPONENT_ERROR Err, char
*szTextDetail, DWORD dwSystemErr)
    {
        m_Error = Err;
        m_szTextDetail = new
char[strlen(szTextDetail)+1];
    };
};
```

Appendix A - Application Source Code

```
        strcpy( m_szTextDetail, szTextDetail );
        m_SystemErr = dwSystemErr;
        m_szErrorText = NULL;
    };

~CCOMPONENT_ERR()
{
    if ( m_szTextDetail != NULL)
        delete [] m_szTextDetail;
    if ( m_szErrorText != NULL)
        delete [] m_szErrorText;
};

COMPONENT_ERROR      m_Error;
char                  *m_szTextDetail;
char                  *m_szErrorText;
DWORD                 m_SystemErr;

int ErrorType() {return ERR_TYPE_COMPONENT;};
int ErrorNum() {return m_Error;};
char *ErrorText();
};

static void WriteMessageToEventLog(LPTSTR lpszMsg);

////////////////////////////////////
////////////////////////////////////
// CTPCC_Common
class CTPCC_Common :
    public ITPCC,
    public IObjectControl,
    public IObjectConstruct,
    public CComObjectRootEx<CComSingleThreadModel>
{
public:
    BEGIN_COM_MAP(CTPCC_Common)
        COM_INTERFACE_ENTRY(ITPCC)
        COM_INTERFACE_ENTRY(IObjectControl)
        COM_INTERFACE_ENTRY(IObjectConstruct)
    END_COM_MAP()

    CTPCC_Common();
    ~CTPCC_Common();

// ITPCC
```

```
public:
    HRESULT __stdcall NewOrder(          VARIANT txn_in,
    VARIANT* txn_out);
    HRESULT __stdcall Payment(          VARIANT txn_in,
    VARIANT* txn_out);
    HRESULT __stdcall Delivery(         VARIANT txn_in,
    VARIANT* txn_out) {return E_NOTIMPL;};
    HRESULT __stdcall StockLevel(       VARIANT txn_in, VARIANT*
    txn_out);
    HRESULT __stdcall OrderStatus(      VARIANT txn_in,
    VARIANT* txn_out);

    HRESULT __stdcall CallSetComplete();

// IObjectControl
    STDMETHODCALLTYPE CanBePooled() { return m_bCanBePooled;
}
    STDMETHODCALLTYPE Activate() { return S_OK; } // we don't
support COM Services transactions (no enlistment)
    STDMETHODCALLTYPE Deactivate() { /* nothing to do */ }

// IObjectConstruct
    STDMETHODCALLTYPE Construct(IDispatch * pUnk);

// helper methods
private:
    BOOL            m_bCanBePooled;
    CTPCC_BASE     *m_pTxn;

    struct COM_DATA
    {
        int retval;
        int error;
        union
        {
            NEW_ORDER_DATA      NewOrder;
            PAYMENT_DATA         Payment;
            DELIVERY_DATA        Delivery;
            STOCK_LEVEL_DATA     StockLevel;
            ORDER_STATUS_DATA    OrderStatus;
        } u;
    };
};

////////////////////////////////////
////////////////////////////////////
```

Appendix A - Application Source Code

```
// CTPCC
class CTPCC :
    public CTPCC_Common,
    public CComCoClass<CTPCC, &CLSID_TPCC>
{
public:
DECLARE_REGISTRY_RESOURCEID(IDR_TPCC)

BEGIN_COM_MAP(CTPCC)
    COM_INTERFACE_ENTRY2(IUnknown, CComObjectRootEx)
    COM_INTERFACE_ENTRY_CHAIN(CTPCC_Common)
END_COM_MAP()

};

////////////////////////////////////
////////////////////////////////////
// CNewOrder
class CNewOrder :
    public CTPCC_Common,
    public CComCoClass<CNewOrder, &CLSID_NewOrder>
{
public:
DECLARE_REGISTRY_RESOURCEID(IDR_NEWORDER)

BEGIN_COM_MAP(CNewOrder)
    COM_INTERFACE_ENTRY2(IUnknown, CComObjectRootEx)
    COM_INTERFACE_ENTRY_CHAIN(CTPCC_Common)
END_COM_MAP()

// ITPCC
public:
// HRESULT __stdcall NewOrder(          VARIANT txn_in,
VARIANT* txn_out) {return E_NOTIMPL;}
    HRESULT __stdcall Payment(          VARIANT txn_in,
VARIANT* txn_out) {return E_NOTIMPL;}
    HRESULT __stdcall StockLevel( VARIANT txn_in, VARIANT*
txn_out) {return E_NOTIMPL;}
    HRESULT __stdcall OrderStatus(      VARIANT txn_in,
VARIANT* txn_out) {return E_NOTIMPL;}
};

////////////////////////////////////
////////////////////////////////////
// COrderStatus
```

```
class COrderStatus :
    public CTPCC_Common,
    public CComCoClass<COrderStatus, &CLSID_OrderStatus>
{
public:
DECLARE_REGISTRY_RESOURCEID(IDR_ORDERSTATUS)

BEGIN_COM_MAP(COrderStatus)
    COM_INTERFACE_ENTRY2(IUnknown, CComObjectRootEx)
    COM_INTERFACE_ENTRY_CHAIN(CTPCC_Common)
END_COM_MAP()

// ITPCC
public:
    HRESULT __stdcall NewOrder(          VARIANT txn_in,
VARIANT* txn_out) {return E_NOTIMPL;}
    HRESULT __stdcall Payment(          VARIANT txn_in,
VARIANT* txn_out) {return E_NOTIMPL;}
    HRESULT __stdcall StockLevel( VARIANT txn_in, VARIANT*
txn_out) {return E_NOTIMPL;}
// HRESULT __stdcall OrderStatus(      VARIANT txn_in,
VARIANT* txn_out) {return E_NOTIMPL;}
};

////////////////////////////////////
////////////////////////////////////
// CPayment
class CPayment :
    public CTPCC_Common,
    public CComCoClass<CPayment, &CLSID_Payment>
{
public:
DECLARE_REGISTRY_RESOURCEID(IDR_PAYMENT)

BEGIN_COM_MAP(CPayment)
    COM_INTERFACE_ENTRY2(IUnknown, CComObjectRootEx)
    COM_INTERFACE_ENTRY_CHAIN(CTPCC_Common)
END_COM_MAP()

// ITPCC
public:
    HRESULT __stdcall NewOrder(          VARIANT txn_in,
VARIANT* txn_out) {return E_NOTIMPL;}
// HRESULT __stdcall Payment(          VARIANT txn_in,
VARIANT* txn_out) {return E_NOTIMPL;}
};
```

Appendix A - Application Source Code

```
        HRESULT __stdcall StockLevel( VARIANT txn_in, VARIANT*
txn_out) {return E_NOTIMPL;}
        HRESULT __stdcall OrderStatus(          VARIANT txn_in,
VARIANT* txn_out) {return E_NOTIMPL;}
};

////////////////////////////////////
////////////////////////////////////
// CStockLevel
class CStockLevel :
    public CTPCC_Common,
    public CComCoClass<CStockLevel, &CLSID_StockLevel>
{
public:
DECLARE_REGISTRY_RESOURCEID( IDR_STOCKLEVEL)

BEGIN_COM_MAP(CStockLevel)
    COM_INTERFACE_ENTRY2(IUnknown, CComObjectRootEx)
    COM_INTERFACE_ENTRY_CHAIN(CTPCC_Common)
END_COM_MAP()

// ITPCC
public:
    HRESULT __stdcall NewOrder(          VARIANT txn_in,
VARIANT* txn_out) {return E_NOTIMPL;}
    HRESULT __stdcall Payment(          VARIANT txn_in,
VARIANT* txn_out) {return E_NOTIMPL;}
    // HRESULT __stdcall StockLevel( VARIANT txn_in, VARIANT*
txn_out) {return E_NOTIMPL;}
    HRESULT __stdcall OrderStatus(          VARIANT txn_in,
VARIANT* txn_out) {return E_NOTIMPL;}
};
```

tpcc_com_all/src/resource.h

```
///  
// Microsoft Developer Studio generated include file.  
// Used by tpcc_com_all.rc  
//  
#define IDS_PROJNAME                100  
#define IDR_TPCC                    101  
#define IDR_NEWORDER                102  
#define IDR_ORDERSTATUS             103  
#define IDR_PAYMENT                 104  
#define IDR_STOCKLEVEL              105
```

```
// Next default values for new objects  
//  
#ifdef APSTUDIO_INVOKED  
#ifndef APSTUDIO_READONLY_SYMBOLS  
#define _APS_NEXT_RESOURCE_VALUE        202  
#define _APS_NEXT_COMMAND_VALUE        32768  
#define _APS_NEXT_CONTROL_VALUE        201  
#define _APS_NEXT_SYMED_VALUE          106  
#endif  
#endif
```

tpcc_com_all/src/tpcc_com_all.cpp

```
/*      FILE:                TPC_C_COM_ALL.CPP  
 *      Microsoft TPC-C Kit Ver. 4.20.000  
 *      Copyright Microsoft, 1999  
 *  
 *      All Rights Reserved  
 *  
 *      Version 4.10.000 audited by Richard Gimarc,  
Performance Metrics, 3/17/99  
 *  
 *      PURPOSE:  Implementation for TPC-C Tuxedo class.  
 *      Contact:  Charles Levine (clevine@microsoft.com)  
 *  
 *      Change history:  
 *      4.20.000 - updated rev number to match kit  
 */  
  
#define STRICT  
#define _WIN32_WINNT 0x0400  
#define _ATL_APARTMENT_THREADED  
  
#include <stdio.h>  
#include <atlbase.h>  
//You may derive a class from CComModule and use it if you want to override  
//something, but do not change the name of _Module  
extern CComModule _Module;  
  
#include <atlcom.h>  
#include <initguid.h>  
#include <transact.h>  
#include <atlimpl.cpp>  
#include <comsvcs.h>  
  
#include <sqltypes.h>  
#include <sql.h>  
#include <sqlext.h>  
  
#include "tpcc_com_ps.h"  
#include "..\..\common\src\trans.h" //tpckit  
transaction header contains definations of structures specific to TPC-C  
#include "..\..\common\src\txn_base.h"  
#include "..\..\common\src\error.h"  
#include "..\..\common\src\ReadRegistry.h"  
#include "..\..\db_dblib_dll\src\tpcc_dblib.h" // DBLIB implementation of  
TPC-C txns  
#include "..\..\db_odbc_dll\src\tpcc_odbc.h" // ODBC implementation of  
TPC-C txns
```

Appendix A - Application Source Code

```
#include "resource.h"
#include "tpcc_com_all.h"
#include "tpcc_com_all_i.c"
#include "Methods.h"
#include "..\..\tpcc_com_ps\src\tpcc_com_ps_i.c"
#include "..\..\common\src\ReadRegistry.cpp"

CComModule _Module;

BEGIN_OBJECT_MAP(ObjectMap)
    OBJECT_ENTRY(CLSID_TPCC, CTPCC)
    OBJECT_ENTRY(CLSID_NewOrder, CNewOrder)
    OBJECT_ENTRY(CLSID_OrderStatus, COrderStatus)
    OBJECT_ENTRY(CLSID_Payment, CPayment)
    OBJECT_ENTRY(CLSID_StockLevel, CStockLevel)
END_OBJECT_MAP()

// configuration settings from registry
TPCCREGISTRYDATA Reg;
char szMyComputerName[MAX_COMPUTERNAME_LENGTH+1];

static HINSTANCE hLibInstanceDb = NULL;

TYPE_CTPCC_DBLIB *pCTPCC_DBLIB_new;
TYPE_CTPCC_ODBC *pCTPCC_ODBC_new;

////////////////////////////////////
// DLL Entry Point

extern "C"
BOOL WINAPI DllMain(HINSTANCE hInstance, DWORD dwReason, LPVOID /*lpReserved*/)
{
    char szDllName[128];

    try
    {
        if (dwReason == DLL_PROCESS_ATTACH)
        {
            _Module.Init(ObjectMap, hInstance);
            DisableThreadLibraryCalls(hInstance);

            DWORD dwSize = MAX_COMPUTERNAME_LENGTH+1;
            GetComputerName(szMyComputerName, &dwSize);
            szMyComputerName[dwSize] = 0;

            if ( ReadTPCCRegistrySettings( &Reg ) )
                throw new CCOMPONENT_ERR(
ERR_MISSING_REGISTRY_ENTRIES );

            if (Reg.eDB_Protocol == DBLIB)
            {
                strcpy( szDllName, Reg.szPath );
                strcat( szDllName, "tpcc_dblib.dll");
                hLibInstanceDb = LoadLibrary( szDllName );
                if (hLibInstanceDb == NULL)
                    throw new CCOMPONENT_ERR(
ERR_LOADDLL_FAILED, szDllName, GetLastError() );
            }

            // get function pointer to wrapper for class
            constructor
                pCTPCC_DBLIB_new = (TYPE_CTPCC_DBLIB*)
GetProcAddress(hLibInstanceDb, "CTPCC_DBLIB_new");
                if (pCTPCC_DBLIB_new == NULL)
                    throw new CCOMPONENT_ERR(
ERR_GETPROCADDR_FAILED, szDllName, GetLastError() );
            }
            else if (Reg.eDB_Protocol == ODBC)
            {
                strcpy( szDllName, Reg.szPath );
                strcat( szDllName, "tpcc_odbc.dll");
                hLibInstanceDb = LoadLibrary( szDllName );
                if (hLibInstanceDb == NULL)
                    throw new CCOMPONENT_ERR(
ERR_LOADDLL_FAILED, szDllName, GetLastError() );
            }

            // get function pointer to wrapper for class
            constructor
                pCTPCC_ODBC_new = (TYPE_CTPCC_ODBC*)
GetProcAddress(hLibInstanceDb, "CTPCC_ODBC_new");
                if (pCTPCC_ODBC_new == NULL)
                    throw new CCOMPONENT_ERR(
ERR_GETPROCADDR_FAILED, szDllName, GetLastError() );
            }
            else
                throw new CCOMPONENT_ERR( ERR_UNKNOWN_DB_PROTOCOL
);
        }
        else if (dwReason == DLL_PROCESS_DETACH)
            _Module.Term();
    }
    catch (CBaseErr *e)
    {
        WriteMessageToEventLog(e->ErrorText());
        delete e;
        return FALSE;
    }
    catch (...)
    {
        WriteMessageToEventLog(TEXT("Unhandled exception in object
DllMain"));
        return FALSE;
    }

    return TRUE; // OK
}

////////////////////////////////////
// Used to determine whether the DLL can be unloaded by OLE

STDAPI DllCanUnloadNow(void)
{
    return (_Module.GetLockCount()==0) ? S_OK : S_FALSE;
}

////////////////////////////////////
// Returns a class factory to create an object of the requested type

STDAPI DllGetClassObject(REFCLSID rclsid, REFIID riid, LPVOID* ppv)
{
    return _Module.GetClassObject(rclsid, riid, ppv);
}
```

```
pCTPCC_DBLIB_new = (TYPE_CTPCC_DBLIB*)
GetProcAddress(hLibInstanceDb, "CTPCC_DBLIB_new");
    if (pCTPCC_DBLIB_new == NULL)
        throw new CCOMPONENT_ERR(
ERR_GETPROCADDR_FAILED, szDllName, GetLastError() );
    }
    else if (Reg.eDB_Protocol == ODBC)
    {
        strcpy( szDllName, Reg.szPath );
        strcat( szDllName, "tpcc_odbc.dll");
        hLibInstanceDb = LoadLibrary( szDllName );
        if (hLibInstanceDb == NULL)
            throw new CCOMPONENT_ERR(
ERR_LOADDLL_FAILED, szDllName, GetLastError() );
    }

    // get function pointer to wrapper for class
    constructor
        pCTPCC_ODBC_new = (TYPE_CTPCC_ODBC*)
GetProcAddress(hLibInstanceDb, "CTPCC_ODBC_new");
        if (pCTPCC_ODBC_new == NULL)
            throw new CCOMPONENT_ERR(
ERR_GETPROCADDR_FAILED, szDllName, GetLastError() );
        }
        else
            throw new CCOMPONENT_ERR( ERR_UNKNOWN_DB_PROTOCOL
);
    }
    else if (dwReason == DLL_PROCESS_DETACH)
        _Module.Term();
}
catch (CBaseErr *e)
{
    WriteMessageToEventLog(e->ErrorText());
    delete e;
    return FALSE;
}
catch (...)
{
    WriteMessageToEventLog(TEXT("Unhandled exception in object
DllMain"));
    return FALSE;
}

return TRUE; // OK
}

////////////////////////////////////
// Used to determine whether the DLL can be unloaded by OLE

STDAPI DllCanUnloadNow(void)
{
    return (_Module.GetLockCount()==0) ? S_OK : S_FALSE;
}

////////////////////////////////////
// Returns a class factory to create an object of the requested type

STDAPI DllGetClassObject(REFCLSID rclsid, REFIID riid, LPVOID* ppv)
{
    return _Module.GetClassObject(rclsid, riid, ppv);
}
```

Appendix A - Application Source Code

```
////////////////////////////////////
// DllRegisterServer - Adds entries to the system registry

STDAPI DllRegisterServer(void)
{
    // registers object, typelib and all interfaces in typelib
    return _Module.RegisterServer(TRUE);
}

////////////////////////////////////
// DllUnregisterServer - Removes entries from the system registry

STDAPI DllUnregisterServer(void)
{
    _Module.UnregisterServer();
    return S_OK;
}

static void WriteMessageToEventLog(LPTSTR lpszMsg)
{
    TCHAR    szMsg[256];
    HANDLE   hEventSource;
    LPTSTR   lpszStrings[2];

    // Use event logging to log the error.
    //
    hEventSource = RegisterEventSource(NULL, TEXT("tpcc_com_all.dll"));

    _stprintf(szMsg, TEXT("Error in COM+ TPC-C Component: "));
    lpszStrings[0] = szMsg;
    lpszStrings[1] = lpszMsg;

    if (hEventSource != NULL)
    {
        ReportEvent(hEventSource, // handle of event source
            EVENTLOG_ERROR_TYPE, // event type
            0, // event category
            0, // event ID
            NULL, // current user's SID
            2, // strings in lpszStrings
            0, // no bytes of raw data
            (LPCTSTR *)lpszStrings, // array of error strings
            NULL); // no raw data

        (VOID) DeregisterEventSource(hEventSource);
    }
}

inline void ReleaseInterface(IUnknown *pUnk)
{
    if (pUnk)
    {
        pUnk->Release();
        pUnk = NULL;
    }
}

/* FUNCTION: CCOMPONENT_ERR::ErrorText
 *
 */

char* CCOMPONENT_ERR::ErrorText(void)
```

```
{
    static SERRORMSG errorMsgs[] =
    {
        { ERR_MISSING_REGISTRY_ENTRIES, "Required entries missing
from registry." },
        { ERR_LOADDLL_FAILED, "Load of DLL
failed. DLL=" },
        { ERR_GETPROCADDR_FAILED, "Could not map proc in DLL.
GetProcAddr error. DLL=" },
        { ERR_UNKNOWN_DB_PROTOCOL, "Unknown database protocol
specified in registry." },
        { 0, "" }
    };

    char szTmp[256];
    int i = 0;
    while (TRUE)
    {
        if (errorMsgs[i].szMsg[0] == 0)
        {
            strcpy( szTmp, "Unknown error number. " );
            break;
        }
        if (m_Error == errorMsgs[i].iError)
        {
            strcpy( szTmp, errorMsgs[i].szMsg );
            break;
        }
        i++;
    }

    if (m_szTextDetail)
        strcat( szTmp, m_szTextDetail );
    if (m_SystemErr)
        wsprintf( szTmp+strlen(szTmp), " Error=%d", m_SystemErr );

    m_szErrorText = new char[strlen(szTmp)+1];
    strcpy( m_szErrorText, szTmp );
    return m_szErrorText;
}

CTPCC_Common::CTPCC_Common()
{
    m_pTxn = NULL;
    m_bCanBePooled = TRUE;
}

CTPCC_Common::~CTPCC_Common()
{
    if (m_pTxn)
        delete m_pTxn;
}

HRESULT CTPCC_Common::CallSetComplete()
{
    IObjectContext* pObjectContext = NULL;

    // get our object context
```

Appendix A - Application Source Code

```
HRESULT hr = CoGetObjectContext( IID_IObjectContext, (void **)&pObjectContext
);
pObjectContext->SetComplete();
ReleaseInterface(pObjectContext);
return hr;
}
//
// called by the ctor activator
//
STDMETHODIMP CTPCC_Common::Construct(IDispatch * pUnk)
{
    // Code to access construction string, if needed later...
    // if (!pUnk)
    //     return E_UNEXPECTED;
    // IObjectConstructString * pString = NULL;
    // HRESULT hr = pUnk->QueryInterface(IID_IObjectConstructString, (void
**) &pString);
    // pString->Release();

    try
    {
        if (Reg.eDB_Protocol == ODBC)
            m_pTxn = pCTPCC_ODBC_new( Reg.szDbServer, Reg.szDbUser,
Reg.szDbPassword, szMyComputerName, Reg.szDbName );
        else if (Reg.eDB_Protocol == DBLIB)
            m_pTxn = pCTPCC_DBLIB_new( Reg.szDbServer, Reg.szDbUser,
Reg.szDbPassword, szMyComputerName, Reg.szDbName );
    }
    catch (CBaseErr *e)
    {
        WriteMessageToEventLog(e->ErrorText());
        delete e;
        return E_FAIL;
    }
    catch (...)
    {
        WriteMessageToEventLog(TEXT("Unhandled exception in object
::Construct"));
        return E_FAIL;
    }

    return S_OK;
}

HRESULT CTPCC_Common::NewOrder(VARIANT txn_in, VARIANT* txn_out)
{
    PNEW_ORDER_DATA    pNewOrder;
    COM_DATA            *pData;
    try
    {
        pData = (COM_DATA*)txn_in.parray->pvData;
        pNewOrder = m_pTxn->BuffAddr_NewOrder();

        memcpy(pNewOrder, &pData->u.NewOrder, sizeof(NEW_ORDER_DATA));

        m_pTxn->NewOrder();           // do the actual txn

        VariantInit(txn_out);
        txn_out->vt = VT_SAFEARRAY;
        txn_out->parray = SafeArrayCreateVector(VT_UI1,
txn_in.parray-
>rgsabound->cElements,
txn_in.parray-
>rgsabound->cElements);
        pData = (COM_DATA*) txn_out->parray->pvData;

        memcpy( &pData->u.NewOrder, pNewOrder, sizeof(NEW_ORDER_DATA));

        pData->retval = ERR_SUCCESS;
        pData->error = 0;
        return S_OK;
    }
    catch (CBaseErr *e)
    {
        // check for lost database connection; if yes, component is toast
        if ( ((e->ErrorType() == ERR_TYPE_DBLIB) && (e->ErrorNum() == 10005))
||
10054)) )
            ((e->ErrorType() == ERR_TYPE_ODBC) && (e->ErrorNum() ==
m_bCanBePooled = FALSE;

        pData->retval = e->ErrorType();
        pData->error = e->ErrorNum();
        delete e;
        return E_FAIL;
    }
    catch (...)
    {
        WriteMessageToEventLog(TEXT("Unhandled exception.));
        pData->retval = ERR_TYPE_LOGIC;
        pData->error = 0;
        m_bCanBePooled = FALSE;
        return E_FAIL;
    }
}

HRESULT CTPCC_Common::Payment(VARIANT txn_in, VARIANT* txn_out)
{
    PPAYMENT_DATA      pPayment;
    COM_DATA            *pData;
    try
    {
        pData = (COM_DATA*)txn_in.parray->pvData;
        pPayment = m_pTxn->BuffAddr_Payment();

        memcpy(pPayment, &pData->u.Payment, sizeof(PAYMENT_DATA));

        m_pTxn->Payment();           // do the actual txn

        VariantInit(txn_out);
        txn_out->vt = VT_SAFEARRAY;
        txn_out->parray = SafeArrayCreateVector( VT_UI1,
txn_in.parray-
>rgsabound->cElements,
txn_in.parray-
>rgsabound->cElements);
        pData = (COM_DATA*) txn_out->parray->pvData;

        memcpy( &pData->u.Payment, pPayment, sizeof(PAYMENT_DATA));

        pData->retval = ERR_SUCCESS;
        pData->error = 0;
        return S_OK;
    }
    catch (CBaseErr *e)
    {
        WriteMessageToEventLog(TEXT("Unhandled exception.));
        pData->retval = ERR_TYPE_LOGIC;
        pData->error = 0;
        m_bCanBePooled = FALSE;
        return E_FAIL;
    }
}
}
```

```
txn_in.parray-
>rgsabound->cElements);
        pData = (COM_DATA*) txn_out->parray->pvData;

        memcpy( &pData->u.NewOrder, pNewOrder, sizeof(NEW_ORDER_DATA));

        pData->retval = ERR_SUCCESS;
        pData->error = 0;
        return S_OK;
    }
    catch (CBaseErr *e)
    {
        // check for lost database connection; if yes, component is toast
        if ( ((e->ErrorType() == ERR_TYPE_DBLIB) && (e->ErrorNum() == 10005))
||
10054)) )
            ((e->ErrorType() == ERR_TYPE_ODBC) && (e->ErrorNum() ==
m_bCanBePooled = FALSE;

        pData->retval = e->ErrorType();
        pData->error = e->ErrorNum();
        delete e;
        return E_FAIL;
    }
    catch (...)
    {
        WriteMessageToEventLog(TEXT("Unhandled exception.));
        pData->retval = ERR_TYPE_LOGIC;
        pData->error = 0;
        m_bCanBePooled = FALSE;
        return E_FAIL;
    }
}

HRESULT CTPCC_Common::Payment(VARIANT txn_in, VARIANT* txn_out)
{
    PPAYMENT_DATA      pPayment;
    COM_DATA            *pData;
    try
    {
        pData = (COM_DATA*)txn_in.parray->pvData;
        pPayment = m_pTxn->BuffAddr_Payment();

        memcpy(pPayment, &pData->u.Payment, sizeof(PAYMENT_DATA));

        m_pTxn->Payment();           // do the actual txn

        VariantInit(txn_out);
        txn_out->vt = VT_SAFEARRAY;
        txn_out->parray = SafeArrayCreateVector( VT_UI1,
txn_in.parray-
>rgsabound->cElements,
txn_in.parray-
>rgsabound->cElements);
        pData = (COM_DATA*) txn_out->parray->pvData;

        memcpy( &pData->u.Payment, pPayment, sizeof(PAYMENT_DATA));

        pData->retval = ERR_SUCCESS;
        pData->error = 0;
        return S_OK;
    }
    catch (CBaseErr *e)
    {
        WriteMessageToEventLog(TEXT("Unhandled exception.));
        pData->retval = ERR_TYPE_LOGIC;
        pData->error = 0;
        m_bCanBePooled = FALSE;
        return E_FAIL;
    }
}
}
```

Appendix A - Application Source Code

```
{
    // check for lost database connection; if yes, component is toast
    if ( ((e->ErrorType() == ERR_TYPE_DBLIB) && (e->ErrorNum() == 10005))
||
10054)) )
        ((e->ErrorType() == ERR_TYPE_ODBC) && (e->ErrorNum() ==
            m_bCanBePooled = FALSE;

        pData->retval = e->ErrorType();
        pData->error = e->ErrorNum();
        delete e;
        return E_FAIL;
    }
    catch (...)
    {
        WriteMessageToEventLog(TEXT("Unhandled exception."));
        pData->retval = ERR_TYPE_LOGIC;
        pData->error = 0;
        m_bCanBePooled = FALSE;
        return E_FAIL;
    }
}

HRESULT CTPCC_Common::StockLevel(VARIANT txn_in, VARIANT* txn_out)
{
    PSTOCK_LEVEL_DATA  pStockLevel;
    COM_DATA            *pData;

    try
    {
        pData = (COM_DATA*)txn_in.parray->pvData;
        pStockLevel = m_pTxn->BuffAddr_StockLevel();

        memcpy(pStockLevel, &pData->u.StockLevel, sizeof(STOCK_LEVEL_DATA));
        m_pTxn->StockLevel();

        VariantInit(txn_out);
        txn_out->vt = VT_SAFEARRAY;
        txn_out->parray = SafeArrayCreateVector( VT_UI1,
            txn_in.parray-
>rgsabound->cElements,
            txn_in.parray-
>rgsabound->cElements);
        pData = (COM_DATA*)txn_out->parray->pvData;

        memcpy( &pData->u.StockLevel, pStockLevel, sizeof(STOCK_LEVEL_DATA));

        pData->retval = ERR_SUCCESS;
        pData->error = 0;
        return S_OK;
    }
    catch (CBaseErr *e)
    {
        // check for lost database connection; if yes, component is toast
        if ( ((e->ErrorType() == ERR_TYPE_DBLIB) && (e->ErrorNum() == 10005))
||
10054)) )
            ((e->ErrorType() == ERR_TYPE_ODBC) && (e->ErrorNum() ==
                m_bCanBePooled = FALSE;

                pData->retval = e->ErrorType();
                pData->error = e->ErrorNum();
                delete e;
                return E_FAIL;
            )
        }
    }
    catch (...)
    {
        WriteMessageToEventLog(TEXT("Unhandled exception."));
        pData->retval = ERR_TYPE_LOGIC;
        pData->error = 0;
        m_bCanBePooled = FALSE;
    }
}
```

```
        delete e;
        return E_FAIL;
    }
    catch (...)
    {
        WriteMessageToEventLog(TEXT("Unhandled exception."));
        pData->retval = ERR_TYPE_LOGIC;
        pData->error = 0;
        m_bCanBePooled = FALSE;
        return E_FAIL;
    }
}

HRESULT CTPCC_Common::OrderStatus(VARIANT txn_in, VARIANT* txn_out)
{
    PORDER_STATUS_DATA  pOrderStatus;
    COM_DATA            *pData;
    try
    {
        pData = (COM_DATA*)txn_in.parray->pvData;
        pOrderStatus = m_pTxn->BuffAddr_OrderStatus();

        memcpy(pOrderStatus, &pData->u.OrderStatus,
            sizeof(ORDER_STATUS_DATA));

        m_pTxn->OrderStatus();

        VariantInit(txn_out);
        txn_out->vt = VT_SAFEARRAY;
        txn_out->parray = SafeArrayCreateVector( VT_UI1,
            txn_in.parray-
>rgsabound->cElements,
            txn_in.parray-
>rgsabound->cElements);
        pData = (COM_DATA*)txn_out->parray->pvData;

        memcpy( &pData->u.OrderStatus, pOrderStatus,
            sizeof(ORDER_STATUS_DATA));

        pData->retval = ERR_SUCCESS;
        pData->error = 0;
        return S_OK;
    }
    catch (CBaseErr *e)
    {
        // check for lost database connection; if yes, component is toast
        if ( ((e->ErrorType() == ERR_TYPE_DBLIB) && (e->ErrorNum() == 10005))
||
10054)) )
            ((e->ErrorType() == ERR_TYPE_ODBC) && (e->ErrorNum() ==
                m_bCanBePooled = FALSE;

                pData->retval = e->ErrorType();
                pData->error = e->ErrorNum();
                delete e;
                return E_FAIL;
            )
        }
    }
    catch (...)
    {
        WriteMessageToEventLog(TEXT("Unhandled exception."));
        pData->retval = ERR_TYPE_LOGIC;
        pData->error = 0;
        m_bCanBePooled = FALSE;
    }
}
```

Appendix A - Application Source Code

```
        return E_FAIL;
    }
}
```

tpcc_com_all/src/tpcc_com_all.def

```
; tpcc_com_all.def : Declares the module parameters.

LIBRARY      "tpcc_com_all.dll"

EXPORTS
    DllCanUnloadNow      @1 PRIVATE
    DllGetClassObject    @2 PRIVATE
    DllRegisterServer    @3 PRIVATE
    DllUnregisterServer  @4 PRIVATE
```

tpcc_com_all/src/tpcc_com_all.h

```
#pragma warning( disable: 4049 ) /* more than 64k source lines */

/* this ALWAYS GENERATED file contains the definitions for the interfaces */

/* File created by MIDL compiler version 5.03.0280 */
/* at Sat Apr 08 16:40:18 2000 */
/* Compiler settings for .\src\tpcc_com_all.idl:
   Oicf (OptLev=12), Wl, Zp8, env=Win32 (32b run), ms_ext, c_ext
   error checks: allocation ref bounds_check enum stub_data
   VC __declspec() decoration level:
       __declspec(uuid()), __declspec(selectany), __declspec(novtable)
   DECLSPEC_UUID(), MIDL_INTERFACE()
*/
//@@MIDL_FILE_HEADING(  )

/* verify that the <rpcndr.h> version is high enough to compile this file*/
#ifndef __REQUIRED_RPCNDR_H_VERSION__
#define __REQUIRED_RPCNDR_H_VERSION__ 440
#endif

#include "rpc.h"
#include "rpcndr.h"

#ifndef __tpcc_com_all_h__
#define __tpcc_com_all_h__

/* Forward Declarations */

#ifndef __TPCC_FWD_DEFINED__
#define __TPCC_FWD_DEFINED__
```

```
#ifndef __cplusplus
typedef class TPCC TPCC;
#else
typedef struct TPCC TPCC;
#endif /* __cplusplus */

#endif /* __TPCC_FWD_DEFINED__ */

#ifndef __NewOrder_FWD_DEFINED__
#define __NewOrder_FWD_DEFINED__

#ifdef __cplusplus
typedef class NewOrder NewOrder;
#else
typedef struct NewOrder NewOrder;
#endif /* __cplusplus */

#endif /* __NewOrder_FWD_DEFINED__ */

#ifndef __OrderStatus_FWD_DEFINED__
#define __OrderStatus_FWD_DEFINED__

#ifdef __cplusplus
typedef class OrderStatus OrderStatus;
#else
typedef struct OrderStatus OrderStatus;
#endif /* __cplusplus */

#endif /* __OrderStatus_FWD_DEFINED__ */

#ifndef __Payment_FWD_DEFINED__
#define __Payment_FWD_DEFINED__

#ifdef __cplusplus
typedef class Payment Payment;
#else
typedef struct Payment Payment;
#endif /* __cplusplus */

#endif /* __Payment_FWD_DEFINED__ */

#ifndef __StockLevel_FWD_DEFINED__
#define __StockLevel_FWD_DEFINED__

#ifdef __cplusplus
typedef class StockLevel StockLevel;
#else
typedef struct StockLevel StockLevel;
#endif /* __cplusplus */

#endif /* __StockLevel_FWD_DEFINED__ */

/* header files for imported files */
#include "oaidl.h"
#include "ocidl.h"
#include "tpcc_com_ps.h"

#ifdef __cplusplus
```

Appendix A - Application Source Code

```
extern "C"{
#endif

void __RPC_FAR * __RPC_USER MIDL_user_allocate(size_t);
void __RPC_USER MIDL_user_free( void __RPC_FAR * );

/* interface __MIDL_itf_tpcc_com_all_0000 */
/* [local] */

extern RPC_IF_HANDLE __MIDL_itf_tpcc_com_all_0000_v0_0_c_ifspec;
extern RPC_IF_HANDLE __MIDL_itf_tpcc_com_all_0000_v0_0_s_ifspec;

#ifdef __TPCCLib_LIBRARY_DEFINED__
#define __TPCCLib_LIBRARY_DEFINED__

/* library TPCCLib */
/* [helpstring][version][uuid] */

EXTERN_C const IID LIBID_TPCCLib;

EXTERN_C const CLSID CLSID_TPCC;

#ifdef __cplusplus

class DECLSPEC_UUID("122A3128-2520-11D3-BA71-00C04FBFE08B")
TPCC;
#endif

EXTERN_C const CLSID CLSID_NewOrder;

#ifdef __cplusplus

class DECLSPEC_UUID("975BAABF-84A7-11D2-BA47-00C04FBFE08B")
NewOrder;
#endif

EXTERN_C const CLSID CLSID_OrderStatus;

#ifdef __cplusplus

class DECLSPEC_UUID("266836AD-A50D-11D2-BA4E-00C04FBFE08B")
OrderStatus;
#endif

EXTERN_C const CLSID CLSID_Payment;

#ifdef __cplusplus

class DECLSPEC_UUID("CD02F7EF-A4FA-11D2-BA4E-00C04FBFE08B")
Payment;
#endif

EXTERN_C const CLSID CLSID_StockLevel;
```

```
#ifdef __cplusplus

class DECLSPEC_UUID("2668369E-A50D-11D2-BA4E-00C04FBFE08B")
StockLevel;
#endif
#endif /* __TPCCLib_LIBRARY_DEFINED__ */

/* Additional Prototypes for ALL interfaces */

/* end of Additional Prototypes */

#ifdef __cplusplus
}
#endif

#endif
```

tpcc_com_all/src/tpcc_com_all.idl

```
/* FILE: TPCC.IDL
 * Microsoft TPC-C Kit Ver. 4.20.000
 * Copyright Microsoft, 1999
 * All Rights Reserved
 * not yet audited
 * PURPOSE: IDL source for TPCC.dll. This file is processed by the MIDL tool to
 * produce the type library (TPCC.tlb) and
 * marshalling code.
 * Change history:
 * 4.20.000 - first version
 */

interface TPCC;
interface NewOrder;
interface OrderStatus;
interface Payment;
interface StockLevel;

import "oidl.idl";
import "ocidl.idl";
import "..\tpcc_com_ps\src\tpcc_com_ps.idl";

[
    uuid(122A3117-2520-11D3-BA71-00C04FBFE08B),
    version(1.0),
    helpstring("TPC-C 1.0 Type Library")
]
library TPCCLib
{
    importlib("stdole32.tlb");
    importlib("stdole2.tlb");

    [
        uuid(122A3128-2520-11D3-BA71-00C04FBFE08B),
```

Appendix A - Application Source Code

```
        helpstring("All Txns Class")
    }
    coclass TPCC
    {
        [default] interface ITPCC;
    };

    [
        uuid(975BAABF-84A7-11D2-BA47-00C04FBFE08B),
        helpstring("NewOrder Class")
    ]
    coclass NewOrder
    {
        [default] interface ITPCC;
    };

    [
        uuid(266836AD-A50D-11D2-BA4E-00C04FBFE08B),
        helpstring("OrderStatus Class")
    ]
    coclass OrderStatus
    {
        [default] interface ITPCC;
    };

    [
        uuid(CD02F7EF-A4FA-11D2-BA4E-00C04FBFE08B),
        helpstring("Payment Class")
    ]
    coclass Payment
    {
        [default] interface ITPCC;
    };

    [
        uuid(2668369E-A50D-11D2-BA4E-00C04FBFE08B),
        helpstring("StockLevel Class")
    ]
    coclass StockLevel
    {
        [default] interface ITPCC;
    };
};
```

tpcc_com_all/src/tpcc_com_all.rc

```
//Microsoft Developer Studio generated resource script.
//
#include "resource.h"

#define APSTUDIO_READONLY_SYMBOLS
////////////////////////////////////
//
// Generated from the TEXTINCLUDE 2 resource.
```

```
//
#include "winres.h"

////////////////////////////////////
#undef APSTUDIO_READONLY_SYMBOLS

////////////////////////////////////
// English (U.S.) resources

#if !defined(AFX_RESOURCE_DLL) || defined(AFX_TARG_ENU)
#ifdef _WIN32
LANGUAGE LANG_ENGLISH, SUBLANG_ENGLISH_US
#pragma code_page(1252)
#endif // _WIN32

#ifdef APSTUDIO_INVOKED
////////////////////////////////////
//
// TEXTINCLUDE
//

1 TEXTINCLUDE DISCARDABLE
BEGIN
    "resource.h\0"
END

2 TEXTINCLUDE DISCARDABLE
BEGIN
    "#include \"winres.h\"\r\n"
    "\0"
END

3 TEXTINCLUDE DISCARDABLE
BEGIN
    "1 TYPELIB \"tpcc_com_all.tlb\"\r\n"
    "\0"
END

#endif // APSTUDIO_INVOKED

#ifdef _MAC
////////////////////////////////////
//
// Version
//

VS_VERSION_INFO VERSIONINFO
FILEVERSION 1,0,0,1
PRODUCTVERSION 1,0,0,1
FILEFLAGS 0x3fL
#ifdef _DEBUG
FILEFLAGS 0x1L
#else
FILEFLAGS 0x0L
#endif
FILEOS 0x4L
FILETYPE 0x2L
FILESUBTYPE 0x0L
BEGIN
    BLOCK "StringFileInfo"
    BEGIN
        BLOCK "040904B0"
```

Appendix A - Application Source Code

```
BEGIN
  VALUE "CompanyName", "\0"
  VALUE "FileDescription", "tpcc_com_all Module\0"
  VALUE "FileVersion", "1, 0, 0, 1\0"
  VALUE "InternalName", "TPCCNEWORDER\0"
  VALUE "LegalCopyright", "Copyright 1997\0"
  VALUE "OriginalFilename", "tpcc_com_all.DLL\0"
  VALUE "ProductName", "tpcc_com_all Module\0"
  VALUE "ProductVersion", "1, 0, 0, 1\0"
  VALUE "OLESelfRegister", "\0"
END
END
BLOCK "VarFileInfo"
BEGIN
  VALUE "Translation", 0x409, 1200
END
END

#endif // !_MAC

////////////////////////////////////
//
// REGISTRY
//

IDR_TPCC           REGISTRY DISCARDABLE "tpcc_com_all.rgs"
IDR_NEWORDER      REGISTRY DISCARDABLE "tpcc_com_no.rgs"
IDR_ORDERSTATUS   REGISTRY DISCARDABLE "tpcc_com_os.rgs"
IDR_PAYMENT       REGISTRY DISCARDABLE "tpcc_com_pay.rgs"
IDR_STOCKLEVEL    REGISTRY DISCARDABLE "tpcc_com_sl.rgs"

////////////////////////////////////
//
// String Table
//

STRINGTABLE DISCARDABLE
BEGIN
  IDS_PROJNAME      "tpcc_com_all"
END

#endif // English (U.S.) resources
////////////////////////////////////

#ifndef APSTUDIO_INVOKED
////////////////////////////////////
//
// Generated from the TEXTINCLUDE 3 resource.
//
1 TYPELIB "tpcc_com_all.tlb"
////////////////////////////////////
#endif // not APSTUDIO_INVOKED
```

tpcc_com_all/src/tpcc_com_all.rgs

```
HKCR
{
  TPCC.AllTxns.1 = s 'All Txns Class'
  {
    CLSID = s '{122A3128-2520-11D3-BA71-00C04FBFE08B}'
  }
  TPCC.AllTxns = s 'TPCC Class'
  {
    CurVer = s 'TPCC.AllTxns.1'
  }
  NoRemove CLSID
  {
    ForceRemove {122A3128-2520-11D3-BA71-00C04FBFE08B} = s 'TPCC Class'
    {
      ProgID = s 'TPCC.AllTxns.1'
      VersionIndependentProgID = s 'TPCC.AllTxns'
      InprocServer32 = s '%MODULE%'
      {
        val ThreadingModel = s 'Both'
      }
    }
  }
}
```

tpcc_com_all/src/tpcc_com_all_i.c

```
#pragma warning( disable: 4049 ) /* more than 64k source lines */

/* this ALWAYS GENERATED file contains the IIDs and CLSIDs */

/* link this file in with the server and any clients */

/* File created by MIDL compiler version 5.03.0280 */
/* at Sat Apr 08 16:40:18 2000
*/
/* Compiler settings for .\src\tpcc_com_all.idl:
  Oicf (OptLev=i2), Wl, Zp8, env=Win32 (32b run), ms_ext, c_ext
  error checks: allocation ref bounds_check enum stub_data
  VC __declspec() decoration level:
    __declspec(uuid()), __declspec(selectany), __declspec(novtable)
  DECLSPEC_UUID(), MIDL_INTERFACE()
*/
//@@MIDL_FILE_HEADING(  )

#ifdef _M_IA64 && !defined(_M_AXP64)

#ifdef __cplusplus
extern "C"{
#endif
```

Appendix A - Application Source Code

```
#include <rpc.h>
#include <rpcndr.h>

#ifdef _MIDL_USE_GUIDDEF_

#ifndef INITGUID
#define INITGUID
#include <guiddef.h>
#undef INITGUID
#else
#include <guiddef.h>
#endif

#define MIDL_DEFINE_GUID(type,name,l,w1,w2,b1,b2,b3,b4,b5,b6,b7,b8) \
    DEFINE_GUID(name,l,w1,w2,b1,b2,b3,b4,b5,b6,b7,b8)

#else // !_MIDL_USE_GUIDDEF_

#ifndef __IID_DEFINED__
#define __IID_DEFINED__

typedef struct _IID
{
    unsigned long x;
    unsigned short s1;
    unsigned short s2;
    unsigned char c[8];
} IID;

#endif // __IID_DEFINED__

#ifndef CLSID_DEFINED
#define CLSID_DEFINED
typedef IID CLSID;
#endif // CLSID_DEFINED

#define MIDL_DEFINE_GUID(type,name,l,w1,w2,b1,b2,b3,b4,b5,b6,b7,b8) \
    const type name = {l,w1,w2,{b1,b2,b3,b4,b5,b6,b7,b8}}

#endif !_MIDL_USE_GUIDDEF_

MIDL_DEFINE_GUID(IID,
LIBID_TPCCLib,0x122A3117,0x2520,0x11D3,0xBA,0x71,0x00,0xC0,0x4F,0xBF,0xE0,0x8B);

MIDL_DEFINE_GUID(CLSID,
CLSID_TPCC,0x122A3128,0x2520,0x11D3,0xBA,0x71,0x00,0xC0,0x4F,0xBF,0xE0,0x8B);

MIDL_DEFINE_GUID(CLSID,
CLSID_NewOrder,0x975BAABF,0x84A7,0x11D2,0xBA,0x47,0x00,0xC0,0x4F,0xBF,0xE0,0x8B);

MIDL_DEFINE_GUID(CLSID,
CLSID_OrderStatus,0x266836AD,0xA50D,0x11D2,0xBA,0x4E,0x00,0xC0,0x4F,0xBF,0xE0,0x8B);

MIDL_DEFINE_GUID(CLSID,
CLSID_Payment,0xCD02F7EF,0xA4FA,0x11D2,0xBA,0x4E,0x00,0xC0,0x4F,0xBF,0xE0,0x8B);
```

```
MIDL_DEFINE_GUID(CLSID,
CLSID_StockLevel,0x2668369E,0xA50D,0x11D2,0xBA,0x4E,0x00,0xC0,0x4F,0xBF,0xE0,0x8B);

#undef MIDL_DEFINE_GUID

#ifdef __cplusplus
}
#endif

#endif /* !defined(_M_IA64) && !defined(_M_AXP64) */

#pragma warning( disable: 4049 ) /* more than 64k source lines */

/* this ALWAYS GENERATED file contains the IIDs and CLSIDs */

/* link this file in with the server and any clients */

/* File created by MIDL compiler version 5.03.0280 */
/* at Sat Apr 08 16:40:18 2000
*/
/* Compiler settings for .\src\tpcc_com_all.idl:
    Oicf (OptLev=i2), Wl, Zp8, env=Win64 (32b run,appending), ms_ext, c_ext, robust
    error checks: allocation ref bounds_check enum stub_data
    VC __declspec() decoration level:
        __declspec(uuid()), __declspec(selectany), __declspec(novtable)
        DECLSPEC_UUID(), MIDL_INTERFACE()
*/
//@@MIDL_FILE_HEADING( )

#ifdef _M_IA64 || defined(_M_AXP64)

#ifdef __cplusplus
extern "C"{
#endif

#include <rpc.h>
#include <rpcndr.h>

#ifdef _MIDL_USE_GUIDDEF_

#ifndef INITGUID
#define INITGUID
#include <guiddef.h>
#undef INITGUID
#else
#include <guiddef.h>
#endif

#define MIDL_DEFINE_GUID(type,name,l,w1,w2,b1,b2,b3,b4,b5,b6,b7,b8) \
    DEFINE_GUID(name,l,w1,w2,b1,b2,b3,b4,b5,b6,b7,b8)

#else // !_MIDL_USE_GUIDDEF_

#ifndef __IID_DEFINED__
#define __IID_DEFINED__

typedef struct _IID
{
```

Appendix A - Application Source Code

```
    unsigned long x;
    unsigned short s1;
    unsigned short s2;
    unsigned char c[8];
} IID;

#endif // __IID_DEFINED__

#ifndef CLSID_DEFINED
#define CLSID_DEFINED
typedef IID CLSID;
#endif // CLSID_DEFINED

#define MIDL_DEFINE_GUID(type,name,l,w1,w2,b1,b2,b3,b4,b5,b6,b7,b8) \
    const type name = {l,w1,w2,{b1,b2,b3,b4,b5,b6,b7,b8}}

#endif !_MIDL_USE_GUIDDEF_

MIDL_DEFINE_GUID(IID,
LIBID_TPCCLib,0x122A3117,0x2520,0x11D3,0xBA,0x71,0x00,0xC0,0x4F,0xBF,0xE0,0x8B);

MIDL_DEFINE_GUID(CLSID,
CLSID_TPCC,0x122A3128,0x2520,0x11D3,0xBA,0x71,0x00,0xC0,0x4F,0xBF,0xE0,0x8B);

MIDL_DEFINE_GUID(CLSID,
CLSID_NewOrder,0x975BAABF,0x84A7,0x11D2,0xBA,0x47,0x00,0xC0,0x4F,0xBF,0xE0,0x8B);

MIDL_DEFINE_GUID(CLSID,
CLSID_OrderStatus,0x266836AD,0xA50D,0x11D2,0xBA,0x4E,0x00,0xC0,0x4F,0xBF,0xE0,0x8B);

MIDL_DEFINE_GUID(CLSID,
CLSID_Payment,0xCD02F7EF,0xA4FA,0x11D2,0xBA,0x4E,0x00,0xC0,0x4F,0xBF,0xE0,0x8B);

MIDL_DEFINE_GUID(CLSID,
CLSID_StockLevel,0x2668369E,0xA50D,0x11D2,0xBA,0x4E,0x00,0xC0,0x4F,0xBF,0xE0,0x8B);

#undef MIDL_DEFINE_GUID

#ifdef __cplusplus
}
#endif

#endif /* defined(_M_IA64) || defined(_M_AXP64)*/
```

tpcc_com_all/src/tpcc_com_no.rgs

HKCR

```
{
    TPCC.NewOrder.1 = s 'NewOrder Class'
    {
        CLSID = s '{975BAABF-84A7-11D2-BA47-00C04FBFE08B}'
    }
    TPCC.NewOrder = s 'NewOrder Class'
    {
        CurVer = s 'TPCC.NewOrder.1'
    }
    NoRemove CLSID
    {
        ForceRemove {975BAABF-84A7-11D2-BA47-00C04FBFE08B} = s 'NewOrder
    Class'
        {
            ProgID = s 'TPCC.NewOrder.1'
            VersionIndependentProgID = s 'TPCC.NewOrder'
            InprocServer32 = s '%MODULE%'
            {
                val ThreadingModel = s 'Both'
            }
        }
    }
}
```

tpcc_com_all/src/tpcc_com_os.rgs

```
HKCR
{
    TPCC.OrderStatus.1 = s 'OrderStatus Class'
    {
        CLSID = s '{266836AD-A50D-11D2-BA4E-00C04FBFE08B}'
    }
    TPCC.OrderStatus = s 'OrderStatus Class'
    {
        CurVer = s 'TPCC.OrderStatus.1'
    }
    NoRemove CLSID
    {
        ForceRemove {266836AD-A50D-11D2-BA4E-00C04FBFE08B} = s 'OrderStatus
    Class'
        {
            ProgID = s 'TPCC.OrderStatus.1'
            VersionIndependentProgID = s 'TPCC.OrderStatus'
            InprocServer32 = s '%MODULE%'
            {
                val ThreadingModel = s 'Both'
            }
        }
    }
}
```

tpcc_com_all/src/tpcc_com_pay.rgs

HKCR

```
{
    TPCC.Payment.1 = s 'Payment Class'
```

Appendix A - Application Source Code

```
{
    CLSID = s '{CD02F7EF-A4FA-11D2-BA4E-00C04FBFE08B}'
}
TPCC.Payment = s 'Payment Class'
{
    CurVer = s 'TPCC.Payment.1'
}
NoRemove CLSID
{
    ForceRemove {CD02F7EF-A4FA-11D2-BA4E-00C04FBFE08B} = s 'Payment
Class'
    {
        ProgID = s 'TPCC.Payment.1'
        VersionIndependentProgID = s 'TPCC.Payment'
        InprocServer32 = s '%MODULE%'
        {
            val ThreadingModel = s 'Both'
        }
    }
}
}
```

tpcc_com_all/src/tpcc_com_ps.h

```
#pragma warning( disable: 4049 ) /* more than 64k source lines */

/* this ALWAYS GENERATED file contains the definitions for the interfaces */

/* File created by MIDL compiler version 5.03.0280 */
/* at Sat Apr 08 16:40:10 2000 */
/*
/* Compiler settings for .\src\tpcc_com_ps.idl:
    Oicf (OptLev=i2), Wl, Zp8, env=Win32 (32b run), ms_ext, c_ext
    error checks: allocation ref bounds_check enum stub_data
    VC __declspec() decoration level:
        __declspec(uuid()), __declspec(selectany), __declspec(novtable)
        DECLSPEC_UUID(), MIDL_INTERFACE()
*/
//@@MIDL_FILE_HEADING(  )

/* verify that the <rpcndr.h> version is high enough to compile this file*/
#ifdef __REQUIRED_RPCNDR_H_VERSION__
#define __REQUIRED_RPCNDR_H_VERSION__ 440
#endif

#include "rpc.h"
#include "rpcndr.h"

#ifdef __RPCNDR_H_VERSION__
#error this stub requires an updated version of <rpcndr.h>
#endif // __RPCNDR_H_VERSION__

#ifdef COM_NO_WINDOWS_H
#include "windows.h"

```

```
#include "ole2.h"
#endif /*COM_NO_WINDOWS_H*/

#ifdef __tpcc_com_ps_h__
#define __tpcc_com_ps_h__

/* Forward Declarations */

#ifdef __ITPCC_FWD_DEFINED__
#define __ITPCC_FWD_DEFINED__
typedef interface ITPCC ITPCC;
#endif /* __ITPCC_FWD_DEFINED__ */

/* header files for imported files */
#include "oaidl.h"
#include "ocidl.h"

#ifdef __cplusplus
extern "C"{
#endif

void __RPC_FAR * __RPC_USER MIDL_user_allocate(size_t);
void __RPC_USER MIDL_user_free( void __RPC_FAR * );

/* interface __MIDL_itf_tpcc_com_ps_0000 */
/* [local] */

extern RPC_IF_HANDLE __MIDL_itf_tpcc_com_ps_0000_v0_0_c_ifspec;
extern RPC_IF_HANDLE __MIDL_itf_tpcc_com_ps_0000_v0_0_s_ifspec;

#ifdef __ITPCC_INTERFACE_DEFINED__
#define __ITPCC_INTERFACE_DEFINED__

/* interface ITPCC */
/* [unique][helpstring][uuid][oleautomation][object] */

EXTERN_C const IID IID_ITPCC;

#if defined(__cplusplus) && !defined(CINTERFACE)

MIDL_INTERFACE("FEEE6AA2-84B1-11d2-BA47-00C04FBFE08B")
ITPCC : public IUnknown
{
public:
    virtual HRESULT __stdcall NewOrder(
        /* [in] */ VARIANT txn_in,
        /* [out] */ VARIANT __RPC_FAR *txn_out) = 0;

    virtual HRESULT __stdcall Payment(
        /* [in] */ VARIANT txn_in,
        /* [out] */ VARIANT __RPC_FAR *txn_out) = 0;

    virtual HRESULT __stdcall Delivery(
        /* [in] */ VARIANT txn_in,
        /* [out] */ VARIANT __RPC_FAR *txn_out) = 0;

    virtual HRESULT __stdcall StockLevel(
        /* [in] */ VARIANT txn_in,

```

Appendix A - Application Source Code

```
    /* [out] */ VARIANT __RPC_FAR *txn_out) = 0;

virtual HRESULT __stdcall OrderStatus(
    /* [in] */ VARIANT txn_in,
    /* [out] */ VARIANT __RPC_FAR *txn_out) = 0;

virtual HRESULT __stdcall CallSetComplete( void) = 0;
};

#else /* C style interface */

typedef struct ITPCCVtbl
{
    BEGIN_INTERFACE

    HRESULT ( STDMETHODCALLTYPE __RPC_FAR *QueryInterface )(
        ITPCC __RPC_FAR * This,
        /* [in] */ REFIID riid,
        /* [iid_is][out] */ void __RPC_FAR *__RPC_FAR *ppvObject);

    ULONG ( STDMETHODCALLTYPE __RPC_FAR *AddRef )(
        ITPCC __RPC_FAR * This);

    ULONG ( STDMETHODCALLTYPE __RPC_FAR *Release )(
        ITPCC __RPC_FAR * This);

    HRESULT ( STDMETHODCALLTYPE __RPC_FAR *NewOrder )(
        ITPCC __RPC_FAR * This,
        /* [in] */ VARIANT txn_in,
        /* [out] */ VARIANT __RPC_FAR *txn_out);

    HRESULT ( STDMETHODCALLTYPE __RPC_FAR *Payment )(
        ITPCC __RPC_FAR * This,
        /* [in] */ VARIANT txn_in,
        /* [out] */ VARIANT __RPC_FAR *txn_out);

    HRESULT ( STDMETHODCALLTYPE __RPC_FAR *Delivery )(
        ITPCC __RPC_FAR * This,
        /* [in] */ VARIANT txn_in,
        /* [out] */ VARIANT __RPC_FAR *txn_out);

    HRESULT ( STDMETHODCALLTYPE __RPC_FAR *StockLevel )(
        ITPCC __RPC_FAR * This,
        /* [in] */ VARIANT txn_in,
        /* [out] */ VARIANT __RPC_FAR *txn_out);

    HRESULT ( STDMETHODCALLTYPE __RPC_FAR *OrderStatus )(
        ITPCC __RPC_FAR * This,
        /* [in] */ VARIANT txn_in,
        /* [out] */ VARIANT __RPC_FAR *txn_out);

    HRESULT ( STDMETHODCALLTYPE __RPC_FAR *CallSetComplete )(
        ITPCC __RPC_FAR * This);

    END_INTERFACE
} ITPCCVtbl;

interface ITPCC
{
    CONST_VTBL struct ITPCCVtbl __RPC_FAR *lpVtbl;
};
```

```
#ifdef COBJMACROS

#define ITPCC_QueryInterface(This,riid,ppvObject) \
    (This)->lpVtbl -> QueryInterface(This,riid,ppvObject)

#define ITPCC_AddRef(This) \
    (This)->lpVtbl -> AddRef(This)

#define ITPCC_Release(This) \
    (This)->lpVtbl -> Release(This)

#define ITPCC_NewOrder(This,txn_in,txn_out) \
    (This)->lpVtbl -> NewOrder(This,txn_in,txn_out)

#define ITPCC_Payment(This,txn_in,txn_out) \
    (This)->lpVtbl -> Payment(This,txn_in,txn_out)

#define ITPCC_Delivery(This,txn_in,txn_out) \
    (This)->lpVtbl -> Delivery(This,txn_in,txn_out)

#define ITPCC_StockLevel(This,txn_in,txn_out) \
    (This)->lpVtbl -> StockLevel(This,txn_in,txn_out)

#define ITPCC_OrderStatus(This,txn_in,txn_out) \
    (This)->lpVtbl -> OrderStatus(This,txn_in,txn_out)

#define ITPCC_CallSetComplete(This) \
    (This)->lpVtbl -> CallSetComplete(This)

#endif /* COBJMACROS */

#endif /* C style interface */

HRESULT __stdcall ITPCC_NewOrder_Proxy(
    ITPCC __RPC_FAR * This,
    /* [in] */ VARIANT txn_in,
    /* [out] */ VARIANT __RPC_FAR *txn_out);

void __RPC_STUB ITPCC_NewOrder_Stub(
    IRpcStubBuffer *This,
    IRpcChannelBuffer *_pRpcChannelBuffer,
    PRPC_MESSAGE _pRpcMessage,
    DWORD *_pdwStubPhase);

HRESULT __stdcall ITPCC_Payment_Proxy(
    ITPCC __RPC_FAR * This,
    /* [in] */ VARIANT txn_in,
    /* [out] */ VARIANT __RPC_FAR *txn_out);

void __RPC_STUB ITPCC_Payment_Stub(
    IRpcStubBuffer *This,
    IRpcChannelBuffer *_pRpcChannelBuffer,
    PRPC_MESSAGE _pRpcMessage,
```

Appendix A - Application Source Code

```
DWORD *_pdwStubPhase);

HRESULT __stdcall ITPCC_Delivery_Proxy(
    ITPCC __RPC_FAR * This,
    /* [in] */ VARIANT txn_in,
    /* [out] */ VARIANT __RPC_FAR *txn_out);

void __RPC_STUB ITPCC_Delivery_Stub(
    IRpcStubBuffer *This,
    IRpcChannelBuffer *_pRpcChannelBuffer,
    PRPC_MESSAGE _pRpcMessage,
    DWORD *_pdwStubPhase);

HRESULT __stdcall ITPCC_StockLevel_Proxy(
    ITPCC __RPC_FAR * This,
    /* [in] */ VARIANT txn_in,
    /* [out] */ VARIANT __RPC_FAR *txn_out);

void __RPC_STUB ITPCC_StockLevel_Stub(
    IRpcStubBuffer *This,
    IRpcChannelBuffer *_pRpcChannelBuffer,
    PRPC_MESSAGE _pRpcMessage,
    DWORD *_pdwStubPhase);

HRESULT __stdcall ITPCC_OrderStatus_Proxy(
    ITPCC __RPC_FAR * This,
    /* [in] */ VARIANT txn_in,
    /* [out] */ VARIANT __RPC_FAR *txn_out);

void __RPC_STUB ITPCC_OrderStatus_Stub(
    IRpcStubBuffer *This,
    IRpcChannelBuffer *_pRpcChannelBuffer,
    PRPC_MESSAGE _pRpcMessage,
    DWORD *_pdwStubPhase);

HRESULT __stdcall ITPCC_CallSetComplete_Proxy(
    ITPCC __RPC_FAR * This);

void __RPC_STUB ITPCC_CallSetComplete_Stub(
    IRpcStubBuffer *This,
    IRpcChannelBuffer *_pRpcChannelBuffer,
    PRPC_MESSAGE _pRpcMessage,
    DWORD *_pdwStubPhase);

#endif /* __ITPCC_INTERFACE_DEFINED__ */

/* Additional Prototypes for ALL interfaces */

unsigned long          __RPC_USER  VARIANT_UserSize(      unsigned long __RPC_FAR *,
unsigned long          , VARIANT __RPC_FAR * );
unsigned char __RPC_FAR * __RPC_USER  VARIANT_UserMarshal(  unsigned long __RPC_FAR *,
unsigned char __RPC_FAR *, VARIANT __RPC_FAR * );
```

```
unsigned char __RPC_FAR * __RPC_USER  VARIANT_UserUnmarshal(unsigned long __RPC_FAR *,
unsigned char __RPC_FAR *, VARIANT __RPC_FAR * );
void          __RPC_USER  VARIANT_UserFree(      unsigned long __RPC_FAR *,
VARIANT __RPC_FAR * );

/* end of Additional Prototypes */

#ifdef __cplusplus
}
#endif

#endif
```

tpcc_com_all/src/tpcc_com_sl.rgs

```
HKCR
{
    TPCC.StockLevel.1 = s 'StockLevel Class'
    {
        CLSID = s '{2668369E-A50D-11D2-BA4E-00C04FBFE08B}'
    }
    TPCC.StockLevel = s 'StockLevel Class'
    {
        CurVer = s 'TPCC.StockLevel.1'
    }
    NoRemove CLSID
    {
        ForceRemove {2668369E-A50D-11D2-BA4E-00C04FBFE08B} = s 'StockLevel
Class'
        {
            ProgID = s 'TPCC.StockLevel.1'
            VersionIndependentProgID = s 'TPCC.StockLevel'
            InprocServer32 = s '%MODULE%'
            {
                val ThreadingModel = s 'Both'
            }
        }
    }
}
```

tpcc_com_ps/src/dlldata.c

```
/******
DllData file -- generated by MIDL compiler

DO NOT ALTER THIS FILE

This file is regenerated by MIDL on every IDL file compile.

To completely reconstruct this file, delete it and rerun MIDL
on all the IDL files in this DLL, specifying this file for the
```

Appendix A - Application Source Code

```
    /dlldata command line option
*****
#include <rpcproxy.h>

#ifdef __cplusplus
extern "C" {
#endif

EXTERN_PROXY_FILE( tpcc_com_ps )

PROXYFILE_LIST_START
/* Start of list */
REFERENCE_PROXY_FILE( tpcc_com_ps ),
/* End of list */
PROXYFILE_LIST_END

DLLDATA_ROUTINES( aProxyFileList, GET_DLL_CLSID )

#ifdef __cplusplus
} /*extern "C" */
#endif

/* end of generated dlldata file */
```

tpcc_com_ps/src/tpcc_com_ps.def

```
LIBRARY      "tpcc_com_ps"

DESCRIPTION  'Proxy/Stub DLL'

EXPORTS
    DllGetClassObject      @1  PRIVATE
    DllCanUnloadNow        @2  PRIVATE
    GetProxyDllInfo        @3  PRIVATE
    DllRegisterServer      @4  PRIVATE
    DllUnregisterServer    @5  PRIVATE
```

tpcc_com_ps/src/tpcc_com_ps.h

```
#pragma warning( disable: 4049 ) /* more than 64k source lines */

/* this ALWAYS GENERATED file contains the definitions for the interfaces */

/* File created by MIDL compiler version 5.03.0280 */
/* at Sat Apr 08 16:40:10 2000
*/
```

```
/* Compiler settings for .\src\tpcc_com_ps.idl:
Oicf (OptLev=i2), Wl, Zp8, env=Win32 (32b run), ms_ext, c_ext
error checks: allocation ref bounds_check enum stub_data
VC __declspec() decoration level:
    __declspec(uuid()), __declspec(selectany), __declspec(novtable)
    DECLSPEC_UUID(), MIDL_INTERFACE()
*/
//@@MIDL_FILE_HEADING(  )

/* verify that the <rpcndr.h> version is high enough to compile this file*/
#ifdef __REQUIRED_RPCNDR_H_VERSION__
#define __REQUIRED_RPCNDR_H_VERSION__ 440
#endif

#include "rpc.h"
#include "rpcndr.h"

#ifdef __RPCNDR_H_VERSION__
#error this stub requires an updated version of <rpcndr.h>
#endif // __RPCNDR_H_VERSION__

#ifdef COM_NO_WINDOWS_H
#include "windows.h"
#include "ole2.h"
#endif /*COM_NO_WINDOWS_H*/

#ifdef __tpcc_com_ps_h__
#define __tpcc_com_ps_h__

/* Forward Declarations */

#ifdef __ITPCC_FWD_DEFINED__
#define __ITPCC_FWD_DEFINED__
typedef interface ITPCC ITPCC;
#endif /* __ITPCC_FWD_DEFINED__ */

/* header files for imported files */
#include "oaidl.h"
#include "ocidl.h"

#ifdef __cplusplus
extern "C"{
#endif

void __RPC_FAR * __RPC_USER MIDL_user_allocate(size_t);
void __RPC_USER MIDL_user_free( void __RPC_FAR * );

/* interface __MIDL_itf_tpcc_com_ps_0000 */
/* [local] */

extern RPC_IF_HANDLE __MIDL_itf_tpcc_com_ps_0000_v0_0_c_ifspec;
extern RPC_IF_HANDLE __MIDL_itf_tpcc_com_ps_0000_v0_0_s_ifspec;

#ifdef __ITPCC_INTERFACE_DEFINED__
#define __ITPCC_INTERFACE_DEFINED__

/* interface ITPCC */
/* [unique][helpstring][uuid][oleautomation][object] */
```

Appendix A - Application Source Code

```
EXTERN_C const IID IID_ITPCC;

#if defined(__cplusplus) && !defined(CINTERFACE)

MIDL_INTERFACE("FEEE6AA2-84B1-11d2-BA47-00C04FBFE08B")
ITPCC : public IUnknown
{
public:
    virtual HRESULT __stdcall NewOrder(
        /* [in] */ VARIANT txn_in,
        /* [out] */ VARIANT __RPC_FAR *txn_out) = 0;

    virtual HRESULT __stdcall Payment(
        /* [in] */ VARIANT txn_in,
        /* [out] */ VARIANT __RPC_FAR *txn_out) = 0;

    virtual HRESULT __stdcall Delivery(
        /* [in] */ VARIANT txn_in,
        /* [out] */ VARIANT __RPC_FAR *txn_out) = 0;

    virtual HRESULT __stdcall StockLevel(
        /* [in] */ VARIANT txn_in,
        /* [out] */ VARIANT __RPC_FAR *txn_out) = 0;

    virtual HRESULT __stdcall OrderStatus(
        /* [in] */ VARIANT txn_in,
        /* [out] */ VARIANT __RPC_FAR *txn_out) = 0;

    virtual HRESULT __stdcall CallSetComplete( void) = 0;

};

#else /* C style interface */

typedef struct ITPCCVtbl
{
    BEGIN_INTERFACE

    HRESULT ( STDMETHODCALLTYPE __RPC_FAR *QueryInterface )(
        ITPCC __RPC_FAR * This,
        /* [in] */ REFIID riid,
        /* [iid_is][out] */ void __RPC_FAR *__RPC_FAR *ppvObject);

    ULONG ( STDMETHODCALLTYPE __RPC_FAR *AddRef )(
        ITPCC __RPC_FAR * This);

    ULONG ( STDMETHODCALLTYPE __RPC_FAR *Release )(
        ITPCC __RPC_FAR * This);

    HRESULT ( STDMETHODCALLTYPE __RPC_FAR *NewOrder )(
        ITPCC __RPC_FAR * This,
        /* [in] */ VARIANT txn_in,
        /* [out] */ VARIANT __RPC_FAR *txn_out);

    HRESULT ( STDMETHODCALLTYPE __RPC_FAR *Payment )(
        ITPCC __RPC_FAR * This,
        /* [in] */ VARIANT txn_in,
        /* [out] */ VARIANT __RPC_FAR *txn_out);

    HRESULT ( STDMETHODCALLTYPE __RPC_FAR *Delivery )(
        ITPCC __RPC_FAR * This,
```

```
        /* [in] */ VARIANT txn_in,
        /* [out] */ VARIANT __RPC_FAR *txn_out);

    HRESULT ( STDMETHODCALLTYPE __RPC_FAR *StockLevel )(
        ITPCC __RPC_FAR * This,
        /* [in] */ VARIANT txn_in,
        /* [out] */ VARIANT __RPC_FAR *txn_out);

    HRESULT ( STDMETHODCALLTYPE __RPC_FAR *OrderStatus )(
        ITPCC __RPC_FAR * This,
        /* [in] */ VARIANT txn_in,
        /* [out] */ VARIANT __RPC_FAR *txn_out);

    HRESULT ( STDMETHODCALLTYPE __RPC_FAR *CallSetComplete )(
        ITPCC __RPC_FAR * This);

    END_INTERFACE
} ITPCCVtbl;

interface ITPCC
{
    CONST_VTBL struct ITPCCVtbl __RPC_FAR *lpVtbl;
};

#ifdef COBJMACROS

#define ITPCC_QueryInterface(This,riid,ppvObject) \
    (This)->lpVtbl -> QueryInterface(This,riid,ppvObject)

#define ITPCC_AddRef(This) \
    (This)->lpVtbl -> AddRef(This)

#define ITPCC_Release(This) \
    (This)->lpVtbl -> Release(This)

#define ITPCC_NewOrder(This,txn_in,txn_out) \
    (This)->lpVtbl -> NewOrder(This,txn_in,txn_out)

#define ITPCC_Payment(This,txn_in,txn_out) \
    (This)->lpVtbl -> Payment(This,txn_in,txn_out)

#define ITPCC_Delivery(This,txn_in,txn_out) \
    (This)->lpVtbl -> Delivery(This,txn_in,txn_out)

#define ITPCC_StockLevel(This,txn_in,txn_out) \
    (This)->lpVtbl -> StockLevel(This,txn_in,txn_out)

#define ITPCC_OrderStatus(This,txn_in,txn_out) \
    (This)->lpVtbl -> OrderStatus(This,txn_in,txn_out)

#define ITPCC_CallSetComplete(This) \
    (This)->lpVtbl -> CallSetComplete(This)

#endif /* COBJMACROS */

#endif /* C style interface */
```

Appendix A - Application Source Code

```
HRESULT __stdcall ITPCC_NewOrder_Proxy(
    ITPCC __RPC_FAR * This,
    /* [in] */ VARIANT txn_in,
    /* [out] */ VARIANT __RPC_FAR *txn_out);

void __RPC_STUB ITPCC_NewOrder_Stub(
    IrpcStubBuffer *This,
    IRpcChannelBuffer *pRpcChannelBuffer,
    PRPC_MESSAGE _pRpcMessage,
    DWORD *_pdwStubPhase);

HRESULT __stdcall ITPCC_Payment_Proxy(
    ITPCC __RPC_FAR * This,
    /* [in] */ VARIANT txn_in,
    /* [out] */ VARIANT __RPC_FAR *txn_out);

void __RPC_STUB ITPCC_Payment_Stub(
    IrpcStubBuffer *This,
    IRpcChannelBuffer *pRpcChannelBuffer,
    PRPC_MESSAGE _pRpcMessage,
    DWORD *_pdwStubPhase);

HRESULT __stdcall ITPCC_Delivery_Proxy(
    ITPCC __RPC_FAR * This,
    /* [in] */ VARIANT txn_in,
    /* [out] */ VARIANT __RPC_FAR *txn_out);

void __RPC_STUB ITPCC_Delivery_Stub(
    IrpcStubBuffer *This,
    IRpcChannelBuffer *pRpcChannelBuffer,
    PRPC_MESSAGE _pRpcMessage,
    DWORD *_pdwStubPhase);

HRESULT __stdcall ITPCC_StockLevel_Proxy(
    ITPCC __RPC_FAR * This,
    /* [in] */ VARIANT txn_in,
    /* [out] */ VARIANT __RPC_FAR *txn_out);

void __RPC_STUB ITPCC_StockLevel_Stub(
    IrpcStubBuffer *This,
    IRpcChannelBuffer *pRpcChannelBuffer,
    PRPC_MESSAGE _pRpcMessage,
    DWORD *_pdwStubPhase);

HRESULT __stdcall ITPCC_OrderStatus_Proxy(
    ITPCC __RPC_FAR * This,
    /* [in] */ VARIANT txn_in,
    /* [out] */ VARIANT __RPC_FAR *txn_out);

void __RPC_STUB ITPCC_OrderStatus_Stub(
    IrpcStubBuffer *This,
    IRpcChannelBuffer *pRpcChannelBuffer,
    PRPC_MESSAGE _pRpcMessage,
```

```
DWORD *_pdwStubPhase);

HRESULT __stdcall ITPCC_CallSetComplete_Proxy(
    ITPCC __RPC_FAR * This);

void __RPC_STUB ITPCC_CallSetComplete_Stub(
    IrpcStubBuffer *This,
    IRpcChannelBuffer *pRpcChannelBuffer,
    PRPC_MESSAGE _pRpcMessage,
    DWORD *_pdwStubPhase);

#endif /* __ITPCC_INTERFACE_DEFINED__ */

/* Additional Prototypes for ALL interfaces */

unsigned long             __RPC_USER  VARIANT_UserSize(      unsigned long __RPC_FAR *,
unsigned long             , VARIANT __RPC_FAR * );
unsigned char __RPC_FAR * __RPC_USER  VARIANT_UserMarshal(  unsigned long __RPC_FAR *,
unsigned char __RPC_FAR *, VARIANT __RPC_FAR * );
unsigned char __RPC_FAR * __RPC_USER  VARIANT_UserUnmarshal(unsigned long __RPC_FAR *,
unsigned char __RPC_FAR *, VARIANT __RPC_FAR * );
void                     __RPC_USER  VARIANT_UserFree(      unsigned long __RPC_FAR *,
VARIANT __RPC_FAR * );

/* end of Additional Prototypes */

#ifdef __cplusplus
}
#endif
#endif
```

tpcc_com_ps/src/tpcc_com_ps.idl

```
/*      FILE:          ITPCC.IDL
 *
 *                      Microsoft TPC-C Kit Ver. 4.20.000
 *                      Copyright Microsoft, 1999
 *
 *                      All Rights Reserved
 *
 *
 *                      not yet audited
 *
 *      PURPOSE:       Defines the interface used by TPCC. This
interface can be implemented by C++ components.
 *
 *      Change history:
 *                      4.20.000 - first version
```

Appendix A - Application Source Code

```
*/
// Forward declare all types defined
interface ITPCC;
import "oidl.idl";
import "ocidl.idl";

[
    object,
    oleautomation,
    uuid(FEEE6AA2-84B1-11d2-BA47-00C04FBFE08B),
    helpstring("ITPCC Interface"),
    pointer_default(unique)
]
interface ITPCC : IUnknown
{
    HRESULT STDMETHODCALLTYPE NewOrder
        (
            [in] VARIANT txn_in,
            [out] VARIANT *txn_out
        );

    HRESULT STDMETHODCALLTYPE Payment
        (
            [in] VARIANT txn_in,
            [out] VARIANT *txn_out
        );

    HRESULT STDMETHODCALLTYPE Delivery
        (
            [in] VARIANT txn_in,
            [out] VARIANT *txn_out
        );

    HRESULT STDMETHODCALLTYPE StockLevel
        (
            [in] VARIANT txn_in,
            [out] VARIANT *txn_out
        );

    HRESULT STDMETHODCALLTYPE OrderStatus
        (
            [in] VARIANT txn_in,
            [out] VARIANT *txn_out
        );
}
```

```
HRESULT STDMETHODCALLTYPE CallSetComplete
(
);

}; // interface ITPCC
```

tpcc_com_ps/src/tpcc_com_ps_i.c

```
#pragma warning( disable: 4049 ) /* more than 64k source lines */

/* this ALWAYS GENERATED file contains the IIDs and CLSIDs */

/* link this file in with the server and any clients */

/* File created by MIDL compiler version 5.03.0280 */
/* at Sat Apr 08 16:40:10 2000 */
*/
/* Compiler settings for .\src\tpcc_com_ps.idl:
   Oicf (OptLev=i2), Wl, Zp8, env=Win32 (32b run), ms_ext, c_ext
   error checks: allocation ref bounds_check enum stub_data
   VC __declspec() decoration level:
       __declspec(uuid()), __declspec(selectany), __declspec(novtable)
       DECLSPEC_UUID(), MIDL_INTERFACE()
*/
//@@MIDL_FILE_HEADING( )

#if !defined(_M_IA64) && !defined(_M_AXP64)

#ifdef __cplusplus
extern "C"{
#endif

#include <rpc.h>
#include <rpcndr.h>

#ifdef _MIDL_USE_GUIDDEF_

#ifndef INITGUID
#define INITGUID
#include <guiddef.h>
#undef INITGUID
#else
#include <guiddef.h>
#endif

#define MIDL_DEFINE_GUID(type,name,l,w1,w2,b1,b2,b3,b4,b5,b6,b7,b8) \
    DEFINE_GUID(name,l,w1,w2,b1,b2,b3,b4,b5,b6,b7,b8)

#else // !_MIDL_USE_GUIDDEF_
```

Appendix A - Application Source Code

```
#ifndef __IID_DEFINED__
#define __IID_DEFINED__

typedef struct _IID
{
    unsigned long x;
    unsigned short s1;
    unsigned short s2;
    unsigned char c[8];
} IID;

#endif // __IID_DEFINED__

#ifndef CLSID_DEFINED
#define CLSID_DEFINED
typedef IID CLSID;
#endif // CLSID_DEFINED

#define MIDL_DEFINE_GUID(type,name,l,w1,w2,b1,b2,b3,b4,b5,b6,b7,b8) \
    const type name = {l,w1,w2,{b1,b2,b3,b4,b5,b6,b7,b8}}

#endif !_MIDL_USE_GUIDDEF_

MIDL_DEFINE_GUID(IID,
IID_ITPCC,0xFEE66AA2,0x84B1,0x11d2,0xBA,0x47,0x00,0xC0,0x4F,0xBF,0xE0,0x8B);

#undef MIDL_DEFINE_GUID

#ifdef __cplusplus
}
#endif

#endif /* !defined(_M_IA64) && !defined(_M_AXP64)*/

#pragma warning( disable: 4049 ) /* more than 64k source lines */

/* this ALWAYS GENERATED file contains the IIDs and CLSIDs */

/* link this file in with the server and any clients */

/* File created by MIDL compiler version 5.03.0280 */
/* at Sat Apr 08 16:40:10 2000 */
/*
/* Compiler settings for .\src\tpcc_com_ps.idl:
    Oicf (OptLev=i2), Wl, Zp8, env=Win64 (32b run,appending), ms_ext, c_ext, robust
    error checks: allocation ref bounds_check enum stub_data
    VC __declspec() decoration level:
        __declspec(uuid()), __declspec(selectany), __declspec(novtable)
        DECLSPEC_UUID(), MIDL_INTERFACE()
*/
//@@MIDL_FILE_HEADING( )

#ifdef defined(_M_IA64) || defined(_M_AXP64)

#ifdef __cplusplus
extern "C"{
#endif
#endif
```

```
#include <rpc.h>
#include <rpcndr.h>

#ifdef _MIDL_USE_GUIDDEF_

#ifndef INITGUID
#define INITGUID
#include <guiddef.h>
#undef INITGUID
#else
#include <guiddef.h>
#endif

#define MIDL_DEFINE_GUID(type,name,l,w1,w2,b1,b2,b3,b4,b5,b6,b7,b8) \
    DEFINE_GUID(name,l,w1,w2,b1,b2,b3,b4,b5,b6,b7,b8)

#else // !_MIDL_USE_GUIDDEF_

#ifndef __IID_DEFINED__
#define __IID_DEFINED__

typedef struct _IID
{
    unsigned long x;
    unsigned short s1;
    unsigned short s2;
    unsigned char c[8];
} IID;

#endif // __IID_DEFINED__

#ifndef CLSID_DEFINED
#define CLSID_DEFINED
typedef IID CLSID;
#endif // CLSID_DEFINED

#define MIDL_DEFINE_GUID(type,name,l,w1,w2,b1,b2,b3,b4,b5,b6,b7,b8) \
    const type name = {l,w1,w2,{b1,b2,b3,b4,b5,b6,b7,b8}}

#endif !_MIDL_USE_GUIDDEF_

MIDL_DEFINE_GUID(IID,
IID_ITPCC,0xFEE66AA2,0x84B1,0x11d2,0xBA,0x47,0x00,0xC0,0x4F,0xBF,0xE0,0x8B);

#undef MIDL_DEFINE_GUID

#ifdef __cplusplus
}
#endif

#endif /* defined(_M_IA64) || defined(_M_AXP64)*/
```

tpcc_com_ps/src/tpcc_com_ps_p.c

Appendix A - Application Source Code

```
#pragma warning( disable: 4049 ) /* more than 64k source lines */

/* this ALWAYS GENERATED file contains the proxy stub code */

/* File created by MIDL compiler version 5.03.0280 */
/* at Sat Apr 08 16:40:10 2000
*/
/* Compiler settings for .\src\tpcc_com_ps.idl:
Oicf (OptLev=i2), Wl, Zp8, env=Win32 (32b run), ms_ext, c_ext
error checks: allocation ref bounds_check enum stub_data
VC __declspec() decoration level:
__declspec(uuid()), __declspec(selectany), __declspec(novtable)
DECLSPEC_UUID(), MIDL_INTERFACE()
*/
//@@MIDL_FILE_HEADING( )

#if !defined(_M_IA64) && !defined(_M_AXP64)
#define USE_STUBLESS_PROXY

/* verify that the <rpcproxy.h> version is high enough to compile this file*/
#ifdef __REDQ_RPCPROXY_H_VERSION__
#define __REQUIRED_RPCPROXY_H_VERSION__ 440
#endif

#include "rpcproxy.h"
#ifdef __RPCPROXY_H_VERSION__
#error this stub requires an updated version of <rpcproxy.h>
#endif // __RPCPROXY_H_VERSION__

#include "tpcc_com_ps.h"

#define TYPE_FORMAT_STRING_SIZE 997
#define PROC_FORMAT_STRING_SIZE 193
#define TRANSMIT_AS_TABLE_SIZE 0
#define WIRE_MARSHAL_TABLE_SIZE 1

typedef struct _MIDL_TYPE_FORMAT_STRING
{
    short Pad;
    unsigned char Format[ TYPE_FORMAT_STRING_SIZE ];
} MIDL_TYPE_FORMAT_STRING;

typedef struct _MIDL_PROC_FORMAT_STRING
{
    short Pad;
    unsigned char Format[ PROC_FORMAT_STRING_SIZE ];
} MIDL_PROC_FORMAT_STRING;

extern const MIDL_TYPE_FORMAT_STRING __MIDL_TypeFormatString;
extern const MIDL_PROC_FORMAT_STRING __MIDL_ProcFormatString;

/* Standard interface: __MIDL_itf_tpcc_com_ps_0000, ver. 0.0,
GUID={0x00000000,0x0000,0x0000,{0x00,0x00,0x00,0x00,0x00,0x00,0x00,0x00}} */
```

```
/* Object interface: IUnknown, ver. 0.0,
GUID={0x00000000,0x0000,0x0000,{0xC0,0x00,0x00,0x00,0x00,0x00,0x00,0x46}} */

/* Object interface: ITPCC, ver. 0.0,
GUID={0xFEE6AA2,0x84B1,0x11d2,{0xBA,0x47,0x00,0xC0,0x4F,0xBF,0xE0,0x8B}} */

extern const MIDL_STUB_DESC Object_StubDesc;

extern const MIDL_SERVER_INFO ITPCC_ServerInfo;

#pragma code_seg(".orpc")
static const unsigned short ITPCC_FormatStringOffsetTable[] =
{
    0,
    34,
    68,
    102,
    136,
    170
};

static const MIDL_SERVER_INFO ITPCC_ServerInfo =
{
    &Object_StubDesc,
    0,
    __MIDL_ProcFormatString.Format,
    &ITPCC_FormatStringOffsetTable[-3],
    0,
    0,
    0,
    0
};

static const MIDL_STUBLESS_PROXY_INFO ITPCC_ProxyInfo =
{
    &Object_StubDesc,
    __MIDL_ProcFormatString.Format,
    &ITPCC_FormatStringOffsetTable[-3],
    0,
    0,
    0
};

CINTERFACE_PROXY_VTABLE(9) _ITPCCProxyVtbl =
{
    &ITPCC_ProxyInfo,
    &IID_ITPCC,
    IUnknown_QueryInterface_Proxy,
    IUnknown_AddRef_Proxy,
    IUnknown_Release_Proxy ,
    (void *)-1 /* ITPCC::NewOrder */ ,
    (void *)-1 /* ITPCC::Payment */ ,
    (void *)-1 /* ITPCC::Delivery */ ,
    (void *)-1 /* ITPCC::StockLevel */ ,
    (void *)-1 /* ITPCC::OrderStatus */ ,
    (void *)-1 /* ITPCC::CallSetComplete */
};

const CInterfaceStubVtbl _ITPCCStubVtbl =
{
```

Appendix A - Application Source Code

```

                                NdrFcShort( 0x18 ), /* Alpha Stack size/offset = 24 */
#endif
/* 26 */ NdrFcShort( 0x3da ), /* Type Offset=986 */

/* Return value */

/* 28 */ NdrFcShort( 0x70 ), /* Flags: out, return, base type, */
#ifndef _ALPHA_
#ifndef _PPC_
#if !defined(_MIPS_)
/* 30 */ NdrFcShort( 0x18 ), /* x86 Stack size/offset = 24 */
#else
                                NdrFcShort( 0x1c ), /* MIPS Stack size/offset = 28 */
#endif
#else
                                NdrFcShort( 0x1c ), /* PPC Stack size/offset = 28 */
#endif
#else
                                NdrFcShort( 0x20 ), /* Alpha Stack size/offset = 32 */
#endif
/* 32 */ 0x8, /* FC_LONG */
0x0, /* 0 */

/* Procedure Payment */

/* 34 */ 0x33, /* FC_AUTO_HANDLE */
0x6c, /* Old Flags: object, Oi2 */
/* 36 */ NdrFcLong( 0x0 ), /* 0 */
/* 40 */ NdrFcShort( 0x4 ), /* 4 */
#ifndef _ALPHA_
#ifndef _PPC_
#if !defined(_MIPS_)
/* 42 */ NdrFcShort( 0x1c ), /* x86 Stack size/offset = 28 */
#else
                                NdrFcShort( 0x20 ), /* MIPS Stack size/offset = 32 */
#endif
#else
                                NdrFcShort( 0x20 ), /* PPC Stack size/offset = 32 */
#endif
#else
                                NdrFcShort( 0x28 ), /* Alpha Stack size/offset = 40 */
#endif
/* 44 */ NdrFcShort( 0x0 ), /* 0 */
/* 46 */ NdrFcShort( 0x8 ), /* 8 */
/* 48 */ 0x7, /* Oi2 Flags: srv must size, clt must size, has return, */
0x3, /* 3 */

/* Parameter txn_in */

/* 50 */ NdrFcShort( 0x8b ), /* Flags: must size, must free, in, by val, */
#ifndef _ALPHA_
#ifndef _PPC_
#if !defined(_MIPS_)
/* 52 */ NdrFcShort( 0x4 ), /* x86 Stack size/offset = 4 */
#else
                                NdrFcShort( 0x8 ), /* MIPS Stack size/offset = 8 */
#endif
#else
                                NdrFcShort( 0x8 ), /* PPC Stack size/offset = 8 */
#endif
#else
                                NdrFcShort( 0x8 ), /* Alpha Stack size/offset = 8 */
#endif
#endif
```

```

/* 54 */ NdrFcShort( 0x3c8 ), /* Type Offset=968 */

/* Parameter txn_out */

/* 56 */ NdrFcShort( 0x4113 ), /* Flags: must size, must free, out, simple ref,
srv alloc size=16 */
#ifndef _ALPHA_
#ifndef _PPC_
#if !defined(_MIPS_)
/* 58 */ NdrFcShort( 0x14 ), /* x86 Stack size/offset = 20 */
#else
                                NdrFcShort( 0x18 ), /* MIPS Stack size/offset = 24 */
#endif
#else
                                NdrFcShort( 0x18 ), /* PPC Stack size/offset = 24 */
#endif
#else
                                NdrFcShort( 0x18 ), /* Alpha Stack size/offset = 24 */
#endif
/* 60 */ NdrFcShort( 0x3da ), /* Type Offset=986 */

/* Return value */

/* 62 */ NdrFcShort( 0x70 ), /* Flags: out, return, base type, */
#ifndef _ALPHA_
#ifndef _PPC_
#if !defined(_MIPS_)
/* 64 */ NdrFcShort( 0x18 ), /* x86 Stack size/offset = 24 */
#else
                                NdrFcShort( 0x1c ), /* MIPS Stack size/offset = 28 */
#endif
#else
                                NdrFcShort( 0x1c ), /* PPC Stack size/offset = 28 */
#endif
#else
                                NdrFcShort( 0x20 ), /* Alpha Stack size/offset = 32 */
#endif
/* 66 */ 0x8, /* FC_LONG */
0x0, /* 0 */

/* Procedure Delivery */

/* 68 */ 0x33, /* FC_AUTO_HANDLE */
0x6c, /* Old Flags: object, Oi2 */
/* 70 */ NdrFcLong( 0x0 ), /* 0 */
/* 74 */ NdrFcShort( 0x5 ), /* 5 */
#ifndef _ALPHA_
#ifndef _PPC_
#if !defined(_MIPS_)
/* 76 */ NdrFcShort( 0x1c ), /* x86 Stack size/offset = 28 */
#else
                                NdrFcShort( 0x20 ), /* MIPS Stack size/offset = 32 */
#endif
#else
                                NdrFcShort( 0x20 ), /* PPC Stack size/offset = 32 */
#endif
#else
                                NdrFcShort( 0x28 ), /* Alpha Stack size/offset = 40 */
#endif
/* 78 */ NdrFcShort( 0x0 ), /* 0 */
/* 80 */ NdrFcShort( 0x8 ), /* 8 */
/* 82 */ 0x7, /* Oi2 Flags: srv must size, clt must size, has return, */
0x3, /* 3 */
```

Appendix A - Application Source Code

```
/* Parameter txn_in */

/* 84 */ NdrFcShort( 0x8b ), /* Flags: must size, must free, in, by val, */
#ifdef _ALPHA_
#ifdef _PPC_
#if !defined(_MIPS_)
/* 86 */ NdrFcShort( 0x4 ), /* x86 Stack size/offset = 4 */
#else
NdrFcShort( 0x8 ), /* MIPS Stack size/offset = 8 */
#endif
#else
NdrFcShort( 0x8 ), /* PPC Stack size/offset = 8 */
#endif
#else
NdrFcShort( 0x8 ), /* Alpha Stack size/offset = 8 */
#endif
/* 88 */ NdrFcShort( 0x3c8 ), /* Type Offset=968 */

/* Parameter txn_out */

/* 90 */ NdrFcShort( 0x4113 ), /* Flags: must size, must free, out, simple ref,
srv alloc size=16 */
#ifdef _ALPHA_
#ifdef _PPC_
#if !defined(_MIPS_)
/* 92 */ NdrFcShort( 0x14 ), /* x86 Stack size/offset = 20 */
#else
NdrFcShort( 0x18 ), /* MIPS Stack size/offset = 24 */
#endif
#else
NdrFcShort( 0x18 ), /* PPC Stack size/offset = 24 */
#endif
#else
NdrFcShort( 0x18 ), /* Alpha Stack size/offset = 24 */
#endif
/* 94 */ NdrFcShort( 0x3da ), /* Type Offset=986 */

/* Return value */

/* 96 */ NdrFcShort( 0x70 ), /* Flags: out, return, base type, */
#ifdef _ALPHA_
#ifdef _PPC_
#if !defined(_MIPS_)
/* 98 */ NdrFcShort( 0x18 ), /* x86 Stack size/offset = 24 */
#else
NdrFcShort( 0x1c ), /* MIPS Stack size/offset = 28 */
#endif
#else
NdrFcShort( 0x1c ), /* PPC Stack size/offset = 28 */
#endif
#else
NdrFcShort( 0x20 ), /* Alpha Stack size/offset = 32 */
#endif
/* 100 */ 0x8, /* FC_LONG */
0x0, /* 0 */

/* Procedure StockLevel */

/* 102 */ 0x33, /* FC_AUTO_HANDLE */
0x6c, /* Old Flags: object, Oi2 */
/* 104 */ NdrFcLong( 0x0 ), /* 0 */
/* 108 */ NdrFcShort( 0x6 ), /* 6 */
```

```
#ifndef _ALPHA_
#ifdef _PPC_
#if !defined(_MIPS_)
/* 110 */ NdrFcShort( 0x1c ), /* x86 Stack size/offset = 28 */
#else
NdrFcShort( 0x20 ), /* MIPS Stack size/offset = 32 */
#endif
#else
NdrFcShort( 0x20 ), /* PPC Stack size/offset = 32 */
#endif
#else
NdrFcShort( 0x28 ), /* Alpha Stack size/offset = 40 */
#endif
/* 112 */ NdrFcShort( 0x0 ), /* 0 */
/* 114 */ NdrFcShort( 0x8 ), /* 8 */
/* 116 */ 0x7, /* Oi2 Flags: srv must size, clt must size, has return, */
0x3, /* 3 */

/* Parameter txn_in */

/* 118 */ NdrFcShort( 0x8b ), /* Flags: must size, must free, in, by val, */
#ifdef _ALPHA_
#ifdef _PPC_
#if !defined(_MIPS_)
/* 120 */ NdrFcShort( 0x4 ), /* x86 Stack size/offset = 4 */
#else
NdrFcShort( 0x8 ), /* MIPS Stack size/offset = 8 */
#endif
#else
NdrFcShort( 0x8 ), /* PPC Stack size/offset = 8 */
#endif
#else
NdrFcShort( 0x8 ), /* Alpha Stack size/offset = 8 */
#endif
/* 122 */ NdrFcShort( 0x3c8 ), /* Type Offset=968 */

/* Parameter txn_out */

/* 124 */ NdrFcShort( 0x4113 ), /* Flags: must size, must free, out, simple ref,
srv alloc size=16 */
#ifdef _ALPHA_
#ifdef _PPC_
#if !defined(_MIPS_)
/* 126 */ NdrFcShort( 0x14 ), /* x86 Stack size/offset = 20 */
#else
NdrFcShort( 0x18 ), /* MIPS Stack size/offset = 24 */
#endif
#else
NdrFcShort( 0x18 ), /* PPC Stack size/offset = 24 */
#endif
#else
NdrFcShort( 0x18 ), /* Alpha Stack size/offset = 24 */
#endif
/* 128 */ NdrFcShort( 0x3da ), /* Type Offset=986 */

/* Return value */

/* 130 */ NdrFcShort( 0x70 ), /* Flags: out, return, base type, */
#ifdef _ALPHA_
#ifdef _PPC_
#if !defined(_MIPS_)
/* 132 */ NdrFcShort( 0x18 ), /* x86 Stack size/offset = 24 */
#else
/* 132 */ NdrFcShort( 0x18 ), /* x86 Stack size/offset = 24 */
#endif
#endif
#endif
```

Appendix A - Application Source Code

```

                                NdrFcShort( 0x1c ), /* MIPS Stack size/offset = 28 */
#endif
#else
                                NdrFcShort( 0x1c ), /* PPC Stack size/offset = 28 */
#endif
#else
                                NdrFcShort( 0x20 ), /* Alpha Stack size/offset = 32 */
#endif
/* 134 */ /* 0x8,
                                /* FC_LONG */
                                0x0,
                                /* 0 */

                                /* Procedure OrderStatus */

/* 136 */ /* 0x33,
                                /* FC_AUTO_HANDLE */
                                0x6c,
                                /* Old Flags: object, Oi2 */

/* 138 */ /* NdrFcLong( 0x0 ), /* 0 */
/* 142 */ /* NdrFcShort( 0x7 ), /* 7 */
#ifndef _ALPHA_
#ifndef _PPC_
#if !defined(_MIPS_)
/* 144 */ /* NdrFcShort( 0x1c ), /* x86 Stack size/offset = 28 */
#else
                                NdrFcShort( 0x20 ), /* MIPS Stack size/offset = 32 */
#endif
#else
                                NdrFcShort( 0x20 ), /* PPC Stack size/offset = 32 */
#endif
#else
                                NdrFcShort( 0x28 ), /* Alpha Stack size/offset = 40 */
#endif
/* 146 */ /* NdrFcShort( 0x0 ), /* 0 */
/* 148 */ /* NdrFcShort( 0x8 ), /* 8 */
/* 150 */ /* 0x7,
                                /* Oi2 Flags: srv must size, clt must size, has return, */
                                0x3,
                                /* 3 */

                                /* Parameter txn_in */

/* 152 */ /* NdrFcShort( 0x8b ), /* Flags: must size, must free, in, by val, */
#ifndef _ALPHA_
#ifndef _PPC_
#if !defined(_MIPS_)
/* 154 */ /* NdrFcShort( 0x4 ), /* x86 Stack size/offset = 4 */
#else
                                NdrFcShort( 0x8 ), /* MIPS Stack size/offset = 8 */
#endif
#else
                                NdrFcShort( 0x8 ), /* PPC Stack size/offset = 8 */
#endif
#else
                                NdrFcShort( 0x8 ), /* Alpha Stack size/offset = 8 */
#endif
/* 156 */ /* NdrFcShort( 0x3c8 ), /* Type Offset=968 */

                                /* Parameter txn_out */

/* 158 */ /* NdrFcShort( 0x4113 ), /* Flags: must size, must free, out, simple ref,
srv alloc size=16 */
#ifndef _ALPHA_
#ifndef _PPC_
#if !defined(_MIPS_)
/* 160 */ /* NdrFcShort( 0x14 ), /* x86 Stack size/offset = 20 */
#else
                                NdrFcShort( 0x18 ), /* MIPS Stack size/offset = 24 */

```

```

#endif
#else
                                NdrFcShort( 0x18 ), /* PPC Stack size/offset = 24 */
#endif
#else
                                NdrFcShort( 0x18 ), /* Alpha Stack size/offset = 24 */
#endif
/* 162 */ /* NdrFcShort( 0x3da ), /* Type Offset=986 */

                                /* Return value */

/* 164 */ /* NdrFcShort( 0x70 ), /* Flags: out, return, base type, */
#ifndef _ALPHA_
#ifndef _PPC_
#if !defined(_MIPS_)
/* 166 */ /* NdrFcShort( 0x18 ), /* x86 Stack size/offset = 24 */
#else
                                NdrFcShort( 0x1c ), /* MIPS Stack size/offset = 28 */
#endif
#else
                                NdrFcShort( 0x1c ), /* PPC Stack size/offset = 28 */
#endif
#else
                                NdrFcShort( 0x20 ), /* Alpha Stack size/offset = 32 */
#endif
/* 168 */ /* 0x8,
                                /* FC_LONG */
                                0x0,
                                /* 0 */

                                /* Procedure CallSetComplete */

/* 170 */ /* 0x33,
                                /* FC_AUTO_HANDLE */
                                0x6c,
                                /* Old Flags: object, Oi2 */

/* 172 */ /* NdrFcLong( 0x0 ), /* 0 */
/* 176 */ /* NdrFcShort( 0x8 ), /* 8 */
#ifndef _ALPHA_
/* 178 */ /* NdrFcShort( 0x8 ), /* x86, MIPS, PPC Stack size/offset = 8 */
#else
                                NdrFcShort( 0x10 ), /* Alpha Stack size/offset = 16 */
#endif
/* 180 */ /* NdrFcShort( 0x0 ), /* 0 */
/* 182 */ /* NdrFcShort( 0x8 ), /* 8 */
/* 184 */ /* 0x4,
                                /* Oi2 Flags: has return, */
                                0x1,
                                /* 1 */

                                /* Return value */

/* 186 */ /* NdrFcShort( 0x70 ), /* Flags: out, return, base type, */
#ifndef _ALPHA_
/* 188 */ /* NdrFcShort( 0x4 ), /* x86, MIPS, PPC Stack size/offset = 4 */
#else
                                NdrFcShort( 0x8 ), /* Alpha Stack size/offset = 8 */
#endif
/* 190 */ /* 0x8,
                                /* FC_LONG */
                                0x0,
                                /* 0 */

                                0x0

                                }
};

static const MIDL_TYPE_FORMAT_STRING __MIDL_TypeFormatString =
{
    0,
    {

```

Appendix A - Application Source Code

```

NdrFcShort( 0x0 ), /* 0 */
/* 2 */
0x12, 0x0, /* FC_UP */
/* 4 */ NdrFcShort( 0x3b0 ), /* Offset= 944 (948) */
/* 6 */
0x2b, /* FC_NON_ENCAPSULATED_UNION */
0x9, /* FC_ULONG */
/* 8 */ 0x7, /* Corr desc: FC_USHORT */
0x0, /* */
/* 10 */ NdrFcShort( 0xffff8 ), /* -8 */
/* 12 */ NdrFcShort( 0x2 ), /* Offset= 2 (14) */
/* 14 */ NdrFcShort( 0x10 ), /* 16 */
/* 16 */ NdrFcShort( 0x2b ), /* 43 */
/* 18 */ NdrFcLong( 0x3 ), /* 3 */
/* 22 */ NdrFcShort( 0x8008 ), /* Simple arm type: FC_LONG */
/* 24 */ NdrFcLong( 0x11 ), /* 17 */
/* 28 */ NdrFcShort( 0x8001 ), /* Simple arm type: FC_BYTE */
/* 30 */ NdrFcLong( 0x2 ), /* 2 */
/* 34 */ NdrFcShort( 0x8006 ), /* Simple arm type: FC_SHORT */
/* 36 */ NdrFcLong( 0x4 ), /* 4 */
/* 40 */ NdrFcShort( 0x800a ), /* Simple arm type: FC_FLOAT */
/* 42 */ NdrFcLong( 0x5 ), /* 5 */
/* 46 */ NdrFcShort( 0x800c ), /* Simple arm type: FC_DOUBLE */
/* 48 */ NdrFcLong( 0xb ), /* 11 */
/* 52 */ NdrFcShort( 0x8006 ), /* Simple arm type: FC_SHORT */
/* 54 */ NdrFcLong( 0xa ), /* 10 */
/* 58 */ NdrFcShort( 0x8008 ), /* Simple arm type: FC_LONG */
/* 60 */ NdrFcLong( 0x6 ), /* 6 */
/* 64 */ NdrFcShort( 0xd6 ), /* Offset= 214 (278) */
/* 66 */ NdrFcLong( 0x7 ), /* 7 */
/* 70 */ NdrFcShort( 0x800c ), /* Simple arm type: FC_DOUBLE */
/* 72 */ NdrFcLong( 0x8 ), /* 8 */
/* 76 */ NdrFcShort( 0xd0 ), /* Offset= 208 (284) */
/* 78 */ NdrFcLong( 0xd ), /* 13 */
/* 82 */ NdrFcShort( 0xe2 ), /* Offset= 226 (308) */
/* 84 */ NdrFcLong( 0x9 ), /* 9 */
/* 88 */ NdrFcShort( 0xee ), /* Offset= 238 (326) */
/* 90 */ NdrFcLong( 0x2000 ), /* 8192 */
/* 94 */ NdrFcShort( 0xfa ), /* Offset= 250 (344) */
/* 96 */ NdrFcLong( 0x24 ), /* 36 */
/* 100 */ NdrFcShort( 0x308 ), /* Offset= 776 (876) */
/* 102 */ NdrFcLong( 0x4024 ), /* 16420 */
/* 106 */ NdrFcShort( 0x302 ), /* Offset= 770 (876) */
/* 108 */ NdrFcLong( 0x4011 ), /* 16401 */
/* 112 */ NdrFcShort( 0x300 ), /* Offset= 768 (880) */
/* 114 */ NdrFcLong( 0x4002 ), /* 16386 */
/* 118 */ NdrFcShort( 0x2fe ), /* Offset= 766 (884) */
/* 120 */ NdrFcLong( 0x4003 ), /* 16387 */
/* 124 */ NdrFcShort( 0x2fc ), /* Offset= 764 (888) */
/* 126 */ NdrFcLong( 0x4004 ), /* 16388 */
/* 130 */ NdrFcShort( 0x2fa ), /* Offset= 762 (892) */
/* 132 */ NdrFcLong( 0x4005 ), /* 16389 */
/* 136 */ NdrFcShort( 0x2f8 ), /* Offset= 760 (896) */
/* 138 */ NdrFcLong( 0x400b ), /* 16395 */
/* 142 */ NdrFcShort( 0x2e6 ), /* Offset= 742 (884) */
/* 144 */ NdrFcLong( 0x400a ), /* 16394 */
/* 148 */ NdrFcShort( 0x2e4 ), /* Offset= 740 (888) */
/* 150 */ NdrFcLong( 0x4006 ), /* 16390 */
/* 154 */ NdrFcShort( 0x2ea ), /* Offset= 746 (900) */
/* 156 */ NdrFcLong( 0x4007 ), /* 16391 */
/* 160 */ NdrFcShort( 0x2e0 ), /* Offset= 736 (896) */
/* 162 */ NdrFcLong( 0x4008 ), /* 16392 */
/* 166 */ NdrFcShort( 0x2e2 ), /* Offset= 738 (904) */
/* 168 */ NdrFcLong( 0x400d ), /* 16397 */
/* 172 */ NdrFcShort( 0x2e0 ), /* Offset= 736 (908) */
/* 174 */ NdrFcLong( 0x4009 ), /* 16393 */
/* 178 */ NdrFcShort( 0x2de ), /* Offset= 734 (912) */
/* 180 */ NdrFcLong( 0x6000 ), /* 24576 */
/* 184 */ NdrFcShort( 0x2dc ), /* Offset= 732 (916) */
/* 186 */ NdrFcLong( 0x400c ), /* 16396 */
/* 190 */ NdrFcShort( 0x2da ), /* Offset= 730 (920) */
/* 192 */ NdrFcLong( 0x10 ), /* 16 */
/* 196 */ NdrFcShort( 0x8002 ), /* Simple arm type: FC_CHAR */
/* 198 */ NdrFcLong( 0x12 ), /* 18 */
/* 202 */ NdrFcShort( 0x8006 ), /* Simple arm type: FC_SHORT */
/* 204 */ NdrFcLong( 0x13 ), /* 19 */
/* 208 */ NdrFcShort( 0x8008 ), /* Simple arm type: FC_LONG */
/* 210 */ NdrFcLong( 0x16 ), /* 22 */
/* 214 */ NdrFcShort( 0x8008 ), /* Simple arm type: FC_LONG */
/* 216 */ NdrFcLong( 0x17 ), /* 23 */
/* 220 */ NdrFcShort( 0x8008 ), /* Simple arm type: FC_LONG */
/* 222 */ NdrFcLong( 0xe ), /* 14 */
/* 226 */ NdrFcShort( 0x2be ), /* Offset= 702 (928) */
/* 228 */ NdrFcLong( 0x400e ), /* 16398 */
/* 232 */ NdrFcShort( 0x2c4 ), /* Offset= 708 (940) */
/* 234 */ NdrFcLong( 0x4010 ), /* 16400 */
/* 238 */ NdrFcShort( 0x2c2 ), /* Offset= 706 (944) */
/* 240 */ NdrFcLong( 0x4012 ), /* 16402 */
/* 244 */ NdrFcShort( 0x280 ), /* Offset= 640 (884) */
/* 246 */ NdrFcLong( 0x4013 ), /* 16403 */
/* 250 */ NdrFcShort( 0x27e ), /* Offset= 638 (888) */
/* 252 */ NdrFcLong( 0x4016 ), /* 16406 */
/* 256 */ NdrFcShort( 0x278 ), /* Offset= 632 (888) */
/* 258 */ NdrFcLong( 0x4017 ), /* 16407 */
/* 262 */ NdrFcShort( 0x272 ), /* Offset= 626 (888) */
/* 264 */ NdrFcLong( 0x0 ), /* 0 */
/* 268 */ NdrFcShort( 0x0 ), /* Offset= 0 (268) */
/* 270 */ NdrFcLong( 0x1 ), /* 1 */
/* 274 */ NdrFcShort( 0x0 ), /* Offset= 0 (274) */
/* 276 */ NdrFcShort( 0xffffffff ), /* Offset= -1 (275) */
/* 278 */
0x15, /* FC_STRUCT */
0x7, /* 7 */
/* 280 */ NdrFcShort( 0x8 ), /* 8 */
/* 282 */ 0xb, /* FC_HYPER */
0x5b, /* FC_END */
/* 284 */
0x12, 0x0, /* FC_UP */
/* 286 */ NdrFcShort( 0xc ), /* Offset= 12 (298) */
/* 288 */
0x1b, /* FC_CARRAY */
0x1, /* 1 */
/* 290 */ NdrFcShort( 0x2 ), /* 2 */
/* 292 */ 0x9, /* Corr desc: FC_ULONG */
0x0, /* */
/* 294 */ NdrFcShort( 0xffffc ), /* -4 */
/* 296 */ 0x6, /* FC_SHORT */
0x5b, /* FC_END */
/* 298 */
0x17, /* FC_CSTRUCT */
0x3, /* 3 */
/* 300 */ NdrFcShort( 0x8 ), /* 8 */
/* 302 */ NdrFcShort( 0xffffffff2 ), /* Offset= -14 (288) */
/* 304 */ 0x8, /* FC_LONG */
0x8, /* FC_LONG */
/* 306 */ 0x5c, /* FC_PAD */
```

Appendix A - Application Source Code

```
/* 308 */          0x5b,          /* FC_END */
/* 310 */ NdrFcLong( 0x0 ), /* 0 */
/* 314 */ NdrFcShort( 0x0 ), /* 0 */
/* 316 */ NdrFcShort( 0x0 ), /* 0 */
/* 318 */ 0xc0,          /* 192 */
/* 320 */ 0x0,          /* 0 */
/* 322 */ 0x0,          /* 0 */
/* 324 */ 0x0,          /* 0 */
/* 326 */          0x46,          /* 70 */
/* 328 */ NdrFcLong( 0x20400 ), /* 132096 */
/* 332 */ NdrFcShort( 0x0 ), /* 0 */
/* 334 */ NdrFcShort( 0x0 ), /* 0 */
/* 336 */ 0xc0,          /* 192 */
/* 338 */ 0x0,          /* 0 */
/* 340 */ 0x0,          /* 0 */
/* 342 */ 0x0,          /* 0 */
/* 344 */          0x46,          /* 70 */
/* 346 */ NdrFcShort( 0x2 ), /* Offset= 2 (348) */
/* 348 */          0x12, 0x10, /* FC_UP [pointer_deref] */
/* 350 */ NdrFcShort( 0x1fc ), /* Offset= 508 (858) */
/* 352 */          0x12, 0x0, /* FC_UP */
/* 354 */          0x2a,          /* FC_ENCAPSULATED_UNION */
/* 356 */ NdrFcShort( 0x18 ), /* 24 */
/* 358 */ NdrFcShort( 0xa ), /* 10 */
/* 360 */ NdrFcLong( 0x8 ), /* 8 */
/* 362 */ NdrFcShort( 0x58 ), /* Offset= 88 (450) */
/* 364 */ NdrFcLong( 0xd ), /* 13 */
/* 366 */ NdrFcShort( 0x78 ), /* Offset= 120 (488) */
/* 368 */ NdrFcLong( 0x9 ), /* 9 */
/* 370 */ NdrFcShort( 0x94 ), /* Offset= 148 (522) */
/* 372 */ NdrFcLong( 0xc ), /* 12 */
/* 374 */ NdrFcShort( 0xbc ), /* Offset= 188 (568) */
/* 376 */ NdrFcLong( 0x24 ), /* 36 */
/* 378 */ NdrFcShort( 0x114 ), /* Offset= 276 (662) */
/* 380 */ NdrFcLong( 0x800d ), /* 32781 */
/* 382 */ NdrFcShort( 0x130 ), /* Offset= 304 (696) */
/* 384 */ NdrFcLong( 0x10 ), /* 16 */
/* 386 */ NdrFcShort( 0x148 ), /* Offset= 328 (726) */
/* 388 */ NdrFcLong( 0x2 ), /* 2 */
/* 390 */ NdrFcShort( 0x160 ), /* Offset= 352 (756) */
/* 392 */ NdrFcLong( 0x3 ), /* 3 */
/* 394 */ NdrFcShort( 0x178 ), /* Offset= 376 (786) */
/* 396 */ NdrFcLong( 0x14 ), /* 20 */
/* 398 */ NdrFcShort( 0x190 ), /* Offset= 400 (816) */
/* 400 */ NdrFcShort( 0xfffffff ), /* Offset= -1 (417) */
/* 402 */          0x1b,          /* FC_CARRAY */

/* 422 */ NdrFcShort( 0x4 ), /* 4 */
/* 424 */ 0x19,          /* Corr desc: field pointer, FC_ULONG */
/* 426 */ NdrFcShort( 0x0 ), /* 0 */
/* 428 */          0x4b,          /* FC_PP */
/* 430 */          0x5c,          /* FC_PAD */
/* 432 */          0x48,          /* FC_VARIABLE_REPEAT */
/* 434 */ NdrFcShort( 0x4 ), /* 4 */
/* 436 */ NdrFcShort( 0x0 ), /* 0 */
/* 438 */ NdrFcShort( 0x1 ), /* 1 */
/* 440 */ NdrFcShort( 0x0 ), /* 0 */
/* 442 */ 0x12, 0x0, /* FC_UP */
/* 444 */ NdrFcShort( 0xfffff6e ), /* Offset= -146 (298) */
/* 446 */          0x5b,          /* FC_END */
/* 448 */ 0x5c,          /* FC_PAD */
/* 450 */          0x5b,          /* FC_END */
/* 452 */ NdrFcShort( 0x8 ), /* 8 */
/* 454 */          0x16,          /* FC_PSTRUCT */
/* 456 */          0x3,          /* 3 */
/* 458 */          0x4b,          /* FC_PP */
/* 460 */ NdrFcShort( 0x4 ), /* 4 */
/* 462 */ 0x11, 0x0, /* FC_LP */
/* 464 */ NdrFcShort( 0xfffffd4 ), /* Offset= -44 (420) */
/* 466 */          0x5b,          /* FC_END */
/* 468 */ 0x8,          /* FC_LONG */
/* 470 */          0x5b,          /* FC_END */
/* 472 */ NdrFcShort( 0x0 ), /* 0 */
/* 474 */ 0x19,          /* Corr desc: field pointer, FC_ULONG */
/* 476 */ NdrFcShort( 0x0 ), /* 0 */
/* 478 */ NdrFcLong( 0xfffffff ), /* -1 */
/* 480 */ 0x4c,          /* FC_EMBEDDED_COMPLEX */
/* 482 */          0x0,          /* 0 */
/* 484 */ NdrFcShort( 0xfffff50 ), /* Offset= -176 (308) */
/* 486 */ 0x5c,          /* FC_PAD */
/* 488 */          0x5b,          /* FC_END */
/* 490 */ NdrFcShort( 0x8 ), /* 8 */
/* 492 */ NdrFcShort( 0x0 ), /* 0 */
/* 494 */ NdrFcShort( 0x6 ), /* Offset= 6 (500) */
```

Appendix A - Application Source Code

```
/* 496 */ 0x8, /* FC_LONG */
/* 498 */ 0x5c, /* FC_PAD */
/* 500 */ 0x5b, /* FC_END */
/* 502 */ NdrFcShort( 0xffffffe0 ), /* Offset= -32 (470) */
/* 504 */ 0x11, 0x0, /* FC_RP */
/* 506 */ NdrFcShort( 0x0 ), /* 0 */
/* 508 */ 0x19, /* Corr desc: field pointer, FC_ULONG */
/* 510 */ NdrFcShort( 0x0 ), /* 0 */
/* 512 */ NdrFcLong( 0xffffffff ), /* -1 */
/* 516 */ 0x4c, /* FC_EMBEDDED_COMPLEX */
/* 518 */ NdrFcShort( 0xffffff40 ), /* Offset= -192 (326) */
/* 520 */ 0x5c, /* FC_PAD */
/* 522 */ 0x5b, /* FC_END */
/* 524 */ NdrFcShort( 0x1a ), /* FC_BOGUS_STRUCT */
/* 526 */ NdrFcShort( 0x03 ), /* 3 */
/* 528 */ NdrFcShort( 0x08 ), /* 8 */
/* 530 */ 0x19, /* Corr desc: field pointer, FC_ULONG */
/* 532 */ 0x5c, /* FC_PAD */
/* 534 */ 0x5b, /* FC_END */
/* 536 */ NdrFcShort( 0x11, 0x0 ), /* FC_RP */
/* 538 */ 0x1b, /* FC_CARRAY */
/* 540 */ NdrFcShort( 0x03 ), /* 3 */
/* 542 */ 0x19, /* Corr desc: field pointer, FC_ULONG */
/* 544 */ NdrFcShort( 0x04 ), /* 4 */
/* 546 */ 0x0, /* 0 */
/* 548 */ 0x4b, /* FC_PP */
/* 550 */ NdrFcShort( 0x5c ), /* FC_PAD */
/* 552 */ 0x48, /* FC_VARIABLE_REPEAT */
/* 554 */ NdrFcShort( 0x49 ), /* FC_FIXED_OFFSET */
/* 556 */ NdrFcShort( 0x04 ), /* 4 */
/* 558 */ NdrFcShort( 0x0 ), /* 0 */
/* 560 */ 0x12, 0x0, /* FC_UP */
/* 562 */ NdrFcShort( 0x182 ), /* Offset= 386 (948) */
/* 564 */ 0x5b, /* FC_END */
/* 566 */ 0x8, /* FC_LONG */
/* 568 */ 0x5c, /* FC_PAD */
/* 570 */ NdrFcShort( 0x5b ), /* FC_END */
/* 572 */ NdrFcShort( 0x0 ), /* 0 */
/* 574 */ NdrFcShort( 0x6 ), /* Offset= 6 (580) */
/* 576 */ 0x8, /* FC_LONG */
/* 578 */ 0x5c, /* FC_PAD */
/* 580 */ 0x5b, /* FC_END */
/* 582 */ NdrFcShort( 0x11, 0x0 ), /* FC_RP */
/* 584 */ 0xffffffd4, /* Offset= -44 (538) */
/* 586 */ 0x2f, /* FC_IP */
/* 588 */ 0x5a, /* FC_CONSTANT_IID */
/* 590 */ NdrFcLong( 0x2f ), /* 47 */
/* 592 */ NdrFcShort( 0x0 ), /* 0 */
/* 594 */ 0xc0, /* 192 */
/* 596 */ 0x0, /* 0 */
/* 598 */ 0x0, /* 0 */
/* 600 */ 0x0, /* 0 */
/* 602 */ 0x46, /* 70 */
/* 604 */ NdrFcShort( 0x1b ), /* FC_CARRAY */
/* 606 */ 0x0, /* 0 */
/* 608 */ NdrFcShort( 0x1 ), /* 1 */
/* 610 */ 0x19, /* Corr desc: field pointer, FC_ULONG */
/* 612 */ 0x0, /* 0 */
/* 614 */ NdrFcShort( 0x4 ), /* 4 */
/* 616 */ 0x1, /* FC_BYTE */
/* 618 */ 0x5b, /* FC_END */
/* 620 */ 0x1a, /* FC_BOGUS_STRUCT */
/* 622 */ NdrFcShort( 0x03 ), /* 3 */
/* 624 */ NdrFcShort( 0x10 ), /* 16 */
/* 626 */ NdrFcShort( 0x0 ), /* 0 */
/* 628 */ 0x8, /* Offset= 10 (628) */
/* 630 */ 0x4c, /* FC_LONG */
/* 632 */ 0x8, /* FC_LONG */
/* 634 */ NdrFcShort( 0x4b ), /* FC_EMBEDDED_COMPLEX */
/* 636 */ 0x5c, /* 0 */
/* 638 */ NdrFcShort( 0xffffffd8 ), /* Offset= -40 (584) */
/* 640 */ 0x36, /* FC_POINTER */
/* 642 */ 0x5b, /* FC_END */
/* 644 */ NdrFcShort( 0x12, 0x0 ), /* FC_UP */
/* 646 */ NdrFcShort( 0xffffffe4 ), /* Offset= -28 (602) */
/* 648 */ 0x1b, /* FC_CARRAY */
/* 650 */ NdrFcShort( 0x03 ), /* 3 */
/* 652 */ NdrFcShort( 0x4 ), /* 4 */
/* 654 */ 0x19, /* Corr desc: field pointer, FC_ULONG */
/* 656 */ 0x0, /* 0 */
/* 658 */ NdrFcShort( 0x0 ), /* 0 */
/* 660 */ 0x4b, /* FC_PP */
/* 662 */ 0x5c, /* FC_PAD */
/* 664 */ 0x48, /* FC_VARIABLE_REPEAT */
/* 666 */ 0x49, /* FC_FIXED_OFFSET */
/* 668 */ NdrFcShort( 0x04 ), /* 4 */
/* 670 */ NdrFcShort( 0x0 ), /* 0 */
```

Appendix A - Application Source Code

```
/* 648 */ NdrFcShort( 0x1 ), /* 1 */
/* 650 */ NdrFcShort( 0x0 ), /* 0 */
/* 652 */ NdrFcShort( 0x0 ), /* 0 */
/* 654 */ 0x12, 0x0, /* FC_UP */
/* 656 */ NdrFcShort( 0xffffffffd4 ), /* Offset= -44 (612) */
/* 658 */
    0x5b, /* FC_END */
    0x8, /* FC_LONG */
/* 660 */ 0x5c, /* FC_PAD */
    0x5b, /* FC_END */
/* 662 */
    0x1a, /* FC_BOGUS_STRUCT */
    0x3, /* 3 */
/* 664 */ NdrFcShort( 0x8 ), /* 8 */
/* 666 */ NdrFcShort( 0x0 ), /* 0 */
/* 668 */ NdrFcShort( 0x6 ), /* Offset= 6 (674) */
/* 670 */ 0x8, /* FC_LONG */
/* 672 */ 0x5c, /* FC_PAD */
    0x5b, /* FC_END */
/* 674 */
    0x11, 0x0, /* FC_RP */
/* 676 */ NdrFcShort( 0xffffffffd4 ), /* Offset= -44 (632) */
/* 678 */
    0x1d, /* FC_SMFARRAY */
    0x0, /* 0 */
/* 680 */ NdrFcShort( 0x8 ), /* 8 */
/* 682 */ 0x2, /* FC_CHAR */
    0x5b, /* FC_END */
/* 684 */
    0x15, /* FC_STRUCT */
    0x3, /* 3 */
/* 686 */ NdrFcShort( 0x10 ), /* 16 */
/* 688 */ 0x8, /* FC_LONG */
    0x6, /* FC_SHORT */
/* 690 */ 0x6, /* FC_SHORT */
    0x4c, /* FC_EMBEDDED_COMPLEX */
/* 692 */ 0x0, /* 0 */
    NdrFcShort( 0xfffffffff1 ), /* Offset= -15 (678) */
    0x5b, /* FC_END */
/* 696 */
    0x1a, /* FC_BOGUS_STRUCT */
    0x3, /* 3 */
/* 698 */ NdrFcShort( 0x18 ), /* 24 */
/* 700 */ NdrFcShort( 0x0 ), /* 0 */
/* 702 */ NdrFcShort( 0xa ), /* Offset= 10 (712) */
/* 704 */ 0x8, /* FC_LONG */
    0x36, /* FC_POINTER */
/* 706 */ 0x4c, /* FC_EMBEDDED_COMPLEX */
    0x0, /* 0 */
/* 708 */ NdrFcShort( 0xffffffffe8 ), /* Offset= -24 (684) */
/* 710 */ 0x5c, /* FC_PAD */
    0x5b, /* FC_END */
/* 712 */
    0x11, 0x0, /* FC_RP */
/* 714 */ NdrFcShort( 0xffffffff0c ), /* Offset= -244 (470) */
/* 716 */
    0x1b, /* FC_CARRAY */
    0x0, /* 0 */
/* 718 */ NdrFcShort( 0x1 ), /* 1 */
/* 720 */ 0x19, /* Corr desc: field pointer, FC_ULONG */
    0x0, /* */
```

```
/* 722 */ NdrFcShort( 0x0 ), /* 0 */
/* 724 */ 0x1, /* FC_BYTE */
    0x5b, /* FC_END */
/* 726 */
    0x16, /* FC_PSTRUCT */
    0x3, /* 3 */
/* 728 */ NdrFcShort( 0x8 ), /* 8 */
/* 730 */
    0x4b, /* FC_PP */
    0x5c, /* FC_PAD */
/* 732 */
    0x46, /* FC_NO_REPEAT */
    0x5c, /* FC_PAD */
/* 734 */ NdrFcShort( 0x4 ), /* 4 */
/* 736 */ NdrFcShort( 0x4 ), /* 4 */
/* 738 */ 0x12, 0x0, /* FC_UP */
/* 740 */ NdrFcShort( 0xffffffffe8 ), /* Offset= -24 (716) */
/* 742 */
    0x5b, /* FC_END */
    0x8, /* FC_LONG */
/* 744 */ 0x8, /* FC_LONG */
    0x5b, /* FC_END */
/* 746 */
    0x1b, /* FC_CARRAY */
    0x1, /* 1 */
/* 748 */ NdrFcShort( 0x2 ), /* 2 */
/* 750 */ 0x19, /* Corr desc: field pointer, FC_ULONG */
    0x0, /* */
/* 752 */ NdrFcShort( 0x0 ), /* 0 */
/* 754 */ 0x6, /* FC_SHORT */
    0x5b, /* FC_END */
/* 756 */
    0x16, /* FC_PSTRUCT */
    0x3, /* 3 */
/* 758 */ NdrFcShort( 0x8 ), /* 8 */
/* 760 */
    0x4b, /* FC_PP */
    0x5c, /* FC_PAD */
/* 762 */
    0x46, /* FC_NO_REPEAT */
    0x5c, /* FC_PAD */
/* 764 */ NdrFcShort( 0x4 ), /* 4 */
/* 766 */ NdrFcShort( 0x4 ), /* 4 */
/* 768 */ 0x12, 0x0, /* FC_UP */
/* 770 */ NdrFcShort( 0xffffffffe8 ), /* Offset= -24 (746) */
/* 772 */
    0x5b, /* FC_END */
    0x8, /* FC_LONG */
/* 774 */ 0x8, /* FC_LONG */
    0x5b, /* FC_END */
/* 776 */
    0x1b, /* FC_CARRAY */
    0x3, /* 3 */
/* 778 */ NdrFcShort( 0x4 ), /* 4 */
/* 780 */ 0x19, /* Corr desc: field pointer, FC_ULONG */
    0x0, /* */
/* 782 */ NdrFcShort( 0x0 ), /* 0 */
/* 784 */ 0x8, /* FC_LONG */
    0x5b, /* FC_END */
/* 786 */
    0x16, /* FC_PSTRUCT */
```

Appendix A - Application Source Code

```
/* 788 */ NdrFcShort( 0x8 ), /* 8 */
/* 790 */
                                0x4b, /* FC_PP */
                                0x5c, /* FC_PAD */
/* 792 */
                                0x46, /* FC_NO_REPEAT */
                                0x5c, /* FC_PAD */
/* 794 */ NdrFcShort( 0x4 ), /* 4 */
/* 796 */ NdrFcShort( 0x4 ), /* 4 */
/* 798 */ 0x12, 0x0, /* FC_UP */
/* 800 */ NdrFcShort( 0xfffffe8 ), /* Offset= -24 (776) */
/* 802 */
                                0x5b, /* FC_END */
/* 804 */ 0x8,
                                0x8, /* FC_LONG */
                                0x5b, /* FC_END */
/* 806 */
                                0x1b, /* FC_CARRAY */
                                0x7, /* 7 */
/* 808 */ NdrFcShort( 0x8 ), /* 8 */
/* 810 */ 0x19, /* Corr desc: field pointer, FC_ULONG */
                                0x0, /* */
/* 812 */ NdrFcShort( 0x0 ), /* 0 */
/* 814 */ 0xb, /* FC_HYPER */
                                0x5b, /* FC_END */
/* 816 */
                                0x16, /* FC_PSTRUCT */
                                0x3, /* 3 */
/* 818 */ NdrFcShort( 0x8 ), /* 8 */
/* 820 */
                                0x4b, /* FC_PP */
                                0x5c, /* FC_PAD */
/* 822 */
                                0x46, /* FC_NO_REPEAT */
                                0x5c, /* FC_PAD */
/* 824 */ NdrFcShort( 0x4 ), /* 4 */
/* 826 */ NdrFcShort( 0x4 ), /* 4 */
/* 828 */ 0x12, 0x0, /* FC_UP */
/* 830 */ NdrFcShort( 0xfffffe8 ), /* Offset= -24 (806) */
/* 832 */
                                0x5b, /* FC_END */
/* 834 */ 0x8,
                                0x8, /* FC_LONG */
                                0x5b, /* FC_END */
/* 836 */
                                0x15, /* FC_STRUCT */
                                0x3, /* 3 */
/* 838 */ NdrFcShort( 0x8 ), /* 8 */
/* 840 */ 0x8, /* FC_LONG */
                                0x8, /* FC_LONG */
                                0x5c, /* FC_PAD */
                                0x5b, /* FC_END */
/* 844 */
                                0x1b, /* FC_CARRAY */
                                0x3, /* 3 */
/* 846 */ NdrFcShort( 0x8 ), /* 8 */
/* 848 */ 0x7, /* Corr desc: FC_USHORT */
                                0x0, /* */
/* 850 */ NdrFcShort( 0xffd8 ), /* -40 */
/* 852 */ 0x4c, /* FC_EMBEDDED_COMPLEX */

                                0x0, /* 0 */
/* 854 */ NdrFcShort( 0xfffffee ), /* Offset= -18 (836) */
/* 856 */ 0x5c, /* FC_PAD */
                                0x5b, /* FC_END */
/* 858 */
                                0x1a, /* FC_BOGUS_STRUCT */
                                0x3, /* 3 */
/* 860 */ NdrFcShort( 0x28 ), /* 40 */
/* 862 */ NdrFcShort( 0xfffffee ), /* Offset= -18 (844) */
/* 864 */ NdrFcShort( 0x0 ), /* Offset= 0 (864) */
/* 866 */ 0x6, /* FC_SHORT */
                                0x6, /* FC_SHORT */
/* 868 */ 0x38, /* FC_ALIGNM4 */
                                0x8, /* FC_LONG */
/* 870 */ 0x8, /* FC_LONG */
                                0x4c, /* FC_EMBEDDED_COMPLEX */
/* 872 */ 0x0, /* 0 */
                                NdrFcShort( 0xffffdf7 ), /* Offset= -521 (352) */
                                0x5b, /* FC_END */
/* 876 */
                                0x12, 0x0, /* FC_UP */
/* 878 */ NdrFcShort( 0xffffef6 ), /* Offset= -266 (612) */
/* 880 */
                                0x12, 0x8, /* FC_UP [simple_pointer] */
/* 882 */ 0x1, /* FC_BYTE */
                                0x5c, /* FC_PAD */
/* 884 */
                                0x12, 0x8, /* FC_UP [simple_pointer] */
/* 886 */ 0x6, /* FC_SHORT */
                                0x5c, /* FC_PAD */
/* 888 */
                                0x12, 0x8, /* FC_UP [simple_pointer] */
/* 890 */ 0x8, /* FC_LONG */
                                0x5c, /* FC_PAD */
/* 892 */
                                0x12, 0x8, /* FC_UP [simple_pointer] */
/* 894 */ 0xa, /* FC_FLOAT */
                                0x5c, /* FC_PAD */
/* 896 */
                                0x12, 0x8, /* FC_UP [simple_pointer] */
/* 898 */ 0xc, /* FC_DOUBLE */
                                0x5c, /* FC_PAD */
/* 900 */
                                0x12, 0x0, /* FC_UP */
/* 902 */ NdrFcShort( 0xffffd90 ), /* Offset= -624 (278) */
/* 904 */
                                0x12, 0x10, /* FC_UP [pointer_deref] */
/* 906 */ NdrFcShort( 0xffffd92 ), /* Offset= -622 (284) */
/* 908 */
                                0x12, 0x10, /* FC_UP [pointer_deref] */
/* 910 */ NdrFcShort( 0xffffda6 ), /* Offset= -602 (308) */
/* 912 */
                                0x12, 0x10, /* FC_UP [pointer_deref] */
/* 914 */ NdrFcShort( 0xffffdb4 ), /* Offset= -588 (326) */
/* 916 */
                                0x12, 0x10, /* FC_UP [pointer_deref] */
/* 918 */ NdrFcShort( 0xffffdc2 ), /* Offset= -574 (344) */
/* 920 */
                                0x12, 0x10, /* FC_UP [pointer_deref] */
/* 922 */ NdrFcShort( 0x2 ), /* Offset= 2 (924) */
/* 924 */
                                0x12, 0x0, /* FC_UP */
/* 926 */ NdrFcShort( 0x16 ), /* Offset= 22 (948) */
```

Appendix A - Application Source Code

```
/* 928 */
                                0x15,          /* FC_STRUCT */
                                0x7,          /* 7 */
/* 930 */ NdrFcShort( 0x10 ), /* 16 */
/* 932 */ 0x6,              /* FC_SHORT */
                                0x1,          /* FC_BYTE */
/* 934 */ 0x1,              /* FC_BYTE */
                                0x38,         /* FC_ALIGNM4 */
/* 936 */ 0x8,              /* FC_LONG */
                                0x39,         /* FC_ALIGNM8 */
/* 938 */ 0xb,              /* FC_HYPER */
                                0x5b,         /* FC_END */
/* 940 */
                                0x12, 0x0,     /* FC_UP */
/* 942 */ NdrFcShort( 0xffffffff2 ), /* Offset= -14 (928) */
/* 944 */
                                0x12, 0x8,     /* FC_UP [simple_pointer] */
/* 946 */ 0x2,              /* FC_CHAR */
                                0x5c,         /* FC_PAD */
/* 948 */
                                0x1a,          /* FC_BOGUS_STRUCT */
                                0x7,          /* 7 */
/* 950 */ NdrFcShort( 0x20 ), /* 32 */
/* 952 */ NdrFcShort( 0x0 ), /* 0 */
/* 954 */ NdrFcShort( 0x0 ), /* Offset= 0 (954) */
/* 956 */ 0x8,              /* FC_LONG */
                                0x8,          /* FC_LONG */
/* 958 */ 0x6,              /* FC_SHORT */
                                0x6,          /* FC_SHORT */
/* 960 */ 0x6,              /* FC_SHORT */
                                0x6,          /* FC_SHORT */
/* 962 */ 0x4c,             /* FC_EMBEDDED_COMPLEX */
                                0x0,          /* 0 */
/* 964 */ NdrFcShort( 0xffffffff42 ), /* Offset= -958 (6) */
/* 966 */ 0x5c,             /* FC_PAD */
                                0x5b,         /* FC_END */
/* 968 */ 0xb4,             /* FC_USER_MARSHAL */
                                0x83,         /* 131 */
/* 970 */ NdrFcShort( 0x0 ), /* 0 */
/* 972 */ NdrFcShort( 0x10 ), /* 16 */
/* 974 */ NdrFcShort( 0x0 ), /* 0 */
/* 976 */ NdrFcShort( 0xffffffff32 ), /* Offset= -974 (2) */
/* 978 */
                                0x11, 0x4,     /* FC_RP [allocated_on_stack] */
/* 980 */ NdrFcShort( 0x6 ), /* Offset= 6 (986) */
/* 982 */
                                0x13, 0x0,     /* FC_OP */
/* 984 */ NdrFcShort( 0xffffffffdc ), /* Offset= -36 (948) */
/* 986 */ 0xb4,             /* FC_USER_MARSHAL */
                                0x83,         /* 131 */
/* 988 */ NdrFcShort( 0x0 ), /* 0 */
/* 990 */ NdrFcShort( 0x10 ), /* 16 */
/* 992 */ NdrFcShort( 0x0 ), /* 0 */
/* 994 */ NdrFcShort( 0xfffffffff4 ), /* Offset= -12 (982) */
                                0x0
    }
};

const CInterfaceProxyVtbl * _tpcc_com_ps_ProxyVtblList[] =
{
    ( CInterfaceProxyVtbl *) &ITPCCProxyVtbl,
    0
};
```

```
};

const CInterfaceStubVtbl * _tpcc_com_ps_StubVtblList[] =
{
    ( CInterfaceStubVtbl *) &ITPCCStubVtbl,
    0
};

PCInterfaceName const _tpcc_com_ps_InterfaceNamesList[] =
{
    "ITPCC",
    0
};

#define _tpcc_com_ps_CHECK_IID(n) IID_GENERIC_CHECK_IID( _tpcc_com_ps, pIID, n)

int __stdcall _tpcc_com_ps_IID_Lookup( const IID * pIID, int * pIndex )
{
    if(!_tpcc_com_ps_CHECK_IID(0))
    {
        *pIndex = 0;
        return 1;
    }

    return 0;
}

const ExtendedProxyFileInfo tpcc_com_ps_ProxyFileInfo =
{
    (PCInterfaceProxyVtblList *) & _tpcc_com_ps_ProxyVtblList,
    (PCInterfaceStubVtblList *) & _tpcc_com_ps_StubVtblList,
    (const PCInterfaceName *) & _tpcc_com_ps_InterfaceNamesList,
    0, // no delegation
    & _tpcc_com_ps_IID_Lookup,
    1,
    2,
    0, /* table of [async_uuid] interfaces */
    0, /* Filler1 */
    0, /* Filler2 */
    0 /* Filler3 */
};

#endif /* !defined(_M_IA64) && !defined(_M_AXP64) */

#pragma warning( disable: 4049 ) /* more than 64k source lines */

/* this ALWAYS GENERATED file contains the proxy stub code */

/* File created by MIDL compiler version 5.03.0280 */
/* at Sat Apr 08 16:40:10 2000
*/
/* Compiler settings for .\src\tpcc_com_ps.idl:
Oicf (OptLev=12), W1, Zp8, env=Win64 (32b run,appending), ms_ext, c_ext, robust
error checks: allocation ref bounds_check enum stub_data
VC __declspec() decoration level:
__declspec(uuid()), __declspec(selectany), __declspec(novtable)
DECLSPEC_UUID(), MIDL_INTERFACE()
*/
```

Appendix A - Application Source Code

```
//@MIDL_FILE_HEADING( )

#if defined(_M_IA64) || defined(_M_XPP64)
#define USE_STUBLESS_PROXY

/* verify that the <rpcproxy.h> version is high enough to compile this file*/
#ifndef __REDQ_RPCPROXY_H_VERSION__
#define __REQUIRED_RPCPROXY_H_VERSION__ 475
#endif

#include "rpcproxy.h"
#ifndef __RPCPROXY_H_VERSION__
#error this stub requires an updated version of <rpcproxy.h>
#endif // __RPCPROXY_H_VERSION__

#include "tpcc_com_ps.h"

#define TYPE_FORMAT_STRING_SIZE 979
#define PROC_FORMAT_STRING_SIZE 253
#define TRANSMIT_AS_TABLE_SIZE 0
#define WIRE_MARSHAL_TABLE_SIZE 1

typedef struct _MIDL_TYPE_FORMAT_STRING
{
    short Pad;
    unsigned char Format[ TYPE_FORMAT_STRING_SIZE ];
} MIDL_TYPE_FORMAT_STRING;

typedef struct _MIDL_PROC_FORMAT_STRING
{
    short Pad;
    unsigned char Format[ PROC_FORMAT_STRING_SIZE ];
} MIDL_PROC_FORMAT_STRING;

extern const MIDL_TYPE_FORMAT_STRING __MIDL_TypeFormatString;
extern const MIDL_PROC_FORMAT_STRING __MIDL_ProcFormatString;

/* Standard interface: __MIDL_itf_tpcc_com_ps_0000, ver. 0.0,
   GUID={0x00000000,0x0000,0x0000,{0x00,0x00,0x00,0x00,0x00,0x00,0x00,0x00}} */

/* Object interface: IUnknown, ver. 0.0,
   GUID={0x00000000,0x0000,0x0000,{0xC0,0x00,0x00,0x00,0x00,0x00,0x00,0x46}} */

/* Object interface: ITPCC, ver. 0.0,
   GUID={0xFEE6AA2,0x84B1,0x11d2,{0xBA,0x47,0x00,0xC0,0x4F,0xBF,0xE0,0x8B}} */

extern const MIDL_STUB_DESC Object_StubDesc;

extern const MIDL_SERVER_INFO ITPCC_ServerInfo;

#pragma code_seg(".orpc")
static const unsigned short ITPCC_FormatStringOffsetTable[] =
{
    0,
```

```
44,
88,
132,
176,
220
};

static const MIDL_SERVER_INFO ITPCC_ServerInfo =
{
    &Object_StubDesc,
    0,
    __MIDL_ProcFormatString.Format,
    &ITPCC_FormatStringOffsetTable[-3],
    0,
    0,
    0,
    0
};

static const MIDL_STUBLESS_PROXY_INFO ITPCC_ProxyInfo =
{
    &Object_StubDesc,
    __MIDL_ProcFormatString.Format,
    &ITPCC_FormatStringOffsetTable[-3],
    0,
    0,
    0
};

CINTERFACE_PROXY_VTABLE(9) _ITPCCProxyVtbl =
{
    &ITPCC_ProxyInfo,
    &IID_ITPCC,
    IUnknown_QueryInterface_Proxy,
    IUnknown_AddRef_Proxy,
    IUnknown_Release_Proxy ,
    (void *)-1 /* ITPCC::NewOrder */ ,
    (void *)-1 /* ITPCC::Payment */ ,
    (void *)-1 /* ITPCC::Delivery */ ,
    (void *)-1 /* ITPCC::StockLevel */ ,
    (void *)-1 /* ITPCC::OrderStatus */ ,
    (void *)-1 /* ITPCC::CallSetComplete */
};

const CInterfaceStubVtbl _ITPCCStubVtbl =
{
    &IID_ITPCC,
    &ITPCC_ServerInfo,
    9,
    0, /* pure interpreted */
    CStdStubBuffer_METHODS
};

extern const USER_MARSHAL_ROUTINE_QUADRUPLE UserMarshalRoutines[ WIRE_MARSHAL_TABLE_SIZE
];

static const MIDL_STUB_DESC Object_StubDesc =
{
    0,
    NdrOleAllocate,
    NdrOleFree,
    0,
    0,
```

Appendix A - Application Source Code

```
0,
0,
0,
_MIDL_TypeFormatString.Format,
1, /* -error bounds_check flag */
0x50002, /* Ndr library version */
0,
0x5030118, /* MIDL Version 5.3.280 */
0,
UserMarshalRoutines,
0, /* notify & notify_flag routine table */
0x1, /* MIDL flag */
0, /* Reserved3 */
0, /* Reserved4 */
0 /* Reserved5 */
};

#pragma data_seg(".rdata")

static const USER_MARSHAL_ROUTINE_QUADRUPLE UserMarshalRoutines[ WIRE_MARSHAL_TABLE_SIZE
] =
{
    {
        VARIANT_UserSize
        ,VARIANT_UserMarshal
        ,VARIANT_UserUnmarshal
        ,VARIANT_UserFree
    }
};

#if !defined(__RPC_WIN64__)
#error Invalid build platform for this stub.
#endif

static const MIDL_PROC_FORMAT_STRING __MIDL_ProcFormatString =
{
    0,
    {
        /* Procedure NewOrder */

        0x33, /* FC_AUTO_HANDLE */
        0x6c, /* Old Flags: object, Oi2 */
        /* 2 */ NdrFcLong( 0x0 ), /* 0 */
        /* 6 */ NdrFcShort( 0x3 ), /* 3 */
        #ifndef _ALPHA_
        /* 8 */ NdrFcShort( 0x38 ), /* ia64 Stack size/offset = 56 */
        #else
        NdrFcShort( 0x30 ), /* axp64 Stack size/offset = 48 */
        #endif
        /* 10 */ NdrFcShort( 0x0 ), /* 0 */
        /* 12 */ NdrFcShort( 0x8 ), /* 8 */
        /* 14 */ 0x47, /* Oi2 Flags: srv must size, clt must size, has return,
has ext, */
        /* 16 */ 0xa, 0x3, /* 3 */
        /* 10 */ /* 10 */
        /* Ext Flags: new corr desc, clt corr
check, srv corr check, */
        /* 18 */ NdrFcShort( 0x20 ), /* 32 */
        /* 20 */ NdrFcShort( 0x20 ), /* 32 */

```

```
/* 22 */ NdrFcShort( 0x0 ), /* 0 */
/* 24 */ NdrFcShort( 0x0 ), /* 0 */

/* Parameter txn_in */

/* 26 */ NdrFcShort( 0x8b ), /* Flags: must size, must free, in, by val, */
#ifdef _ALPHA_
/* 28 */ NdrFcShort( 0x10 ), /* ia64 Stack size/offset = 16 */
#else
NdrFcShort( 0x8 ), /* axp64 Stack size/offset = 8 */
#endif
/* 30 */ NdrFcShort( 0x3b6 ), /* Type Offset=950 */

/* Parameter txn_out */

/* 32 */ NdrFcShort( 0x6113 ), /* Flags: must size, must free, out, simple ref,
srv alloc size=24 */
#ifdef _ALPHA_
/* 34 */ NdrFcShort( 0x28 ), /* ia64 Stack size/offset = 40 */
#else
NdrFcShort( 0x20 ), /* axp64 Stack size/offset = 32 */
#endif
/* 36 */ NdrFcShort( 0x3c8 ), /* Type Offset=968 */

/* Return value */

/* 38 */ NdrFcShort( 0x70 ), /* Flags: out, return, base type, */
#ifdef _ALPHA_
/* 40 */ NdrFcShort( 0x30 ), /* ia64 Stack size/offset = 48 */
#else
NdrFcShort( 0x28 ), /* axp64 Stack size/offset = 40 */
#endif
/* 42 */ 0x8, /* FC_LONG */
0x0, /* 0 */

/* Procedure Payment */

/* 44 */ 0x33, /* FC_AUTO_HANDLE */
0x6c, /* Old Flags: object, Oi2 */
/* 46 */ NdrFcLong( 0x0 ), /* 0 */
/* 50 */ NdrFcShort( 0x4 ), /* 4 */
#ifdef _ALPHA_
/* 52 */ NdrFcShort( 0x38 ), /* ia64 Stack size/offset = 56 */
#else
NdrFcShort( 0x30 ), /* axp64 Stack size/offset = 48 */
#endif
/* 54 */ NdrFcShort( 0x0 ), /* 0 */
/* 56 */ NdrFcShort( 0x8 ), /* 8 */
/* 58 */ 0x47, /* Oi2 Flags: srv must size, clt must size, has return,
has ext, */
/* 60 */ 0xa, 0x3, /* 3 */
/* 10 */ /* 10 */
/* Ext Flags: new corr desc, clt corr
check, srv corr check, */
/* 62 */ NdrFcShort( 0x20 ), /* 32 */
/* 64 */ NdrFcShort( 0x20 ), /* 32 */
/* 66 */ NdrFcShort( 0x0 ), /* 0 */
/* 68 */ NdrFcShort( 0x0 ), /* 0 */

/* Parameter txn_in */

/* 70 */ NdrFcShort( 0x8b ), /* Flags: must size, must free, in, by val, */
#ifdef _ALPHA_

```

Appendix A - Application Source Code

```
/* 72 */ NdrFcShort( 0x10 ), /* ia64 Stack size/offset = 16 */
#else
                NdrFcShort( 0x8 ), /* axp64 Stack size/offset = 8 */
#endif
/* 74 */ NdrFcShort( 0x3b6 ), /* Type Offset=950 */

        /* Parameter txn_out */

/* 76 */ NdrFcShort( 0x6113 ), /* Flags: must size, must free, out, simple ref,
srv alloc size=24 */
#ifndef _ALPHA_
/* 78 */ NdrFcShort( 0x28 ), /* ia64 Stack size/offset = 40 */
#else
                NdrFcShort( 0x20 ), /* axp64 Stack size/offset = 32 */
#endif
/* 80 */ NdrFcShort( 0x3c8 ), /* Type Offset=968 */

        /* Return value */

/* 82 */ NdrFcShort( 0x70 ), /* Flags: out, return, base type, */
#ifndef _ALPHA_
/* 84 */ NdrFcShort( 0x30 ), /* ia64 Stack size/offset = 48 */
#else
                NdrFcShort( 0x28 ), /* axp64 Stack size/offset = 40 */
#endif
/* 86 */ 0x8, /* FC_LONG */
        0x0, /* 0 */

        /* Procedure Delivery */

/* 88 */ 0x33, /* FC_AUTO_HANDLE */
        0x6c, /* Old Flags: object, Oi2 */

/* 90 */ NdrFcLong( 0x0 ), /* 0 */
/* 94 */ NdrFcShort( 0x5 ), /* 5 */
#ifndef _ALPHA_
/* 96 */ NdrFcShort( 0x38 ), /* ia64 Stack size/offset = 56 */
#else
                NdrFcShort( 0x30 ), /* axp64 Stack size/offset = 48 */
#endif
/* 98 */ NdrFcShort( 0x0 ), /* 0 */
/* 100 */ NdrFcShort( 0x8 ), /* 8 */
/* 102 */ 0x47, /* Oi2 Flags: srv must size, clt must size, has return,
has ext, */
        0x3, /* 3 */
/* 104 */ 0xa, /* 10 */
        0x7, /* Ext Flags: new corr desc, clt corr
check, srv corr check, */
/* 106 */ NdrFcShort( 0x20 ), /* 32 */
/* 108 */ NdrFcShort( 0x20 ), /* 32 */
/* 110 */ NdrFcShort( 0x0 ), /* 0 */
/* 112 */ NdrFcShort( 0x0 ), /* 0 */

        /* Parameter txn_in */

/* 114 */ NdrFcShort( 0x8b ), /* Flags: must size, must free, in, by val, */
#ifndef _ALPHA_
/* 116 */ NdrFcShort( 0x10 ), /* ia64 Stack size/offset = 16 */
#else
                NdrFcShort( 0x8 ), /* axp64 Stack size/offset = 8 */
#endif
/* 118 */ NdrFcShort( 0x3b6 ), /* Type Offset=950 */

        /* Parameter txn_out */
```

```
/* 120 */ NdrFcShort( 0x6113 ), /* Flags: must size, must free, out, simple ref,
srv alloc size=24 */
#ifndef _ALPHA_
/* 122 */ NdrFcShort( 0x28 ), /* ia64 Stack size/offset = 40 */
#else
                NdrFcShort( 0x20 ), /* axp64 Stack size/offset = 32 */
#endif
/* 124 */ NdrFcShort( 0x3c8 ), /* Type Offset=968 */

        /* Return value */

/* 126 */ NdrFcShort( 0x70 ), /* Flags: out, return, base type, */
#ifndef _ALPHA_
/* 128 */ NdrFcShort( 0x30 ), /* ia64 Stack size/offset = 48 */
#else
                NdrFcShort( 0x28 ), /* axp64 Stack size/offset = 40 */
#endif
/* 130 */ 0x8, /* FC_LONG */
        0x0, /* 0 */

        /* Procedure StockLevel */

/* 132 */ 0x33, /* FC_AUTO_HANDLE */
        0x6c, /* Old Flags: object, Oi2 */

/* 134 */ NdrFcLong( 0x0 ), /* 0 */
/* 138 */ NdrFcShort( 0x6 ), /* 6 */
#ifndef _ALPHA_
/* 140 */ NdrFcShort( 0x38 ), /* ia64 Stack size/offset = 56 */
#else
                NdrFcShort( 0x30 ), /* axp64 Stack size/offset = 48 */
#endif
/* 142 */ NdrFcShort( 0x0 ), /* 0 */
/* 144 */ NdrFcShort( 0x8 ), /* 8 */
/* 146 */ 0x47, /* Oi2 Flags: srv must size, clt must size, has return,
has ext, */
        0x3, /* 3 */
/* 148 */ 0xa, /* 10 */
        0x7, /* Ext Flags: new corr desc, clt corr
check, srv corr check, */
/* 150 */ NdrFcShort( 0x20 ), /* 32 */
/* 152 */ NdrFcShort( 0x20 ), /* 32 */
/* 154 */ NdrFcShort( 0x0 ), /* 0 */
/* 156 */ NdrFcShort( 0x0 ), /* 0 */

        /* Parameter txn_in */

/* 158 */ NdrFcShort( 0x8b ), /* Flags: must size, must free, in, by val, */
#ifndef _ALPHA_
/* 160 */ NdrFcShort( 0x10 ), /* ia64 Stack size/offset = 16 */
#else
                NdrFcShort( 0x8 ), /* axp64 Stack size/offset = 8 */
#endif
/* 162 */ NdrFcShort( 0x3b6 ), /* Type Offset=950 */

        /* Parameter txn_out */

/* 164 */ NdrFcShort( 0x6113 ), /* Flags: must size, must free, out, simple ref,
srv alloc size=24 */
#ifndef _ALPHA_
/* 166 */ NdrFcShort( 0x28 ), /* ia64 Stack size/offset = 40 */
#else
                NdrFcShort( 0x20 ), /* axp64 Stack size/offset = 32 */
```

Appendix A - Application Source Code

```
#endif
/* 168 */ NdrFcShort( 0x3c8 ), /* Type Offset=968 */

/* Return value */

/* 170 */ NdrFcShort( 0x70 ), /* Flags: out, return, base type, */
#ifdef _ALPHA_
/* 172 */ NdrFcShort( 0x30 ), /* ia64 Stack size/offset = 48 */
#else
NdrFcShort( 0x28 ), /* axp64 Stack size/offset = 40 */
#endif
/* 174 */ 0x8, /* FC_LONG */
0x0, /* 0 */

/* Procedure OrderStatus */

/* 176 */ 0x33, /* FC_AUTO_HANDLE */
0x6c, /* Old Flags: object, Oi2 */
/* 178 */ NdrFcLong( 0x0 ), /* 0 */
/* 182 */ NdrFcShort( 0x7 ), /* 7 */
#ifdef _ALPHA_
/* 184 */ NdrFcShort( 0x38 ), /* ia64 Stack size/offset = 56 */
#else
NdrFcShort( 0x30 ), /* axp64 Stack size/offset = 48 */
#endif
/* 186 */ NdrFcShort( 0x0 ), /* 0 */
/* 188 */ NdrFcShort( 0x8 ), /* 8 */
/* 190 */ 0x47, /* Oi2 Flags: srv must size, clt must size, has return,
has ext, */
0x3, /* 3 */
/* 192 */ 0xa, /* 10 */
0x7, /* Ext Flags: new corr desc, clt corr
check, srv corr check, */
/* 194 */ NdrFcShort( 0x20 ), /* 32 */
/* 196 */ NdrFcShort( 0x20 ), /* 32 */
/* 198 */ NdrFcShort( 0x0 ), /* 0 */
/* 200 */ NdrFcShort( 0x0 ), /* 0 */

/* Parameter txn_in */

/* 202 */ NdrFcShort( 0x8b ), /* Flags: must size, must free, in, by val, */
#ifdef _ALPHA_
/* 204 */ NdrFcShort( 0x10 ), /* ia64 Stack size/offset = 16 */
#else
NdrFcShort( 0x8 ), /* axp64 Stack size/offset = 8 */
#endif
/* 206 */ 0x3b6, /* Type Offset=950 */

/* Parameter txn_out */

/* 208 */ NdrFcShort( 0x6113 ), /* Flags: must size, must free, out, simple ref,
srv alloc size=24 */
#ifdef _ALPHA_
/* 210 */ NdrFcShort( 0x28 ), /* ia64 Stack size/offset = 40 */
#else
NdrFcShort( 0x20 ), /* axp64 Stack size/offset = 32 */
#endif
/* 212 */ NdrFcShort( 0x3c8 ), /* Type Offset=968 */

/* Return value */

/* 214 */ NdrFcShort( 0x70 ), /* Flags: out, return, base type, */
#ifdef _ALPHA_
```

```
/* 216 */ NdrFcShort( 0x30 ), /* ia64 Stack size/offset = 48 */
#else
NdrFcShort( 0x28 ), /* axp64 Stack size/offset = 40 */
#endif
/* 218 */ 0x8, /* FC_LONG */
0x0, /* 0 */

/* Procedure CallSetComplete */

/* 220 */ 0x33, /* FC_AUTO_HANDLE */
0x6c, /* Old Flags: object, Oi2 */
/* 222 */ NdrFcLong( 0x0 ), /* 0 */
/* 226 */ NdrFcShort( 0x8 ), /* 8 */
/* 228 */ NdrFcShort( 0x10 ), /* ia64, axp64 Stack size/offset = 16 */
/* 230 */ NdrFcShort( 0x0 ), /* 0 */
/* 232 */ NdrFcShort( 0x8 ), /* 8 */
/* 234 */ 0x44, /* Oi2 Flags: has return, has ext, */
0x1, /* 1 */
/* 236 */ 0xa, /* 10 */
0x1, /* Ext Flags: new corr desc, */
/* 238 */ NdrFcShort( 0x0 ), /* 0 */
/* 240 */ NdrFcShort( 0x0 ), /* 0 */
/* 242 */ NdrFcShort( 0x0 ), /* 0 */
/* 244 */ NdrFcShort( 0x0 ), /* 0 */

/* Return value */

/* 246 */ NdrFcShort( 0x70 ), /* Flags: out, return, base type, */
/* 248 */ NdrFcShort( 0x8 ), /* ia64, axp64 Stack size/offset = 8 */
/* 250 */ 0x8, /* FC_LONG */
0x0, /* 0 */

0x0

}
};

static const MIDL_TYPE_FORMAT_STRING __MIDL_TypeFormatString =
{
0,
{
/* 2 */ NdrFcShort( 0x0 ), /* 0 */
/* 4 */ NdrFcShort( 0x39e ), /* Offset= 926 (930) */
/* 6 */
0x2b, /* FC_NON_ENCAPSULATED_UNION */
0x9, /* FC_ULONG */
/* 8 */ 0x7, /* Corr desc: FC_USHORT */
0x0, /* */
/* 10 */ NdrFcShort( 0xffff8 ), /* -8 */
/* 12 */ NdrFcShort( 0x1 ), /* Corr flags: early, */
/* 14 */ NdrFcShort( 0x2 ), /* Offset= 2 (16) */
/* 16 */ NdrFcShort( 0x10 ), /* 16 */
/* 18 */ NdrFcShort( 0x2b ), /* 43 */
/* 20 */ NdrFcLong( 0x3 ), /* 3 */
/* 24 */ NdrFcShort( 0x8008 ), /* Simple arm type: FC_LONG */
/* 26 */ NdrFcLong( 0x11 ), /* 17 */
/* 30 */ NdrFcShort( 0x8001 ), /* Simple arm type: FC_BYTE */
/* 32 */ NdrFcLong( 0x2 ), /* 2 */
/* 36 */ NdrFcShort( 0x8006 ), /* Simple arm type: FC_SHORT */
/* 38 */ NdrFcLong( 0x4 ), /* 4 */
/* 42 */ NdrFcShort( 0x800a ), /* Simple arm type: FC_FLOAT */
/* 44 */ NdrFcLong( 0x5 ), /* 5 */
```

Appendix A - Application Source Code

```
/* 48 */ NdrFcShort( 0x800c ), /* Simple arm type: FC_DOUBLE */
/* 50 */ NdrFcLong( 0xb ), /* 11 */
/* 54 */ NdrFcShort( 0x8006 ), /* Simple arm type: FC_SHORT */
/* 56 */ NdrFcLong( 0xa ), /* 10 */
/* 60 */ NdrFcShort( 0x8008 ), /* Simple arm type: FC_LONG */
/* 62 */ NdrFcLong( 0x6 ), /* 6 */
/* 66 */ NdrFcShort( 0xd6 ), /* Offset= 214 (280) */
/* 68 */ NdrFcLong( 0x7 ), /* 7 */
/* 72 */ NdrFcShort( 0x800c ), /* Simple arm type: FC_DOUBLE */
/* 74 */ NdrFcLong( 0x8 ), /* 8 */
/* 78 */ NdrFcShort( 0xd0 ), /* Offset= 208 (286) */
/* 80 */ NdrFcLong( 0xd ), /* 13 */
/* 84 */ NdrFcShort( 0xe4 ), /* Offset= 228 (312) */
/* 86 */ NdrFcLong( 0x9 ), /* 9 */
/* 90 */ NdrFcShort( 0xf0 ), /* Offset= 240 (330) */
/* 92 */ NdrFcLong( 0x2000 ), /* 8192 */
/* 96 */ NdrFcShort( 0xfc ), /* Offset= 252 (348) */
/* 98 */ NdrFcLong( 0x24 ), /* 36 */
/* 102 */ NdrFcShort( 0x2f4 ), /* Offset= 756 (858) */
/* 104 */ NdrFcLong( 0x4024 ), /* 16420 */
/* 108 */ NdrFcShort( 0x2ee ), /* Offset= 750 (858) */
/* 110 */ NdrFcLong( 0x4011 ), /* 16401 */
/* 114 */ NdrFcShort( 0x2ec ), /* Offset= 748 (862) */
/* 116 */ NdrFcLong( 0x4002 ), /* 16386 */
/* 120 */ NdrFcShort( 0x2ea ), /* Offset= 746 (866) */
/* 122 */ NdrFcLong( 0x4003 ), /* 16387 */
/* 126 */ NdrFcShort( 0x2e8 ), /* Offset= 744 (870) */
/* 128 */ NdrFcLong( 0x4004 ), /* 16388 */
/* 132 */ NdrFcShort( 0x2e6 ), /* Offset= 742 (874) */
/* 134 */ NdrFcLong( 0x4005 ), /* 16389 */
/* 138 */ NdrFcShort( 0x2e4 ), /* Offset= 740 (878) */
/* 140 */ NdrFcLong( 0x400b ), /* 16395 */
/* 144 */ NdrFcShort( 0x2d2 ), /* Offset= 722 (866) */
/* 146 */ NdrFcLong( 0x400a ), /* 16394 */
/* 150 */ NdrFcShort( 0x2d0 ), /* Offset= 720 (870) */
/* 152 */ NdrFcLong( 0x4006 ), /* 16390 */
/* 156 */ NdrFcShort( 0x2d6 ), /* Offset= 726 (882) */
/* 158 */ NdrFcLong( 0x4007 ), /* 16391 */
/* 162 */ NdrFcShort( 0x2cc ), /* Offset= 716 (878) */
/* 164 */ NdrFcLong( 0x4008 ), /* 16392 */
/* 168 */ NdrFcShort( 0x2ce ), /* Offset= 718 (886) */
/* 170 */ NdrFcLong( 0x400d ), /* 16397 */
/* 174 */ NdrFcShort( 0x2cc ), /* Offset= 716 (890) */
/* 176 */ NdrFcLong( 0x4009 ), /* 16393 */
/* 180 */ NdrFcShort( 0x2ca ), /* Offset= 714 (894) */
/* 182 */ NdrFcLong( 0x6000 ), /* 24576 */
/* 186 */ NdrFcShort( 0x2c8 ), /* Offset= 712 (898) */
/* 188 */ NdrFcLong( 0x400c ), /* 16396 */
/* 192 */ NdrFcShort( 0x2c6 ), /* Offset= 710 (902) */
/* 194 */ NdrFcLong( 0x10 ), /* 16 */
/* 198 */ NdrFcShort( 0x8002 ), /* Simple arm type: FC_CHAR */
/* 200 */ NdrFcLong( 0x12 ), /* 18 */
/* 204 */ NdrFcShort( 0x8006 ), /* Simple arm type: FC_SHORT */
/* 206 */ NdrFcLong( 0x13 ), /* 19 */
/* 210 */ NdrFcShort( 0x8008 ), /* Simple arm type: FC_LONG */
/* 212 */ NdrFcLong( 0x16 ), /* 22 */
/* 216 */ NdrFcShort( 0x8008 ), /* Simple arm type: FC_LONG */
/* 218 */ NdrFcLong( 0x17 ), /* 23 */
/* 222 */ NdrFcShort( 0x8008 ), /* Simple arm type: FC_LONG */
/* 224 */ NdrFcLong( 0xe ), /* 14 */
/* 228 */ NdrFcShort( 0x2aa ), /* Offset= 682 (910) */
/* 230 */ NdrFcLong( 0x400e ), /* 16398 */
/* 234 */ NdrFcShort( 0x2b0 ), /* Offset= 688 (922) */

/* 236 */ NdrFcLong( 0x4010 ), /* 16400 */
/* 240 */ NdrFcShort( 0x2ae ), /* Offset= 686 (926) */
/* 242 */ NdrFcLong( 0x4012 ), /* 16402 */
/* 246 */ NdrFcShort( 0x26c ), /* Offset= 620 (866) */
/* 248 */ NdrFcLong( 0x4013 ), /* 16403 */
/* 252 */ NdrFcShort( 0x26a ), /* Offset= 618 (870) */
/* 254 */ NdrFcLong( 0x4016 ), /* 16406 */
/* 258 */ NdrFcShort( 0x264 ), /* Offset= 612 (870) */
/* 260 */ NdrFcLong( 0x4017 ), /* 16407 */
/* 264 */ NdrFcShort( 0x25e ), /* Offset= 606 (870) */
/* 266 */ NdrFcLong( 0x0 ), /* 0 */
/* 270 */ NdrFcShort( 0x0 ), /* Offset= 0 (270) */
/* 272 */ NdrFcLong( 0x1 ), /* 1 */
/* 276 */ NdrFcShort( 0x0 ), /* Offset= 0 (276) */
/* 278 */ NdrFcShort( 0xffffffff ), /* Offset= -1 (277) */
/* 280 */

/* 282 */ NdrFcShort( 0x8 ), /* 8 */
/* 284 */ 0xb, /* FC_HYPER */
/* 286 */ 0x5b, /* FC_END */

/* 288 */ NdrFcShort( 0xe ), /* FC_UP */
/* 290 */ 0x12, 0x0, /* Offset= 14 (302) */

/* 292 */ NdrFcShort( 0x2 ), /* 2 */
/* 294 */ 0x9, /* Corr desc: FC_ULONG */
/* 296 */ 0x0, /* -4 */
/* 298 */ NdrFcShort( 0x1 ), /* Corr flags: early, */
/* 300 */ 0x6, /* FC_SHORT */
/* 302 */ 0x5b, /* FC_END */

/* 304 */ NdrFcShort( 0x8 ), /* 8 */
/* 306 */ NdrFcShort( 0xffffffff0 ), /* Offset= -16 (290) */
/* 308 */ 0x8, /* FC_LONG */
/* 310 */ 0x5c, /* FC_PAD */
/* 312 */ 0x5b, /* FC_END */

/* 314 */ NdrFcLong( 0x2E, /* FC_IP */
/* 316 */ 0x5a, /* FC_CONSTANT_IID */
/* 318 */ 0x0 ), /* 0 */
/* 320 */ NdrFcShort( 0x0 ), /* 0 */
/* 322 */ 0xc0, /* 192 */
/* 324 */ 0x0, /* 0 */
/* 326 */ 0x0, /* 0 */
/* 328 */ 0x0, /* 0 */
/* 330 */ 0x0, /* 0 */
/* 332 */ 0x46, /* 70 */
/* 334 */ 0x2E, /* FC_IP */
/* 336 */ 0x5a, /* FC_CONSTANT_IID */
/* 338 */ 0x0 ), /* 132096 */
/* 340 */ NdrFcLong( 0x20400 ), /* 132096 */
/* 342 */ NdrFcShort( 0x0 ), /* 0 */
/* 344 */ NdrFcShort( 0x0 ), /* 0 */
```

Appendix A - Application Source Code

```
/* 340 */ 0xc0, /* 192 */
/* 342 */ 0x0, /* 0 */
/* 344 */ 0x0, /* 0 */
/* 346 */ 0x0, /* 0 */
/* 348 */ 0x46, /* 70 */
/* 350 */ NdrFcShort( 0x2 ), /* FC_UP [pointer_deref] */
/* 352 */ /* Offset= 2 (352) */
/* 354 */ NdrFcShort( 0x1e6 ), /* FC_UP */
/* 356 */ /* Offset= 486 (840) */
/* 358 */ 0x2a, /* FC_ENCAPSULATED_UNION */
/* 360 */ 0x89, /* 137 */
/* 362 */ NdrFcShort( 0x20 ), /* 32 */
/* 364 */ NdrFcShort( 0xa ), /* 10 */
/* 366 */ NdrFcLong( 0x8 ), /* 8 */
/* 368 */ NdrFcShort( 0x50 ), /* Offset= 80 (446) */
/* 370 */ NdrFcLong( 0xd ), /* 13 */
/* 372 */ NdrFcShort( 0x70 ), /* Offset= 112 (484) */
/* 374 */ NdrFcLong( 0x9 ), /* 9 */
/* 376 */ NdrFcShort( 0x90 ), /* Offset= 144 (522) */
/* 378 */ NdrFcLong( 0xc ), /* 12 */
/* 380 */ NdrFcShort( 0xb0 ), /* Offset= 176 (560) */
/* 382 */ NdrFcLong( 0x24 ), /* 36 */
/* 384 */ NdrFcShort( 0x104 ), /* Offset= 260 (650) */
/* 386 */ NdrFcLong( 0x800d ), /* 32781 */
/* 388 */ NdrFcShort( 0x120 ), /* Offset= 288 (684) */
/* 390 */ NdrFcLong( 0x10 ), /* 16 */
/* 392 */ NdrFcShort( 0x13a ), /* Offset= 314 (716) */
/* 394 */ NdrFcLong( 0x2 ), /* 2 */
/* 396 */ NdrFcShort( 0x150 ), /* Offset= 336 (744) */
/* 398 */ NdrFcLong( 0x3 ), /* 3 */
/* 400 */ NdrFcShort( 0x166 ), /* Offset= 358 (772) */
/* 402 */ NdrFcLong( 0x14 ), /* 20 */
/* 404 */ NdrFcShort( 0x17c ), /* Offset= 380 (800) */
/* 406 */ NdrFcShort( 0xfffffff ), /* Offset= -1 (421) */
/* 408 */
/* 410 */ 0x21, /* FC_BOGUS_ARRAY */
/* 412 */ 0x3, /* 3 */
/* 414 */ NdrFcShort( 0x0 ), /* 0 */
/* 416 */ 0x19, /* Corr desc: field pointer, FC_ULONG */
/* 418 */ 0x0, /* */
/* 420 */ NdrFcShort( 0x0 ), /* 0 */
/* 422 */ NdrFcShort( 0x1 ), /* Corr flags: early, */
/* 424 */ NdrFcLong( 0xfffffff ), /* -1 */
/* 426 */ NdrFcShort( 0x0 ), /* Corr flags: */
/* 428 */ 0x4c, /* FC_EMBEDDED_COMPLEX */
/* 430 */ 0x0, /* 0 */
/* 432 */ NdrFcShort( 0xfffffff4 ), /* Offset= -140 (302) */
/* 434 */ 0x5c, /* FC_PAD */
/* 436 */ 0x5b, /* FC_END */
/* 438 */
/* 440 */ 0x1a, /* FC_BOGUS_STRUCT */
/* 442 */ 0x3, /* 3 */
/* 444 */ NdrFcShort( 0x10 ), /* 16 */
/* 446 */ NdrFcShort( 0x0 ), /* 0 */
/* 448 */ NdrFcShort( 0x6 ), /* Offset= 6 (458) */
/* 450 */ 0x8, /* FC_LONG */
/* 452 */ 0x39, /* FC_ALIGNM8 */
/* 454 */ 0x36, /* FC_POINTER */
/* 456 */ 0x5b, /* FC_END */
/* 458 */
/* 460 */ NdrFcShort( 0xfffffddc ), /* FC_RP */
/* 462 */ /* Offset= -36 (424) */
/* 464 */ 0x21, /* FC_BOGUS_ARRAY */
/* 466 */ 0x3, /* 3 */
/* 468 */ NdrFcShort( 0x0 ), /* 0 */
/* 470 */ 0x19, /* Corr desc: field pointer, FC_ULONG */
/* 472 */ 0x0, /* */
/* 474 */ NdrFcShort( 0x0 ), /* 0 */
/* 476 */ 0x1, /* Corr flags: early, */
/* 478 */ NdrFcLong( 0xfffffff ), /* -1 */
/* 480 */ NdrFcShort( 0x0 ), /* Corr flags: */
/* 482 */ 0x4c, /* FC_EMBEDDED_COMPLEX */
/* 484 */ 0x0, /* 0 */
/* 486 */ NdrFcShort( 0xfffffff58 ), /* Offset= -168 (312) */
/* 488 */ 0x5c, /* FC_PAD */
/* 490 */ 0x5b, /* FC_END */
/* 492 */
/* 494 */ 0x1a, /* FC_BOGUS_STRUCT */
/* 496 */ 0x3, /* 3 */
/* 498 */ NdrFcShort( 0x10 ), /* 16 */
/* 500 */ NdrFcShort( 0x0 ), /* 0 */
/* 502 */ NdrFcShort( 0x6 ), /* Offset= 6 (496) */
/* 504 */ 0x8, /* FC_LONG */
/* 506 */ 0x39, /* FC_ALIGNM8 */
/* 508 */ 0x36, /* FC_POINTER */
/* 510 */ 0x5b, /* FC_END */
/* 512 */
/* 514 */ 0x11, 0x0, /* FC_RP */
/* 516 */ NdrFcShort( 0xfffffddc ), /* Offset= -36 (462) */
/* 518 */ 0x21, /* FC_BOGUS_ARRAY */
/* 520 */ 0x3, /* 3 */
/* 522 */ NdrFcShort( 0x0 ), /* 0 */
/* 524 */ 0x19, /* Corr desc: field pointer, FC_ULONG */
/* 526 */ 0x0, /* */
/* 528 */ NdrFcShort( 0x0 ), /* 0 */
/* 530 */ 0x1, /* Corr flags: early, */
/* 532 */ NdrFcLong( 0xfffffff ), /* -1 */
/* 534 */ NdrFcShort( 0x0 ), /* Corr flags: */
/* 536 */ 0x4c, /* FC_EMBEDDED_COMPLEX */
/* 538 */ 0x0, /* 0 */
/* 540 */ NdrFcShort( 0xfffffff44 ), /* Offset= -188 (330) */
/* 542 */ 0x5c, /* FC_PAD */
/* 544 */ 0x5b, /* FC_END */
/* 546 */
/* 548 */ 0x1a, /* FC_BOGUS_STRUCT */
/* 550 */ 0x3, /* 3 */
/* 552 */ NdrFcShort( 0x10 ), /* 16 */
/* 554 */ NdrFcShort( 0x0 ), /* 0 */
/* 556 */ NdrFcShort( 0x6 ), /* Offset= 6 (534) */
/* 558 */ 0x8, /* FC_LONG */
/* 560 */ 0x39, /* FC_ALIGNM8 */
/* 562 */ 0x36, /* FC_POINTER */
/* 564 */ 0x5b, /* FC_END */
/* 566 */
/* 568 */ 0x11, 0x0, /* FC_RP */
/* 570 */ NdrFcShort( 0xfffffddc ), /* Offset= -36 (500) */
/* 572 */ 0x21, /* FC_BOGUS_ARRAY */
```

Appendix A - Application Source Code

```
0x3, /* 3 */
/* 540 */ NdrFcShort( 0x0 ), /* 0 */
/* 542 */ 0x19, /* Corr desc: field pointer, FC_ULONG */
0x0, /* */
/* 544 */ NdrFcShort( 0x0 ), /* 0 */
/* 546 */ NdrFcShort( 0x1 ), /* Corr flags: early, */
/* 548 */ NdrFcLong( 0xffffffff ), /* -1 */
/* 552 */ NdrFcShort( 0x0 ), /* Corr flags: */
/* 554 */
0x12, 0x0, /* FC_UP */
/* 556 */ NdrFcShort( 0x176 ), /* Offset= 374 (930) */
/* 558 */ 0x5c, /* FC_PAD */
0x5b, /* FC_END */
/* 560 */
0x1a, /* FC_BOGUS_STRUCT */
0x3, /* 3 */
/* 562 */ NdrFcShort( 0x10 ), /* 16 */
/* 564 */ NdrFcShort( 0x0 ), /* 0 */
/* 566 */ NdrFcShort( 0x6 ), /* Offset= 6 (572) */
/* 568 */ 0x8, /* FC_LONG */
0x39, /* FC_ALIGNM8 */
/* 570 */ 0x36, /* FC_POINTER */
0x5b, /* FC_END */
/* 572 */
0x11, 0x0, /* FC_RP */
/* 574 */ NdrFcShort( 0xffffffffc ), /* Offset= -36 (538) */
/* 576 */
0x2f, /* FC_IP */
0x5a, /* FC_CONSTANT_IID */
/* 578 */ NdrFcLong( 0x2f ), /* 47 */
/* 582 */ NdrFcShort( 0x0 ), /* 0 */
/* 584 */ NdrFcShort( 0x0 ), /* 0 */
/* 586 */ 0xc0, /* 192 */
0x0, /* 0 */
/* 588 */ 0x0, /* 0 */
0x0, /* 0 */
/* 590 */ 0x0, /* 0 */
0x0, /* 0 */
/* 592 */ 0x0, /* 0 */
0x46, /* 70 */
/* 594 */
0x1b, /* FC_CARRAY */
0x0, /* 0 */
/* 596 */ NdrFcShort( 0x1 ), /* 1 */
/* 598 */ 0x19, /* Corr desc: field pointer, FC_ULONG */
0x0, /* */
/* 600 */ NdrFcShort( 0x4 ), /* 4 */
/* 602 */ NdrFcShort( 0x1 ), /* Corr flags: early, */
/* 604 */ 0x1, /* FC_BYTE */
0x5b, /* FC_END */
/* 606 */
0x1a, /* FC_BOGUS_STRUCT */
0x3, /* 3 */
/* 608 */ NdrFcShort( 0x18 ), /* 24 */
/* 610 */ NdrFcShort( 0x0 ), /* 0 */
/* 612 */ NdrFcShort( 0xc ), /* Offset= 12 (624) */
/* 614 */ 0x8, /* FC_LONG */
0x8, /* FC_LONG */
/* 616 */ 0x4c, /* FC_EMBEDDED_COMPLEX */
0x0, /* 0 */
/* 618 */ NdrFcShort( 0xfffffd6 ), /* Offset= -42 (576) */
/* 620 */ 0x39, /* FC_ALIGNM8 */
0x36, /* FC_POINTER */
```

```
/* 622 */ 0x5c, /* FC_PAD */
0x5b, /* FC_END */
/* 624 */
0x12, 0x0, /* FC_UP */
/* 626 */ NdrFcShort( 0xffffffffe0 ), /* Offset= -32 (594) */
/* 628 */
0x21, /* FC_BOGUS_ARRAY */
0x3, /* 3 */
/* 630 */ NdrFcShort( 0x0 ), /* 0 */
/* 632 */ 0x19, /* Corr desc: field pointer, FC_ULONG */
0x0, /* */
/* 634 */ NdrFcShort( 0x0 ), /* 0 */
/* 636 */ NdrFcShort( 0x1 ), /* Corr flags: early, */
/* 638 */ NdrFcLong( 0xffffffff ), /* -1 */
/* 642 */ NdrFcShort( 0x0 ), /* Corr flags: */
/* 644 */
0x12, 0x0, /* FC_UP */
/* 646 */ NdrFcShort( 0xfffffd8 ), /* Offset= -40 (606) */
/* 648 */ 0x5c, /* FC_PAD */
0x5b, /* FC_END */
/* 650 */
0x1a, /* FC_BOGUS_STRUCT */
0x3, /* 3 */
/* 652 */ NdrFcShort( 0x10 ), /* 16 */
/* 654 */ NdrFcShort( 0x0 ), /* 0 */
/* 656 */ NdrFcShort( 0x6 ), /* Offset= 6 (662) */
/* 658 */ 0x8, /* FC_LONG */
0x39, /* FC_ALIGNM8 */
/* 660 */ 0x36, /* FC_POINTER */
0x5b, /* FC_END */
/* 662 */
0x11, 0x0, /* FC_RP */
/* 664 */ NdrFcShort( 0xffffffffc ), /* Offset= -36 (628) */
/* 666 */
0x1d, /* FC_SMFARRAY */
0x0, /* 0 */
/* 668 */ NdrFcShort( 0x8 ), /* 8 */
/* 670 */ 0x2, /* FC_CHAR */
0x5b, /* FC_END */
/* 672 */
0x15, /* FC_STRUCT */
0x3, /* 3 */
/* 674 */ NdrFcShort( 0x10 ), /* 16 */
/* 676 */ 0x8, /* FC_LONG */
0x6, /* FC_SHORT */
/* 678 */ 0x6, /* FC_SHORT */
0x4c, /* FC_EMBEDDED_COMPLEX */
/* 680 */ 0x0, /* 0 */
NdrFcShort( 0xfffffffff1 ), /* Offset= -15 (666) */
0x5b, /* FC_END */
/* 684 */
0x1a, /* FC_BOGUS_STRUCT */
0x3, /* 3 */
/* 686 */ NdrFcShort( 0x20 ), /* 32 */
/* 688 */ NdrFcShort( 0x0 ), /* 0 */
/* 690 */ NdrFcShort( 0xa ), /* Offset= 10 (700) */
/* 692 */ 0x8, /* FC_LONG */
0x39, /* FC_ALIGNM8 */
/* 694 */ 0x36, /* FC_POINTER */
0x4c, /* FC_EMBEDDED_COMPLEX */
/* 696 */ 0x0, /* 0 */
NdrFcShort( 0xfffffe7 ), /* Offset= -25 (672) */
0x5b, /* FC_END */
```

Appendix A - Application Source Code

```
/* 700 */
                                0x11, 0x0,          /* FC_RP */
/* 702 */ NdrFcShort( 0xffffffff10 ), /* Offset= -240 (462) */
/* 704 */
                                0x1b,          /* FC_CARRAY */
                                0x0,          /* 0 */
/* 706 */ NdrFcShort( 0x1 ), /* 1 */
/* 708 */ 0x19, /* Corr desc: field pointer, FC_ULONG */
                                0x0,          /* */
/* 710 */ NdrFcShort( 0x0 ), /* 0 */
/* 712 */ NdrFcShort( 0x1 ), /* Corr flags: early, */
/* 714 */ 0x1, /* FC_BYTE */
                                0x5b,          /* FC_END */
/* 716 */
                                0x1a,          /* FC_BOGUS_STRUCT */
                                0x3,          /* 3 */
/* 718 */ NdrFcShort( 0x10 ), /* 16 */
/* 720 */ NdrFcShort( 0x0 ), /* 0 */
/* 722 */ NdrFcShort( 0x6 ), /* Offset= 6 (728) */
/* 724 */ 0x8, /* FC_LONG */
                                0x39,          /* FC_ALIGNM8 */
/* 726 */ 0x36, /* FC_POINTER */
                                0x5b,          /* FC_END */
/* 728 */
                                0x12, 0x0,          /* FC_UP */
/* 730 */ NdrFcShort( 0xffffffffe6 ), /* Offset= -26 (704) */
/* 732 */
                                0x1b,          /* FC_CARRAY */
                                0x1,          /* 1 */
/* 734 */ NdrFcShort( 0x2 ), /* 2 */
/* 736 */ 0x19, /* Corr desc: field pointer, FC_ULONG */
                                0x0,          /* */
/* 738 */ NdrFcShort( 0x0 ), /* 0 */
/* 740 */ NdrFcShort( 0x1 ), /* Corr flags: early, */
/* 742 */ 0x6, /* FC_SHORT */
                                0x5b,          /* FC_END */
/* 744 */
                                0x1a,          /* FC_BOGUS_STRUCT */
                                0x3,          /* 3 */
/* 746 */ NdrFcShort( 0x10 ), /* 16 */
/* 748 */ NdrFcShort( 0x0 ), /* 0 */
/* 750 */ NdrFcShort( 0x6 ), /* Offset= 6 (756) */
/* 752 */ 0x8, /* FC_LONG */
                                0x39,          /* FC_ALIGNM8 */
/* 754 */ 0x36, /* FC_POINTER */
                                0x5b,          /* FC_END */
/* 756 */
                                0x12, 0x0,          /* FC_UP */
/* 758 */ NdrFcShort( 0xffffffffe6 ), /* Offset= -26 (732) */
/* 760 */
                                0x1b,          /* FC_CARRAY */
                                0x3,          /* 3 */
/* 762 */ NdrFcShort( 0x4 ), /* 4 */
/* 764 */ 0x19, /* Corr desc: field pointer, FC_ULONG */
                                0x0,          /* */
/* 766 */ NdrFcShort( 0x0 ), /* 0 */
/* 768 */ NdrFcShort( 0x1 ), /* Corr flags: early, */
/* 770 */ 0x8, /* FC_LONG */
                                0x5b,          /* FC_END */
/* 772 */
                                0x1a,          /* FC_BOGUS_STRUCT */
                                0x3,          /* 3 */
/* 774 */ NdrFcShort( 0x10 ), /* 16 */

/* 776 */ NdrFcShort( 0x0 ), /* 0 */
/* 778 */ NdrFcShort( 0x6 ), /* Offset= 6 (784) */
/* 780 */ 0x8, /* FC_LONG */
                                0x39,          /* FC_ALIGNM8 */
/* 782 */ 0x36, /* FC_POINTER */
                                0x5b,          /* FC_END */
/* 784 */
                                0x12, 0x0,          /* FC_UP */
/* 786 */ NdrFcShort( 0xffffffffe6 ), /* Offset= -26 (760) */
/* 788 */
                                0x1b,          /* FC_CARRAY */
                                0x7,          /* 7 */
/* 790 */ NdrFcShort( 0x8 ), /* 8 */
/* 792 */ 0x19, /* Corr desc: field pointer, FC_ULONG */
                                0x0,          /* */
/* 794 */ NdrFcShort( 0x0 ), /* 0 */
/* 796 */ NdrFcShort( 0x1 ), /* Corr flags: early, */
/* 798 */ 0xb, /* FC_HYPER */
                                0x5b,          /* FC_END */
/* 800 */
                                0x1a,          /* FC_BOGUS_STRUCT */
                                0x3,          /* 3 */
/* 802 */ NdrFcShort( 0x10 ), /* 16 */
/* 804 */ NdrFcShort( 0x0 ), /* 0 */
/* 806 */ NdrFcShort( 0x6 ), /* Offset= 6 (812) */
/* 808 */ 0x8, /* FC_LONG */
                                0x39,          /* FC_ALIGNM8 */
/* 810 */ 0x36, /* FC_POINTER */
                                0x5b,          /* FC_END */
/* 812 */
                                0x12, 0x0,          /* FC_UP */
/* 814 */ NdrFcShort( 0xffffffffe6 ), /* Offset= -26 (788) */
/* 816 */
                                0x15,          /* FC_STRUCT */
                                0x3,          /* 3 */
/* 818 */ NdrFcShort( 0x8 ), /* 8 */
/* 820 */ 0x8, /* FC_LONG */
                                0x8,          /* FC_LONG */
/* 822 */ 0x5c, /* FC_PAD */
                                0x5b,          /* FC_END */
/* 824 */
                                0x1b,          /* FC_CARRAY */
                                0x3,          /* 3 */
/* 826 */ NdrFcShort( 0x8 ), /* 8 */
/* 828 */ 0x7, /* Corr desc: FC_USHORT */
                                0x0,          /* */
/* 830 */ NdrFcShort( 0xffc8 ), /* -56 */
/* 832 */ NdrFcShort( 0x1 ), /* Corr flags: early, */
/* 834 */ 0x4c, /* FC_EMBEDDED_COMPLEX */
                                0x0,          /* 0 */
/* 836 */ NdrFcShort( 0xffffffffec ), /* Offset= -20 (816) */
/* 838 */ 0x5c, /* FC_PAD */
                                0x5b,          /* FC_END */
/* 840 */
                                0x1a,          /* FC_BOGUS_STRUCT */
                                0x3,          /* 3 */
/* 842 */ NdrFcShort( 0x38 ), /* 56 */
/* 844 */ NdrFcShort( 0xffffffffec ), /* Offset= -20 (824) */
/* 846 */ NdrFcShort( 0x0 ), /* Offset= 0 (846) */
/* 848 */ 0x6, /* FC_SHORT */
                                0x6,          /* FC_SHORT */
/* 850 */ 0x38, /* FC_ALIGNM4 */
                                0x8,          /* FC_LONG */
```

Appendix A - Application Source Code

```
#define _tpcc_com_ps_CHECK_IID(n) IID_GENERIC_CHECK_IID( _tpcc_com_ps, pIID, n)

int __stdcall _tpcc_com_ps_IID_Lookup( const IID * pIID, int * pIndex )
{
    if(!_tpcc_com_ps_CHECK_IID(0))
    {
        *pIndex = 0;
        return 1;
    }

    return 0;
}

const ExtendedProxyFileInfo tpcc_com_ps_ProxyFileInfo =
{
    (PCInterfaceProxyVtblList *) & _tpcc_com_ps_ProxyVtblList,
    (PCInterfaceStubVtblList *) & _tpcc_com_ps_StubVtblList,
    (const PCInterfaceName * ) & _tpcc_com_ps_InterfaceNamesList,
    0, // no delegation
    & _tpcc_com_ps_IID_Lookup,
    1,
    2,
    0, /* table of [async_uuid] interfaces */
    0, /* Filler1 */
    0, /* Filler2 */
    0 /* Filler3 */
};

#endif /* defined(_M_IA64) || defined(_M_AXP64)*/
```

common/txnlog/include/rtetime.h

```
/* FILE: rtetime.h : header file
 * Copyright 1997 Microsoft Corp., All rights reserved.
 *
 * Authors: Charles Levine, Philip Durr
 *          Microsoft Corp.
 */

#define MAX_JULIAN_TIME 0x7FFFFFFFFFFFFFFF
#define JULIAN_TIME __int64
#define TC_TIME DWORD
extern "C"
{
    BOOL InitJulianTime(LPSYSTEMTIME lpInitTime);
    JULIAN_TIME GetJulianTime(void);
    DWORD MyTickCount(void);
    void GetJulianAndTC(JULIAN_TIME *pJulian, DWORD *pTC);
    JULIAN_TIME ConvertTo64BitTime(int iYear, int iMonth, int iDay, int iHour, int
    iMinute, int iSecond);
    JULIAN_TIME Get64BitTime(LPSYSTEMTIME lpInitTime);
    int JulianDay( int yr, int mm, int dd );
}
```

```
void JulianToTime(JULIAN_TIME julianTS, int* yr, int* mm, int* dd, int
*hh, int *mi, int *ss );
void JulianToCalendar( int day, int* yr, int* mm, int* dd );
}
```

common/txnlog/include/spinlock.h

```
/* FILE: SPINLOCK.H
 *
 * Copyright 1997 Microsoft Corp., All rights reserved.
 *
 * Authors: Mike Parkes, Charles Levine, Philip Durr
 *          Microsoft Corp.
 */

#ifndef _INC_Spinlock

const LONG LockClosed = 1;
const LONG LockOpen = 0;

/*****
 *
 * Spinlock and Semaphore locking.
 *
 * This class provides a very conservative locking scheme.
 * The assumption behind the code is that locks will be
 * held for a very short time. When a lock is taken a memory
 * location is exchanged. All other threads that want this
 * lock wait by spinning and sometimes sleeping on a semaphore
 * until it becomes free again. The only other choice is not
 * to wait at all and move on to do something else. This
 * module should normally be used in conjunction with cache
 * aligned memory in minimize cache line misses.
 *
 *****/

class Spinlock
{
    // Private data.
    HANDLE Semaphore;
    volatile LONG m_Spinlock;
    volatile LONG Waiting;

#ifdef _DEBUG
    // Counters for debugging builds.
    volatile LONG TotalLocks;
    volatile LONG TotalSleeps;
    volatile LONG TotalSpins;
    volatile LONG TotalWaits;
#endif

public:
    // Public functions.
    Spinlock( void );
};
```

Appendix A - Application Source Code

```
inline BOOL ClaimLock( BOOL Wait = TRUE );
inline void ReleaseLock( void );
~Spinlock( void );
// Disabled operations.
Spinlock( const Spinlock & Copy );
void operator=( const Spinlock & Copy );

private:
    // Private functions.
    inline BOOL ClaimSpinlock( volatile LONG *sl );
    void WaitForLock( void );
    void WakeAllSleepers( void );
};

/*****
 *
 * A guaranteed atomic exchange.
 *
 * An attempt is made to claim the Spinlock. This action is
 * guaranteed to be atomic.
 *
 *****/

inline BOOL Spinlock::ClaimSpinlock( volatile LONG *Spinlock )
{
    #ifdef _DEBUG
        InterlockedIncrement( (LPLONG) & TotalLocks );
    #endif
    return ( ((*Spinlock) == LockOpen) && (InterlockedExchange(
(LPLONG)Spinlock, LockClosed) == LockOpen) );
}

/*****
 *
 * Claim the Spinlock.
 *
 * Claim the lock if available else wait or exit.
 *
 *****/

inline BOOL Spinlock::ClaimLock( BOOL Wait )
{
    if ( ! ClaimSpinlock( (volatile LONG*) & m_Spinlock ) )
    {
        if ( Wait )
            WaitForLock();
        return Wait;
    }
    return TRUE;
}

/*****
 *
 * Release the Spinlock.
 *
 * Release the lock and if needed wakeup any sleepers.
 *
 *****/

inline void Spinlock::ReleaseLock( void )
{
    m_Spinlock = LockOpen;
}
```

```
        if ( Waiting > 0 )
            WakeAllSleepers();
    }

    #define _INC_Spinlock

#endif
```

common/txnlog/include/txnlog.h

```
/* FILE: TXNLOG.H Microsoft TPC-C Kit Ver. 4.10.000
 *
 * NOTE: this file is RTE specific and should not be
 * included in Full Disclosure Reports.
 *
 * Copyright Microsoft, 1999
 *
 * PURPOSE: Structure definitions for logging delivery txn completion stats.
 * Contact: Charles Levine (clevine@microsoft.com)
 */

typedef struct _TXN_NEWORDER
{
    BYTE OL_Count; //range 0 to 31
    BYTE OL_Remote_Count; //range 0 to 31
    WORD c_id;
    int o_id;
} TXN_NEWORDER;

typedef struct _TXN_PAYMENT
{
    BYTE CustByName;
    BYTE IsRemote;
} TXN_PAYMENT;

typedef struct _TXN_ORDERSTATUS
{
    BYTE CustByName;
} TXN_ORDERSTATUS;

typedef union _TXN_DETAILS
{
    TXN_NEWORDER NewOrder;
    TXN_PAYMENT Payment;
    TXN_ORDERSTATUS OrderStatus;
} TXN_DETAILS;

// Common header for all records in txn log. The TxnType field is
// a switch which identifies the particular variant.
#define TXN_REC_TYPE_CONTROL 1 //
```

Appendix A - Application Source Code

```
#define TXN_REC_TYPE_TPCC                2        // replaces
TRANSACTION_TYPE_TPCC
#define TXN_REC_TYPE_TPCC_DELIV_DEF     3

typedef struct _TXN_RECORD_HEADER
{
    JULIAN_TIME    TxnStartT0;        // start of txn
    BYTE          TxnType;           // one of TXN_REC_TYPE_*
    BYTE          TxnSubType;        // depends on
} TXN_RECORD_HEADER, *PTXN_RECORD_HEADER;

typedef struct _TXN_RECORD_CONTROL
{
    // common header: must exactly match TXN_RECORD_HEADER
    JULIAN_TIME    TxnStartT0;        // start of txn
    BYTE          TxnType;           // = TXN_REC_TYPE_CONTROL
    BYTE          TxnSubType;        // depends on
} TXN_RECORD_CONTROL, *PTXN_RECORD_CONTROL;

// end of common header

DWORD          Len;                // number of bytes

// TPC-C Txn Record Layout:
//
// 'TxnStartT0' is a Julian timestamp corresponding to the moment the
// txn is sent to the SUT, i.e., beginning of response time. Deltas
// are in milliseconds. Note that if RTDelay > 0, then the txn was
// delayed by this amount. The delay occurs at the beginning of the
// response time. So if RTDelay > 0, then the txn was actually sent
// at TxnStartT0 + RTDelay.
//
// Graphically:
//
// time -->
//
// |--- Menu ---|--- Keying ---|--- Response ---|--- Think ---|
// <- DeltaT1 -> <- DeltaT2 -> <- DeltaT4 -> <- DeltaT3 ->
//
//           ^
//           ^ TxnStartT0
//
// RTDelay is the amount of response time delay included in DeltaT4.
// RTDelay is recorded per txn because this value can be changed on
// the fly, and so may vary from txn to txn.
//
// TxnStatus is the txn completion code. It is used to indicate errors.
// For example, in the New Order txn, 1% of txns abort. TxnStatus will
// reflect this.

typedef struct _TXN_RECORD_TPCC
{
    // common header: must exactly match TXN_RECORD_HEADER
    JULIAN_TIME    TxnStartT0;        // start of txn
    BYTE          TxnType;           // = TXN_REC_TYPE_TPCC
    BYTE          TxnSubType;        // depends on
} TXN_RECORD_TPCC, *PTXN_RECORD_TPCC;

int          DeltaT1;                // menu time (ms)
```

```
int          DeltaT2;                // keying time (ms)
int          DeltaT3;                // think time (ms)
int          DeltaT4;                // response time (ms)
int          RTDelay;                // response time delay (ms)
int          TxnError;                // error code providing more
detail for TxnStatus
WORD        w_id;                    // warehouse ID
BYTE        d_id;                    // assigned district ID for
this thread
BYTE        d_id_ThisTxn;            // district ID chosen for this
particular
BYTE        TxnStatus;                // completion status for txn
to indicate errors
BYTE        reserved;                // for word alignment
TXN_DETAILS    TxnDetails;            //
} TXN_RECORD_TPCC, *PTXN_RECORD_TPCC;

// TPC-C Deferred Delivery Txn Record Layout:
//
// Incorporating delivery transaction information into the above
// structure would increase the size of TXN_DETAILS from 8 to 42 bytes.
// Hence, we store delivery transaction details in a separate structure.
//
typedef struct _TXN_RECORD_TPCC_DELIV_DEF
{
    // common header: must exactly match TXN_RECORD_HEADER
    JULIAN_TIME    TxnStartT0;        // start of txn
    BYTE          TxnType;           // =
TXN_REC_TYPE_TPCC_DELIV_DEF
    BYTE          TxnSubType;        // = 0
    // end of common header

    int          DeltaT4;                // response time (ms)
    int          DeltaTxnExec;        // execution time (ms)
    WORD        w_id;                    // warehouse ID
    BYTE        TxnStatus;                // completion status for txn
to indicate errors
    BYTE        reserved;                // for word alignment
    short       o_carrier_id;            // carrier id
    long        o_id[10];                // returned delivery transaction ids
} TXN_RECORD_TPCC_DELIV_DEF, *PTXN_RECORD_TPCC_DELIV_DEF;

#define TXN_LOG_VERSION                1
#define TXN_DATA_START                4096    // offset in log file where
log records start
#define TXN_LOG_EYE_CATCHER "BC"        // signature bytes at the start of log
file

//
// The transaction log has a header as the first 4K block.
//
typedef struct _TXN_LOG_HEADER
{
    char          EyeCatcher[2];        // signature bytes;
should always be "BC"
    int          LogVersion;
// set to TXN_LOG_VERSION
    JULIAN_TIME    BeginTxnTS;        //
timestamp of first (lowest) txn start
```

Appendix A - Application Source Code

```

        JULIAN_TIME          EndTxnTS;          // timestamp of
last (highest) txn completion time
        int
        // number of records in log file
        BOOL                iRecCount;
        // file size in bytes
        int                bLogSorted;
        // file size in bytes
        int                iFileSize;

        // the record map provides a fast way to get close to a particular
timestamp in a sorted log file.
        // struct
        // {
        //     JULIAN_TIME          TS;
        //     timestamp of record
        //     int                iPos;
        //     // byte position in file
        //     }
        // RecMap[RecMapSize];
#define RecMapSize          200
    } TXN_LOG_HEADER, *PTXN_LOG_HEADER;

#define READ_BUFFER_SIZE    64*1024
#define WRITE_BUFFER_SIZE   8*1024

#define NUM_READ_BUFFERS    1
#define NUM_WRITE_BUFFERS   2
#define MAX_NUM_BUFFERS     2

// flags passed in to the constructor
#define TXN_LOG_WRITE        0x01
#define TXN_LOG_READ        0x02
#define TXN_LOG_SORTED     0x04

#define TXN_LOG_OS_ERROR    1
#define TXN_LOG_NOT_SORTED 2

#define SKIP_CTRL_RECS     1

class CTxnLog
{
private:
    DWORD                iBufferSize;          //buffer
allocated size
    DWORD                iBytesFreeInBuffer;   //total bytes
available for use in buffer
    int                iNumBuffers;
        //buffers in use
    int                iActiveBuffer;
        //indicates which buffer is active: 0 or 1
    int                iIoBuffer;
        //buffer for any pending IO operation
    int                iFilePointer;
        //position in file.
    int                iNextRec;
        //when reading, ordinal value of next record

        // A "save point" is remembered each time GetNextRecord is called
with a start time specified.
        // The next time it is called, if start time is after the save point,
we start scanning from the

```

```

        // save point. This is particularly useful in FindBestInterval,
where the log is scanned repeatedly.
        JULIAN_TIME          SavePtTime;
        int                iSavePtFilePointer;
        int                iSavePtNextRec;

        JULIAN_TIME          lastTS;
        //when writing sorted output, used to verify records are sorted
        BOOL                bWrite;
        //writing log file

        BOOL                bLogSorted;
        // is log file sorted? applies to both input and output
        JULIAN_TIME          BeginTxnTS;
        // timestamp of first (lowest) txn start
        JULIAN_TIME          EndTxnTS;
timestamp of last (highest) txn completion time
        int                iRecCount;
        // number of records in log file

        BYTE                *pCurrent;
        //ptr to current buffer
        BYTE                *pBuffer[MAX_NUM_BUFFERS];

        PTXN_RECORD_HEADER *TxnArray;          //transaction
record pointer array for sort

        DWORD                dwError;
        HANDLE                hTxnFile;          //handle
to log file
        HANDLE                hMapFile;          //map
file used when sorting the log
        HANDLE                hIoComplete;      //event
to signify that there are no pending IOs
        HANDLE                hLogFileIo;
        //event to signal the IO thread to write the inactive buffer

        Spinlock Spin;          //spin
lock to protect the txn log file buffers

        int Write(BYTE *ptr, DWORD Size);
        static void LogFileIO(CTxnLog *);

public:
    CTxnLog::CTxnLog(LPCTSTR szFileName, DWORD dwOpts);
    ~CTxnLog(void);

    int WriteToLog(PTXN_RECORD_TPCC pTxnRcprd);
    int WriteToLog(PTXN_RECORD_TPCC_DELIV_DEF pTxnRcprd);
    int WriteToLog(PTXN_RECORD_CONTROL pCtrlRec);
    int WriteToLog(PTXN_RECORD_HEADER pCtrlRec);

    int WriteCtrlRecToLog(BYTE SubType, LPCTSTR lpStr, DWORD dwLen);

    void CloseTransactionLogFile(void);

    PTXN_RECORD_HEADER GetNextRecord(BOOL bSkipCtrlRecs = FALSE);
    PTXN_RECORD_HEADER GetNextRecord(JULIAN_TIME SeekTimeT0, BOOL
bSkipCtrlRecs = FALSE);

    int Sort(void);
    PTXN_RECORD_HEADER GetSortedRecord(int index);

```

Appendix A - Application Source Code

```
inline BOOL IsSorted(void) { return bLogSorted; };
inline JULIAN_TIME BeginTS(void) { return BeginTxnTS; };
inline JULIAN_TIME EndTS(void) { return EndTxnTS; };
inline int RecordCount(void) { return iRecCount; };
};

class CTXNLOG_ERR : public CBaseErr
{
public:
enum CTPCC_DBLIB_ERRS
{
ERR_BAD_FILE_FORMAT = 1, // "File format is invalid."
ERR_UNKNOWN_LOG_VERSION, // "Log file version is
unknown."
ERR_BROKEN_LOG_FILE, // "Log file is
broken."
ERR_LOG_NOT_SORTED, // "Log file is not
sorted"
ERR_INVALID_TIME_SEQ, // "Internal Error:
Record Time Sequence invalid."
};

CTXNLOG_ERR( int iErr ) { m_errno = iErr; };

int m_errno;

int ErrorType() {return ERR_TYPE_TXNLOG;};
int ErrorNum() {return m_errno;};

// TODO: need to complete...
char *ErrorText() {return ""};
};
```

Appendix B - Database Design

Appendix B - Database Design

Build Scripts

setup.cmd

```
ECHO OFF

@ECHO *****
@ECHO *
@ECHO * Microsoft TPC-C Benchmark Kit Ver. 4.01 *
@ECHO *
@ECHO *****

if '%1'==' ' goto usage
if '%2'==' ' goto usage
if '%3'==' ' goto usage
if '%4'==' ' goto usage
if not '%5'==' ' if not '%5' == 'scaled' goto usage

::Cleanup any old .err files
@if exist logs\*.err del logs\*.err
>nul

if '%3'=='full' goto start
if '%3'=='bulddb' goto bulddb
if '%3'=='objects' goto objects
if '%3'=='bulkload' goto bulkload
if '%3'=='objectsfull' goto objects
if '%3'=='bulkloadfull' goto bulkload
if '%3'=='backup' goto backup
goto usage

:start
:: Cleanup the logs directory...
@if exist logs\version.log del logs\version.log >nul
@if exist logs\db.log del logs\db.log >nul
@if exist logs\objects.log del logs\objects.log >nul
@if exist logs\objects.log del logs\objects.log >nul
@if exist logs\bulkload.log del logs\bulkload.log >nul
@if exist logs\backup.log del logs\backup.log >nul

isql -Usa -P -S%1 -Q"select @@version" >
logs\version.log
isql -Usa -P -S%1 -Q"select getdate()" >>
logs\version.log

:bulddb
@if exist logs\db.log del logs\db.log >nul
@ECHO Building database files and database...
isql -Usa -P -S%1 -e < scripts\%2.war\%4\createdb.sql >
logs\db.log
@ECHO Database build complete.
if '%3'=='full' goto objects
```

```
goto end

:objects
@if exist logs\objects.log del logs\objects.log >nul
@ECHO Creating database objects...
isql -Usa -P -S%1 -e < scripts\ddl\%4\tables.sql > logs\objects.log
isql -Usa -P -S%1 -e < scripts\dml\%4\neword.sql >> logs\objects.log
isql -Usa -P -S%1 -e < scripts\dml\%4\payment.sql >> logs\objects.log
isql -Usa -P -S%1 -e < scripts\dml\%4\ordstat.sql >> logs\objects.log
isql -Usa -P -S%1 -e < scripts\dml\%4\delivery.sql >>
logs\objects.log
isql -Usa -P -S%1 -e < scripts\dml\%4\stocklev.sql >>
logs\objects.log
@ECHO Database object creation complete.
if '%3'=='full' goto bulkload
if '%3'=='objectsfull' goto bulkload
goto end

:bulkload
@if exist logs\bulkload.log del logs\bulkload.log >nul
@ECHO Beginning data load and index creation...
isql -Usa -P -S%1 -e < scripts\utility\%4\dbopt1.sql >>
logs\objects.log
if '%4'=='mssql70' goto odbc
if '%4'=='mssql65' goto dlib
goto usage
:dlib
if '%5'==' ' loader\%4\bin\tpccldr -S%1 -W%2 -flogs\bulkload.log -dscrip\ddl\%4 -c0
if '%5'=='normal' loader\%4\bin\tpccldr -S%1 -W%2 -flogs\bulkload.log -dscrip\ddl\%4 -c0
if '%5'=='scaled' loader\%4\bin\tpccldr -S%1 -W%2 -flogs\bulkload.log -dscrip\ddl\%4 -c1
goto bulkloaddone
:odbc
if '%5'==' ' loader\%4\bin\tpccldr -S%1 -W%2 -flogs\bulkload.log -dscrip\ddl\%4 -c0
if '%5'=='normal' loader\%4\bin\tpccldr -S%1 -W%2 -flogs\bulkload.log -dscrip\ddl\%4 -c0
if '%5'=='scaled' loader\%4\bin\tpccldr -S%1 -W%2 -flogs\bulkload.log -dscrip\ddl\%4 -c1
goto bulkloaddone
:bulkloaddone
isql -Usa -P -S%1 -e < scripts\utility\%4\dbopt2.sql >>
logs\bulkload.log
@ECHO Data load and index creation complete.
if '%3'=='full' goto backup
if '%3'=='objectsfull' goto backup
if '%3'=='bulkloadfull' goto backup
goto end

:backup
@if exist logs\backup.log del logs\backup.log >nul
@ECHO Backing up database...
isql -Usa -P -S%1 -e < scripts\%2.war\%4\backup.sql >
logs\backup.log
@ECHO Database backup complete.
if '%3'=='full' goto verifyload
if '%3'=='objectsfull' goto verifyload
if '%3'=='bulkloadfull' goto verifyload
goto complete

:verifyload
@if exist logs\verifyload.log del logs\verifyload.log >nul
@Echo Verifying TPC-C database load...
```

Appendix B - Database Design

```
isql -Usa -P -S%1 < scripts\utility\%4\verifytpccload.sql >
logs\verifyload.log
@ECHO Check logs\verifyload.log to verify database load.

:complete
@ECHO *****
@ECHO *
@ECHO * Full TPC-C build complete. Check logs directory for setup errors. *
@ECHO *
@ECHO * *****
goto end

:usage
@ECHO *****
@ECHO *
@ECHO * The TPC-C setup command file requires the following parameters: *
@ECHO *
@ECHO * setup SERVER NUMWAR BLDOPT VERSION DBTYPE *
@ECHO *
@ECHO * SERVER = machine name of server (use "" for local server) *
@ECHO * NUMWAR = number of warehouses *
@ECHO * BLDOPT = full, builddb, objects, objectsfull, bulkload, *
@ECHO * bulkloadfull, or backup *
@ECHO * VERSION = mssql65 or mssql70 *
@ECHO * DBTYPE = normal or scaled *
@ECHO *
@ECHO * Note #1: the BLDOPT and VERSION parameters are case sensitive. *
@ECHO *
@ECHO * Note #2: the DBTYPE is optional. If no DBTYPE is specified, SETUP *
@ECHO * will default to NORMAL. *
@ECHO *
@ECHO * Example: *
@ECHO *
@ECHO * The following command would be used to build a complete 200 *
@ECHO * warehouse database on SQL Server 7.0 running on server \\myserver. *
@ECHO *
@ECHO * SETUP myserver 200 full mssql70 *
@ECHO *
@ECHO * Note, this command file does a backup of the database by default *
@ECHO * after the database build process is complete. If you do not wish *
@ECHO * to make a backup (strongly discouraged), you must edit this file *
@ECHO * and comment that section out. Also, if you need to run the dbcheck *
@ECHO * and the dbtables scripts on the fresh database load for an audit, *
@ECHO * you must either run them manually or edit this file to include them. *
@ECHO *
@ECHO * *****

:end
echo on

createdb.sql
-- File: CREATEDB.SQL
-- Microsoft TPC-C Benchmark Kit Ver. 4.21
-- Copyright Microsoft, 1999, 2000
-- Purpose: Creates tpcc database and backup files

use master
```

```
go
-- Create temporary table for timing
if exists ( select name from sysobjects where name = 'tpcc_timer' )
drop table tpcc_timer
go
create table tpcc_timer
(
start_date char(30),
end_date char(30)
)
insert into tpcc_timer values (0,0)
go
-- Store starting time
update tpcc_timer
set start_date = (select convert(char(30), getdate(),9))
go
-- create main database files
CREATE DATABASE tpcc
ON PRIMARY
(
NAME = MSSQL70_tpcc_root,
FILENAME = "C:\MSSQL70_tpcc_root.mdf",
SIZE = 8MB,
FILEGROWTH = 0),
FILEGROUP MSSQL70_misc_fg
(
NAME = MSSQL70_misc1,
FILENAME = "F:",
SIZE = 85632MB,
FILEGROWTH = 0),
(
NAME = MSSQL70_misc2,
FILENAME = "H:",
SIZE = 85632MB,
FILEGROWTH = 0),
(
NAME = MSSQL70_misc3,
FILENAME = "J:",
SIZE = 85632MB,
FILEGROWTH = 0),
(
NAME = MSSQL70_misc4,
FILENAME = "L:",
SIZE = 85632MB,
FILEGROWTH = 0),
(
NAME = MSSQL70_misc5,
FILENAME = "N:",
SIZE = 85632MB,
FILEGROWTH = 0),
FILEGROUP MSSQL70_cs_fg
(
NAME = MSSQL70_cs1,
FILENAME = "E:",
SIZE = 154656MB,
FILEGROWTH = 0),
(
NAME = MSSQL70_cs2,
FILENAME = "G:",
SIZE = 154656MB,
FILEGROWTH = 0),
(
NAME = MSSQL70_cs3,
```

Appendix B - Database Design

```
        FILENAME = "I:",
        SIZE      = 154656MB,
        FILEGROWTH = 0),
(
    NAME      = MSSQL70_cs4,
    FILENAME = "K:",
    SIZE      = 154656MB,
    FILEGROWTH = 0),
(
    NAME      = MSSQL70_cs5,
    FILENAME = "M:",
    SIZE      = 154656MB,
    FILEGROWTH = 0)
LOG ON
(
    NAME      =MSSQL70_tpccv3_log,
    FILENAME = "S:",
    SIZE      =208200MB,
    FILEGROWTH =0)
go

-- Store ending time
update tpcc_timer
set end_date = (select convert(char(30), getdate(),9))
go

select "Elapsed time (in seconds): ", datediff(second,(select start_date from
tpcc_timer),(select end_date from tpcc_timer))

--      remove temporary table

if exists ( select name from sysobjects where name = 'tpcc_timer' )
drop table tpcc_timer
go
```

tables.sql

```
-- File: TABLES.SQL
-- Microsoft TPC-C Benchmark Kit Ver. 4.00
-- Copyright Microsoft, 1996
-- Purpose: Creates TPC-C tables

use tpcc
go

if exists ( select name from sysobjects where name = 'warehouse' )
drop table warehouse
go
create table warehouse
(
    w_id          smallint,
    w_name        char(10),
    w_street_1    char(20),
    w_street_2    char(20),
    w_city        char(20),
    w_state       char(2),
    w_zip         char(9),
    w_tax         numeric(4,4),
    w_ytd         numeric(12,2)
) on MSSQL70_misc_fg
go
```

```
if exists ( select name from sysobjects where name = 'district' )
drop table district
go
create table district
(
    d_id          tinyint,
    d_w_id        smallint,
    d_name        char(10),
    d_street_1    char(20),
    d_street_2    char(20),
    d_city        char(20),
    d_state       char(2),
    d_zip         char(9),
    d_tax         numeric(4,4),
    d_ytd         numeric(12,2),
    d_next_o_id   int
) on MSSQL70_misc_fg
go

if exists ( select name from sysobjects where name = 'customer' )
drop table customer
go
create table customer
(
    c_id          int,
    c_d_id        tinyint,
    c_w_id        smallint,
    c_first       char(16),
    c_middle      char(2),
    c_last        char(16),
    c_street_1    char(20),
    c_street_2    char(20),
    c_city        char(20),
    c_state       char(2),
    c_zip         char(9),
    c_phone       char(16),
    c_since       datetime,
    c_credit      char(2),
    c_credit_lim  numeric(12,2),
    c_discount    numeric(4,4),
    c_balance     numeric(12,2),
    c_ytd_payment numeric(12,2),
    c_payment_cnt smallint,
    c_delivery_cnt smallint,
    c_data        char(500)
) on MSSQL70_cs_fg
go

if exists ( select name from sysobjects where name = 'history' )
drop table history
go
create table history
(
    h_c_id        int,
    h_c_d_id      tinyint,
    h_c_w_id      smallint,
    h_d_id        tinyint,
    h_w_id        smallint,
    h_date        datetime,
    h_amount      numeric(6,2),
    h_data        char(24)
) on MSSQL70_misc_fg
go
```

Appendix B - Database Design

```
if exists ( select name from sysobjects where name = 'new_order' )
    drop table new_order
go
create table new_order
(
    no_o_id          int,
    no_d_id          tinyint,
    no_w_id          smallint
) on MSSQL70_misc_fg
go

if exists ( select name from sysobjects where name = 'orders' )
    drop table orders
go
create table orders
(
    o_id            int,
    o_d_id          tinyint,
    o_w_id          smallint,
    o_c_id          int,
    o_entry_d       datetime,
    o_carrier_id    tinyint,
    o_ol_cnt        tinyint,
    o_all_local     tinyint
) on MSSQL70_misc_fg
go

if exists ( select name from sysobjects where name = 'order_line' )
    drop table order_line
go
create table order_line
(
    ol_o_id          int,
    ol_d_id          tinyint,
    ol_w_id          smallint,
    ol_number        tinyint,
    ol_i_id          int,
    ol_supply_w_id   smallint,
    ol_delivery_d    datetime,
    ol_quantity      smallint,
    ol_amount        numeric(6,2),
    ol_dist_info     char(24)
) on MSSQL70_misc_fg
go

if exists ( select name from sysobjects where name = 'item' )
    drop table item
go
create table item
(
    i_id            int,
    i_im_id         int,
    i_name          char(24),
    i_price         numeric(5,2),
    i_data          char(50)
) on MSSQL70_misc_fg
go

if exists ( select name from sysobjects where name = 'stock' )
    drop table stock
go
create table stock
```

```
(
    s_i_id          int,
    s_w_id          smallint,
    s_quantity      smallint,
    s_dist_01       char(24),
    s_dist_02       char(24),
    s_dist_03       char(24),
    s_dist_04       char(24),
    s_dist_05       char(24),
    s_dist_06       char(24),
    s_dist_07       char(24),
    s_dist_08       char(24),
    s_dist_09       char(24),
    s_dist_10       char(24),
    s_ytd           int,
    s_order_cnt     smallint,
    s_remote_cnt    smallint,
    s_data          char(50)
) on MSSQL70_cs_fg
go
```

idxcuscl.sql

```
-- File:      IDXCUSCL.SQL
--           Microsoft TPC-C Benchmark Kit Ver. 4.00
--           Copyright Microsoft, 1996
-- Purpose:   Creates clustered index on customer table
```

```
use tpcc
go
```

```
declare @startdate datetime
declare @enddate datetime
select @startdate = getdate()
select "Start date:", convert(varchar(30),@startdate,9)
```

```
if exists ( select name from sysindexes where name = 'customer_c1' )
    drop index customer.customer_c1
```

```
create unique clustered index customer_c1 on customer(c_w_id, c_d_id, c_id)
on MSSQL70_cs_fg
```

```
select @enddate = getdate()
select "End date: ", convert(varchar(30),@enddate,9)
select "Elapsed time (in seconds): ", datediff(second, @startdate, @enddate)
```

```
go
```

idxcusnc.sql

```
-- File:      IDXCUSNC.SQL
--           Microsoft TPC-C Benchmark Kit Ver. 4.00
```

Appendix B - Database Design

```
-- Copyright Microsoft, 1996
-- Purpose: Creates non-clustered index on customer table

use tpcc
go

declare @startdate datetime
declare @enddate datetime
select @startdate = getdate()
select "Start date:", convert(varchar(30),@startdate,9)

if exists ( select name from sysindexes where name = 'customer_nc1' )
    drop index customer.customer_nc1

create unique nonclustered index customer_nc1 on customer(c_w_id, c_d_id, c_last,
c_first, c_id)
    on MSSQL70_cs_fg

select @enddate = getdate()
select "End date: ", convert(varchar(30),@enddate,9)
select "Elapsed time (in seconds): ", datediff(second, @startdate, @enddate)

go
```

idxdiscl.sql

```
-- File:      IDXDISCL.SQL
--           Microsoft TPC-C Benchmark Kit Ver. 4.00
--           Copyright Microsoft, 1996
-- Purpose:   Creates clustered index on district table

use tpcc
go

declare @startdate datetime
declare @enddate datetime
select @startdate = getdate()
select "Start date:", convert(varchar(30),@startdate,9)

if exists ( select name from sysindexes where name = 'district_c1' )
    drop index district.district_c1

create unique clustered index district_c1 on district(d_w_id, d_id)
    with fillfactor=100 on MSSQL70_misc_fg

select @enddate = getdate()
select "End date: ", convert(varchar(30),@enddate,9)
select "Elapsed time (in seconds): ", datediff(second, @startdate, @enddate)

go
```

idxitmcl.sql

```
-- File:      IDXITMCL.SQL
--           Microsoft TPC-C Benchmark Kit Ver. 4.00
--           Copyright Microsoft, 1996
-- Purpose:   Creates clustered index on item table

use tpcc
go

declare @startdate datetime
declare @enddate datetime
select @startdate = getdate()
select "Start date:", convert(varchar(30),@startdate,9)

if exists ( select name from sysindexes where name = 'item_c1' )
    drop index item.item_c1

create unique clustered index item_c1 on item(i_id)
    on MSSQL70_misc_fg

select @enddate = getdate()
select "End date: ", convert(varchar(30),@enddate,9)
select "Elapsed time (in seconds): ", datediff(second, @startdate, @enddate)

go
```

idxnodcl.sql

```
-- File:      IDXNODCL.SQL
--           Microsoft TPC-C Benchmark Kit Ver. 4.00
--           Copyright Microsoft, 1996
-- Purpose:   Creates clustered index on new_order table

use tpcc
go

declare @startdate datetime
declare @enddate datetime
select @startdate = getdate()
select "Start date:", convert(varchar(30),@startdate,9)

if exists ( select name from sysindexes where name = 'new_order_c1' )
    drop index new_order.new_order_c1

create unique clustered index new_order_c1 on new_order(no_w_id, no_d_id, no_o_id)
    on MSSQL70_misc_fg

select @enddate = getdate()
select "End date: ", convert(varchar(30),@enddate,9)
select "Elapsed time (in seconds): ", datediff(second, @startdate, @enddate)

go
```

Appendix B - Database Design

idxodcl.sql

```
-- File:      IDXNODCL.SQL
--           Microsoft TPC-C Benchmark Kit Ver. 4.00
--           Copyright Microsoft, 1996
-- Purpose:   Creates clustered index on new_order table

use tpcc
go

declare @startdate datetime
declare @enddate datetime
select @startdate = getdate()
select "Start date:", convert(varchar(30),@startdate,9)

if exists ( select name from sysindexes where name = 'new_order_c1' )
    drop index new_order.new_order_c1

create unique clustered index new_order_c1 on new_order(no_w_id, no_d_id, no_o_id)
on MSSQL70_misc_fg

select @enddate = getdate()
select "End date: ", convert(varchar(30),@enddate,9)
select "Elapsed time (in seconds): ", datediff(second, @startdate, @enddate)

go
```

idxordcl.sql

```
-- File:      IDXORDCL.SQL
--           Microsoft TPC-C Benchmark Kit Ver. 4.00
--           Copyright Microsoft, 1996
-- Purpose:   Creates clustered index on orders table

use tpcc
go

declare @startdate datetime
declare @enddate datetime
select @startdate = getdate()
select "Start date:", convert(varchar(30),@startdate,9)

if exists ( select name from sysindexes where name = 'orders_c1' )
    drop index orders.orders_c1

create unique clustered index orders_c1 on orders(o_w_id, o_d_id, o_id)
on MSSQL70_misc_fg

select @enddate = getdate()
select "End date: ", convert(varchar(30),@enddate,9)
select "Elapsed time (in seconds): ", datediff(second, @startdate, @enddate)

go
```

idxstkcl.sql

```
-- File:      IDXSTKCL.SQL
--           Microsoft TPC-C Benchmark Kit Ver. 4.00
--           Copyright Microsoft, 1996
-- Purpose:   Creates clustered index on stock table

use tpcc
go

declare @startdate datetime
declare @enddate datetime
select @startdate = getdate()
select "Start date:", convert(varchar(30),@startdate,9)

if exists ( select name from sysindexes where name = 'stock_c1' )
    drop index stock.stock_c1

create unique clustered index stock_c1 on stock(s_i_id, s_w_id)
on MSSQL70_cs_fg

select @enddate = getdate()
select "End date: ", convert(varchar(30),@enddate,9)
select "Elapsed time (in seconds): ", datediff(second, @startdate, @enddate)

go
```

idxwarcl.sql

```
-- File:      IDXWARCL.SQL
--           Microsoft TPC-C Benchmark Kit Ver. 4.00
--           Copyright Microsoft, 1996
-- Purpose:   Creates clustered index on warehouse table

use tpcc
go

declare @startdate datetime
declare @enddate datetime
select @startdate = getdate()
select "Start date:", convert(varchar(30),@startdate,9)

if exists ( select name from sysindexes where name = 'warehouse_c1' )
    drop index warehouse.warehouse_c1

create unique clustered index warehouse_c1 on warehouse(w_id)
with fillfactor=100 on MSSQL70_misc_fg

select @enddate = getdate()
select "End date: ", convert(varchar(30),@enddate,9)
select "Elapsed time (in seconds): ", datediff(second, @startdate, @enddate)
```

Appendix B - Database Design

```
go
```

dbopt1.sql

```
-- File:      DBOPT1.SQL
--           Microsoft TPC-C Benchmark Kit Ver. 4.00
--           Copyright Microsoft, 1996
-- Purpose:   Sets database options for data load
```

```
use master
go

exec sp_dboption tpcc,'select into/bulkcopy',true
exec sp_dboption tpcc,'trunc. log on chkpt.',true
go

use tpcc
go

checkpoint
go
```

dbopt2.sql

```
-- File:      DBOPT2.SQL
--           Microsoft TPC-C Benchmark Kit Ver. 4.00
--           Copyright Microsoft, 1996
-- Purpose:   Resets database options after data load
```

```
use master
go

sp_dboption tpcc,'select ',false
go

sp_dboption tpcc,'trunc. ',false
go

use tpcc
go

checkpoint
go

sp_configure allow,1
go

reconfigure with override
go
```

```
/*
/* Set option values for user-defined indexes */
/*
*/

sp_indexoption 'customer','AllowPageLocks',FALSE
go
sp_indexoption 'district','AllowPageLocks',FALSE
go
sp_indexoption 'warehouse','AllowPageLocks',FALSE
go
sp_indexoption 'stock','AllowPageLocks',FALSE
go
sp_indexoption 'order_line','AllowPageLocks',FALSE
go
sp_indexoption 'orders','AllowPageLocks',FALSE
go
sp_indexoption 'new_order','AllowRowLocks',FALSE
go
sp_indexoption 'item','AllowRowLocks',FALSE
go
sp_indexoption 'item','AllowPageLocks',FALSE
go

Print ' '
Print '*****'
Print 'Pre-specified Locking Hierarchy:'
Print '  Lockflag = 0 ==> No pre-pecified hierarchy'
Print '  Lockflag = 1 ==> Lock at Page-level then Table-level'
Print '  Lockflag = 2 ==> Lock at Row-level then Table-level'
Print '  Lockflag = 3 ==> Lock at Table-level'
Print ' '

select name,lockflags
from sysindexes
where object_id("warehouse")=id or
      object_id("district")=id or
      object_id("customer")=id or
      object_id("stock")=id or
      object_id("orders")=id or
      object_id("order_line")=id or
      object_id("history")=id or
      object_id("new_order")=id or
      object_id("item")=id

order by lockflags asc
go

sp_configure allow,0
go

reconfigure with override
go

exec sp_dboption tpcc, 'auto update statistics', FALSE
exec sp_dboption tpcc, 'auto create statistics', FALSE
go

exec sp_tableoption "district","pintable",true
exec sp_tableoption "warehouse","pintable",true
exec sp_tableoption "new_order","pintable",true
exec sp_tableoption "item","pintable",true
go
```

Appendix B - Database Design

dbopt3.sql

```
use tpcc
go
sp_indexoption 'orders','AllowPagelocks',TRUE
go
sp_indexoption 'orders','AllowRowlocks',FALSE
go
sp_indexoption 'order_line','AllowPagelocks',TRUE
go
sp_indexoption 'order_line','AllowRowlocks',FALSE
go
```

backup.sql

```
-- File:      BACKUP.SQL
--           Microsoft TPC-C Benchmark Kit Ver. 4.21
--           Copyright Microsoft, 1999, 2000
-- Purpose:   Creates backup of tpcc database

declare @startdate datetime
declare @enddate datetime
select @startdate = getdate()
select "Start date:", convert(varchar(30),@startdate,9)

dump database tpcc to tpccback1,tpccback2,tpccback3,tpccback4,tpccback5 with init, stats
= 5

select @enddate = getdate()
select "End date: ", convert(varchar(30),@enddate,9)
select "Elapsed time (in seconds): ", datediff(second, @startdate, @enddate)

go
```

restore.sql

```
-- File:      RESTORE.SQL
--           Microsoft TPC-C Benchmark Kit Ver. 4.21
--           Copyright Microsoft, 1999, 2000
-- Purpose:   Loads database backup from backup files

declare @startdate datetime
declare @enddate datetime
select @startdate = getdate()
select "Start date:", convert(varchar(30),@startdate,9)

load database tpcc from tpccback1,tpccback2,tpccback3,tpccback4,tpccback5 with stats = 5
```

```
select @enddate = getdate()
select "End date: ", convert(varchar(30),@enddate,9)
select "Elapsed time (in seconds): ", datediff(second, @startdate, @enddate)

go
```

Appendix B - Database Design

Stored Procedures

neword.sql

```
-- File:      NEWORD.SQL
--           Microsoft TPC-C Benchmark Kit Ver. 4.01
--           Copyright Microsoft, 1996
-- Purpose:   Creates new order transaction stored procedure
--
-- Modified 9/21/98 - Jamie Reding - Microsoft Corporation
--           Reordered @rowcount check so that invalid supply warehouse id,
--           as well as invalid item id, is detected and causes explicit
--           transaction rollback.
--
use tpcc
go

if exists ( select name from sysobjects where name = "tpcc_neworder" )
  drop procedure tpcc_neworder
go

create proc tpcc_neworder

    @w_id          smallint,
    @d_id          tinyint,
    @c_id          int,
    @o_ol_cnt      tinyint,
    @o_all_local   tinyint,
    @i_id1 int = 0, @s_w_id1 smallint = 0,
    @i_id2 int = 0, @s_w_id2 smallint = 0,
    @i_id3 int = 0, @s_w_id3 smallint = 0,
    @i_id4 int = 0, @s_w_id4 smallint = 0,
    @i_id5 int = 0, @s_w_id5 smallint = 0,
    @i_id6 int = 0, @s_w_id6 smallint = 0,
    @i_id7 int = 0, @s_w_id7 smallint = 0,
    @i_id8 int = 0, @s_w_id8 smallint = 0,
    @i_id9 int = 0, @s_w_id9 smallint = 0,
    @i_id10 int = 0, @s_w_id10 smallint =
    @i_id11 int = 0, @s_w_id11 smallint =
    @i_id12 int = 0, @s_w_id12 smallint =
    @i_id13 int = 0, @s_w_id13 smallint =

    @ol_qty1 smallint = 0,
    @ol_qty2 smallint = 0,
    @ol_qty3 smallint = 0,
    @ol_qty4 smallint = 0,
    @ol_qty5 smallint = 0,
    @ol_qty6 smallint = 0,
    @ol_qty7 smallint = 0,
    @ol_qty8 smallint = 0,
    @ol_qty9 smallint = 0,
    0, @ol_qty10 smallint = 0,
    0, @ol_qty11 smallint = 0,
    0, @ol_qty12 smallint = 0,
    0, @ol_qty13 smallint = 0,
```

```
    @i_id14 int = 0, @s_w_id14 smallint =
    @i_id15 int = 0, @s_w_id15 smallint =

    0, @ol_qty14 smallint = 0,
    0, @ol_qty15 smallint = 0

as
declare  @w_tax          numeric(4,4),
         @d_tax          numeric(4,4),
         @c_last         char(16),
         @c_credit       char(2),
         @c_discount     numeric(4,4),
         @i_price        numeric(5,2),
         @i_name         char(24),
         @i_data         char(50),
         @o_entry_d      datetime,
         @remote_flag    int,
         @s_quantity     smallint,
         @s_data         char(50),
         @s_dist         char(24),
         @li_no          int,
         @o_id           int,
         @commit_flag    tinyint,
         @li_id          int,
         @li_s_w_id      smallint,
         @li_qty         smallint,
         @ol_number      int,
         @c_id_local     int

begin

    begin transaction n

-- get district tax and next available order id and update
-- plus initialize local variables

        update  district
        set      @d_tax          = d_tax,
                 @o_id           = d_next_o_id,
                 d_next_o_id    = d_next_o_id + 1,
                 @o_entry_d      = getdate(),
                 @li_no          = 0,
                 @commit_flag    = 1
        where    d_w_id          = @w_id and
                 d_id           = @d_id

-- process orderlines

        while (@li_no < @o_ol_cnt)
            begin

                select @li_no = @li_no + 1

-- set i_id, s_w_id, and qty for this lineitem

                select @li_id = case @li_no
                           when 1 then @i_id1
                           when 2 then @i_id2
                           when 3 then @i_id3
                           when 4 then @i_id4
                           when 5 then @i_id5
                           when 6 then @i_id6
                           when 7 then @i_id7
```

Appendix B - Database Design

```
when 8 then @i_id8
when 9 then @i_id9
when 10 then @i_id10
when 11 then @i_id11
when 12 then @i_id12
when 13 then @i_id13
when 14 then @i_id14
when 15 then @i_id15
end,

@li_s_w_id = case @li_no
when 1 then @s_w_id1
when 2 then @s_w_id2
when 3 then @s_w_id3
when 4 then @s_w_id4
when 5 then @s_w_id5
when 6 then @s_w_id6
when 7 then @s_w_id7
when 8 then @s_w_id8
when 9 then @s_w_id9
when 10 then @s_w_id10
when 11 then @s_w_id11
when 12 then @s_w_id12
when 13 then @s_w_id13
when 14 then @s_w_id14
when 15 then @s_w_id15
end,

@li_qty = case @li_no
when 1 then @ol_qty1
when 2 then @ol_qty2
when 3 then @ol_qty3
when 4 then @ol_qty4
when 5 then @ol_qty5
when 6 then @ol_qty6
when 7 then @ol_qty7
when 8 then @ol_qty8
when 9 then @ol_qty9
when 10 then @ol_qty10
when 11 then @ol_qty11
when 12 then @ol_qty12
when 13 then @ol_qty13
when 14 then @ol_qty14
when 15 then @ol_qty15
end

-- get item data (no one updates item)
select @i_price = i_price,
       @i_name = i_name,
       @i_data = i_data
from item (tablock repeatableread)
where i_id = @li_id

-- update stock values
update stock
set s_ytd = s_ytd + @li_qty,
    @s_quantity = s_quantity -
@li_qty +
    case when (s_quantity - @li_qty < 10) then 91 else 0 end,
    s_order_cnt = s_order_cnt + 1,

s_remote_cnt = s_remote_cnt +
case when (@li_s_w_id = @w_id) then 0 else 1 end,
@s_data = s_data,
@s_dist = case @d_id
when 1
when 2 then s_dist_02
when 3 then s_dist_03
when 4 then s_dist_04
when 5 then s_dist_05
when 6 then s_dist_06
when 7 then s_dist_07
when 8 then s_dist_08
when 9 then s_dist_09
when 10 then s_dist_10
end
where s_i_id = @li_id and
       s_w_id = @li_s_w_id

-- if there actually is a stock (and item) with these ids, go to work
if (@@rowcount > 0)
begin
-- insert order_line data (using data from item and stock)
insert into order_line values(@o_id,
                               @d_id,
                               @w_id,
                               @li_no,
                               @li_id,
                               @li_s_w_id,
                               "dec 31, 1899",
                               @li_qty,
                               @i_price * @li_qty,
                               @s_dist)

-- send line-item data to client
select @i_name,
       @s_quantity,
       b_g = case when (
(patindex("%ORIGINAL%",@i_data) > 0) and
(patindex("%ORIGINAL%",@s_data) > 0) )
then "B" else "G"
end,
       @i_price,
       @i_price * @li_qty
else
end
```

Appendix B - Database Design

```
begin
-- no item (or stock) found - triggers rollback condition
    select "",0,"",0,0
    select @commit_flag = 0
end
end

-- get customer last name, discount, and credit rating
select      @c_last      = c_last,
            @c_discount = c_discount,
            @c_credit    = c_credit,
            @c_id_local  = c_id
from customer (repeatableread)
where c_id      = @c_id and
       c_w_id   = @w_id and
       c_d_id   = @d_id

-- insert fresh row into orders table
insert into orders values (@o_id,
                           @d_id,
                           @w_id,
                           @c_id_local,
                           @o_entry_d,
                           0,
                           @o_ol_cnt,
                           @o_all_local)

-- insert corresponding row into new-order table
insert into new_order values (@o_id,
                              @d_id,
                              @w_id)

-- select warehouse tax
select  @w_tax = w_tax
from    warehouse (repeatableread)
where   w_id   = @w_id

if (@commit_flag = 1)
    commit transaction n
else
    rollback transaction n

-- all that work for nuthin!!!

-- return order data to client
select @w_tax,
       @d_tax,
       @o_id,
       @c_last,
       @c_discount,
       @c_credit,
       @o_entry_d,
       @commit_flag
```

```
end
go

payment.sql

-- File:      PAYMENT.SQL
--           Microsoft TPC-C Benchmark Kit Ver. 4.00
--           Copyright Microsoft, 1996
-- Purpose:   Creates payment transaction stored procedure

use tpcc
go

if exists (select name from sysobjects where name = "tpcc_payment" )
    drop procedure tpcc_payment
go

create proc tpcc_payment @w_id          smallint,
                        @c_w_id        smallint,
                        @h_amount      numeric(6,2),
                        @d_id          tinyint,
                        @c_d_id        tinyint,
                        @c_id          int,
                        @c_last        char(16) =
''

as
declare @w_street_1 char(20),
        @w_street_2 char(20),
        @w_city     char(20),
        @w_state    char(2),
        @w_zip      char(9),
        @w_name     char(10),
        @d_street_1 char(20),
        @d_street_2 char(20),
        @d_city     char(20),
        @d_state    char(2),
        @d_zip      char(9),
        @d_name     char(10),
        @c_first    char(16),
        @c_middle   char(2),
        @c_street_1 char(20),
        @c_street_2 char(20),
        @c_city     char(20),
        @c_state    char(2),
        @c_zip      char(9),
        @c_phone    char(16),
        @c_since    datetime,
        @c_credit   char(2),
        @c_credit_lim numeric(12,2),
        @c_balance  numeric(12,2),
        @c_discount numeric(4,4),
        @data       char(500),
        @c_data     char(500),
        @datetime   datetime,
        @w_ytd      numeric(12,2),
```

Appendix B - Database Design

```
@d_ytd          numeric(12,2),
@cnt            smallint,
@val           smallint,
@screen_data   char(200),
               @d_id_local   tinyint,
               @w_id_local   smallint,
               @c_id_local   int

select @screen_data = ""

begin tran p

-- get payment date

select @datetime = getdate()

if (@c_id = 0)
begin

-- get customer id and info using last name

select @cnt = count(*)
from customer (repeatableread)
where c_last = @c_last and
      c_w_id = @c_w_id and
      c_d_id = @c_d_id

select @val = (@cnt + 1) / 2
set rowcount @val

select @c_id = c_id
from customer (repeatableread)
where c_last = @c_last and
      c_w_id = @c_w_id and
      c_d_id = @c_d_id
order by c_last, c_first

set rowcount 0
end

-- get customer info and update balances

update customer set
@c_balance      = c_balance - @h_amount,
c_payment_cnt   = c_payment_cnt + 1,
c_ytd_payment   = c_ytd_payment + @h_amount,
@c_first       = c_first,
@c_middle      = c_middle,
@c_last        = c_last,
@c_street_1    = c_street_1,
@c_street_2    = c_street_2,
@c_city        = c_city,
@c_state       = c_state,
@c_zip         = c_zip,
@c_phone       = c_phone,
@c_credit      = c_credit,
@c_credit_lim  = c_credit_lim,
@c_discount    = c_discount,
@c_since       = c_since,
@data          = c_data,
@c_id_local    = c_id
where c_id = @c_id and

      c_w_id = @c_w_id and
      c_d_id = @c_d_id

-- if customer has bad credit get some more info

if (@c_credit = "BC")
begin

-- compute new info

select @c_data = convert(char(5),@c_id) +
               convert(char(4),@c_d_id) +
               convert(char(5),@c_w_id) +
               convert(char(4),@d_id) +
               convert(char(5),@w_id) +
               convert(char(19),@h_amount) +
               substring(@data, 1, 458)

-- update customer info

update customer set
      c_data = @c_data
where c_id = @c_id and
      c_w_id = @c_w_id and
      c_d_id = @c_d_id

select @screen_data = substring (@c_data,1,200)

end

-- get district data and update year-to-date

update district
set d_ytd      = d_ytd + @h_amount,
@d_street_1   = d_street_1,
@d_street_2   = d_street_2,
@d_city       = d_city,
@d_state      = d_state,
@d_zip        = d_zip,
@d_name       = d_name,
@d_id_local   = d_id
where d_w_id = @w_id and
      d_id = @d_id

-- get warehouse data and update year-to-date

update warehouse
set w_ytd      = w_ytd + @h_amount,
@w_street_1   = w_street_1,
@w_street_2   = w_street_2,
@w_city       = w_city,
@w_state      = w_state,
@w_zip        = w_zip,
@w_name       = w_name,
@w_id_local   = w_id
where w_id = @w_id

-- create history record

insert into history values (@c_id_local,
                           @c_d_id,
                           @c_w_id,
                           @d_id_local,
```

Appendix B - Database Design

```
@w_id_local,
@datetime,
@h_amount,
+ " " + @d_name)
@w_name
commit tran p
-- return data to client
select @c_id,
@c_last,
@datetime,
@w_street_1,
@w_street_2,
@w_city,
@w_state,
@w_zip,
@d_street_1,
@d_street_2,
@d_city,
@d_state,
@d_zip,
@c_first,
@c_middle,
@c_street_1,
@c_street_2,
@c_city,
@c_state,
@c_zip,
@c_phone,
@c_since,
@c_credit,
@c_credit_lim,
@c_discount,
@c_balance,
@screen_data
go
```

ordstat.sql

```
-- File: ORDSTAT.SQL
-- Microsoft TPC-C Benchmark Kit Ver. 4.00
-- Copyright Microsoft, 1996
-- Purpose: Creates order status transaction stored procedure
use tpcc
go
if exists ( select name from sysobjects where name = "tpcc_orderstatus" )
drop procedure tpcc_orderstatus
go
create proc tpcc_orderstatus @w_id smallint,
```

```
tinyint,
int,
= ""
as
declare @c_balance numeric(12,2),
@c_first char(16),
@c_middle char(2),
@o_id int,
@o_entry_d datetime,
@o_carrier_id smallint,
@cnt smallint
begin tran o
if (@c_id = 0)
begin
-- get customer id and info using last name
select @cnt = (count(*)+1)/2
from customer (repeatableread)
where c_last = @c_last and
c_w_id = @w_id and
c_d_id = @d_id
set rowcount @cnt
select @c_id = c_id,
@c_balance = c_balance,
@c_first = c_first,
@c_last = c_last,
@c_middle = c_middle
from customer (repeatableread)
where c_last = @c_last and
c_w_id = @w_id and
c_d_id = @d_id
order by c_w_id, c_d_id, c_last, c_first
set rowcount 0
end
else
begin
-- get customer info if by id
select @c_balance = c_balance,
@c_first = c_first,
@c_middle = c_middle,
@c_last = c_last
from customer (repeatableread)
where c_id = @c_id and
c_d_id = @d_id and
c_w_id = @w_id
select @cnt = @@rowcount
end
```

Appendix B - Database Design

```
-- if no such customer
    if (@cnt = 0)
    begin
        raiserror("Customer not found",18,1)
        goto custnotfound
    end
-- get order info
    select @o_id = o_id,
           @o_entry_d = o_entry_d,
           @o_carrier_id = o_carrier_id
    from orders (serializable)
    where o_c_id = @c_id and
          o_d_id = @d_id and
          o_w_id = @w_id
    order by o_id asc
-- select order lines for the current order
    select ol_supply_w_id,
           ol_i_id,
           ol_quantity,
           ol_amount,
           ol_delivery_d
    from order_line (repeatable)
    where ol_o_id = @o_id and
          ol_d_id = @d_id and
          ol_w_id = @w_id

custnotfound:
commit tran o
-- return data to client
select @c_id,
       @c_last,
       @c_first,
       @c_middle,
       @o_entry_d,
       @o_carrier_id,
       @c_balance,
       @o_id

go
```

delivery.sql

```
-- File:      DELIVERY.SQL
-- Microsoft TPC-C Benchmark Kit Ver. 4.00
-- Copyright Microsoft, 1996
-- Purpose:   Creates delivery transaction stored procedure
```

```
use tpcc
go
if exists (select name from sysobjects where name = "tpcc_delivery" )
    drop procedure tpcc_delivery
go
create proc tpcc_delivery    @w_id            smallint,
                             @o_carrier_id  smallint
as
declare @d_id tinyint,
        @o_id int,
        @c_id int,
        @total numeric(12,2),
        @oid1 int,
        @oid2 int,
        @oid3 int,
        @oid4 int,
        @oid5 int,
        @oid6 int,
        @oid7 int,
        @oid8 int,
        @oid9 int,
        @oid10 int

select @d_id = 0

begin tran d

    while (@d_id < 10)
    begin

        select @d_id = @d_id + 1,
               @total = 0,
               @o_id = 0

                select top 1 @o_id = no_o_id
                from new_order (serializable uplock)
                where no_w_id = @w_id and
                      no_d_id = @d_id
                order by no_o_id asc

        if (@@rowcount <> 0)
        begin
-- claim the order for this district

            delete new_order
            where no_w_id = @w_id and
                  no_d_id = @d_id and
                  no_o_id = @o_id

-- set carrier_id on this order (and get customer id)

            update orders
            set o_carrier_id = @o_carrier_id,
                @c_id = o_c_id
            where o_w_id = @w_id and
                  o_d_id = @d_id and
                  o_id = @o_id
```

Appendix B - Database Design

```
-- set date in all lineitems for this order (and sum amounts)

update order_line
  set ol_delivery_d = getdate(),
      @total        = @total + ol_amount
where ol_w_id = @w_id and
      ol_d_id = @d_id and
      ol_o_id = @o_id

-- accumulate lineitem amounts for this order into customer

update customer
  set c_balance      = c_balance + @total,
      c_delivery_cnt = c_delivery_cnt + 1
where c_w_id = @w_id and
      c_d_id = @d_id and
      c_id   = @c_id

end

select @oid1 = case @d_id when 1 then @o_id else @oid1 end,
       @oid2 = case @d_id when 2 then @o_id else @oid2 end,
       @oid3 = case @d_id when 3 then @o_id else @oid3 end,
       @oid4 = case @d_id when 4 then @o_id else @oid4 end,
       @oid5 = case @d_id when 5 then @o_id else @oid5 end,
       @oid6 = case @d_id when 6 then @o_id else @oid6 end,
       @oid7 = case @d_id when 7 then @o_id else @oid7 end,
       @oid8 = case @d_id when 8 then @o_id else @oid8 end,
       @oid9 = case @d_id when 9 then @o_id else @oid9 end,
       @oid10 = case @d_id when 10 then @o_id else @oid10 end

end

commit tran d

-- return delivery data to client

select @oid1,
       @oid2,
       @oid3,
       @oid4,
       @oid5,
       @oid6,
       @oid7,
       @oid8,
       @oid9,
       @oid10

go
```

stocklev.sql

```
-- File:      STOCKLEV.SQL
--           Microsoft TPC-C Benchmark Kit Ver. 4.00
--           Copyright Microsoft, 1996
-- Purpose:   Creates stock level transaction stored procedure

use tpcc
go
```

```
if exists (select name from sysobjects where name = "tpcc_stocklevel" )
  drop procedure tpcc_stocklevel
go

create proc tpcc_stocklevel @w_id          smallint,
                           @d_id          tinyint,
                           @threshold    smallint
as

  declare @o_id_low int,
          @o_id_high int

  select @o_id_low = (d_next_o_id - 20),
         @o_id_high = (d_next_o_id - 1)
  from district
  where d_w_id = @w_id and
        d_id   = @d_id

  select count(distinct(s_i_id))
  from stock, order_line
  where ol_w_id = @w_id and
        ol_d_id = @d_id and
        ol_o_id between @o_id_low and @o_id_high and
        s_w_id = ol_w_id and
        s_i_id = ol_i_id and
        s_quantity < @threshold

go
```

Loader Source Code

tpcc.h

```
// File:      TPCC.H
//           Microsoft TPC-C Kit Ver. 4.00
//           Copyright Microsoft, 1996, 1997, 1998

// Purpose:   Header file for TPC-C database loader

// Build number of TPC Benchmark Kit
#define TPCKIT_VER "4.00"

// General headers
#include <windows.h>
#include <winbase.h>
#include <stdlib.h>
#include <stdio.h>
#include <process.h>
#include <stddef.h>
#include <stdarg.h>
#include <string.h>
```

Appendix B - Database Design

```

#include <time.h>
#include <sys\timeb.h>
#include <sys\types.h>

// ODBC headers
#include <sql.h>
#include <sqlext.h>
#include <odbcss.h>

// General constants
#define MILLI 1000
#define FALSE 0
#define TRUE 1
#define UNDEF -1
#define MINPRINTASCII 32
#define MAXPRINTASCII 126

// Default environment constants
#define SERVER ""
#define DATABASE "tpcc"
#define USER "sa"
#define PASSWORD ""

// Default loader arguments
#define BATCH 10000
#define DEFILDPACKSIZE 32768
#define ORDERS_PER_DIST 3000
#define LOADER_RES_FILE "logs\\load.out"
#define LOADER_NURAND_C 123
#define DEF_STARTING_WAREHOUSE 1
#define BUILD_INDEX 1 // build both data
and indexes
#define INDEX_ORDER 1 // build indexes
before load
#define SCALE_DOWN 0 // build a normal scale
database
#define INDEX_SCRIPT_PATH "scripts"

typedef struct
{
    char *server;
    char *database;
    char *user;
    char *password;
    BOOL tables_all;
    // set if loading all tables
    BOOL table_item;
    // set if loading ITEM table specifically
    BOOL table_warehouse; // set if loading
WAREHOUSE, DISTRICT, and STOCK
    BOOL table_customer; // set if
loading CUSTOMER and HISTORY
    BOOL table_orders; // set if
loading NEW-ORDER, ORDERS, ORDER-LINE
    long num_warehouses;
    long batch;
    long verbose;
    long pack_size;
    char *loader_res_file;
    char *synch_servername;
    long case_sensitivity;
    long starting_warehouse;
    long build_index;

```

```

long index_order;
long scale_down;
char *index_script_path;
} TPCCCLR_ARGS;

// String length constants
#define SERVER_NAME_LEN 20
#define DATABASE_NAME_LEN 20
#define USER_NAME_LEN 20
#define PASSWORD_LEN 20
#define TABLE_NAME_LEN 20
#define I_DATA_LEN 50
#define I_NAME_LEN 24
#define BRAND_LEN 1
#define LAST_NAME_LEN 16
#define W_NAME_LEN 10
#define ADDRESS_LEN 20
#define STATE_LEN 2
#define ZIP_LEN 9
#define S_DIST_LEN 24
#define S_DATA_LEN 50
#define D_NAME_LEN 10
#define FIRST_NAME_LEN 16
#define MIDDLE_NAME_LEN 2
#define PHONE_LEN 16
#define CREDIT_LEN 2
#define C_DATA_LEN 500
#define H_DATA_LEN 24
#define DIST_INFO_LEN 24
#define MAX_OL_NEW_ORDER_ITEMS 15
#define MAX_OL_ORDER_STATUS_ITEMS 15
#define STATUS_LEN 25
#define OL_DIST_INFO_LEN 24
#define C_SINCE_LEN 23
#define H_DATE_LEN 23
#define OL_DELIVERY_D_LEN 23
#define O_ENTRY_D_LEN 23

// Functions in random.c
void seed();
long irand();
double drand();
void WUCreate();
short WURand();
long RandomNumber(long lower, long upper);

// Functions in getargs.c;
void GetArgsLoader();
void GetArgsLoaderUsage();

// Functions in time.c
long TimeNow();

// Functions in strings.c
void MakeAddress();
void LastName();
int MakeAlphaString();
int MakeOriginalAlphaString();
int MakeNumberString();
int MakeZipNumberString();
void InitString();
void InitAddress();

```

Appendix B - Database Design

```
void PaddString();
```

tpccldr.c

```
// File: TPCCLDR.C
// Microsoft TPC-C Kit Ver. 4.00
// Copyright Microsoft, 1996, 1997, 1998
// Purpose: Source file for TPC-C database loader

// Includes
#include "tpcc.h"
#include "search.h"

// Defines
#define MAXITEMS 100000
#define MAXITEMS_SCALE_DOWN 100
#define CUSTOMERS_PER_DISTRICT 3000
#define CUSTOMERS_SCALE_DOWN 30
#define DISTRICT_PER_WAREHOUSE 10
#define ORDERS_PER_DISTRICT 3000
#define ORDERS_SCALE_DOWN 30
#define MAX_CUSTOMER_THREADS 2
#define MAX_ORDER_THREADS 3
#define MAX_MAIN_THREADS 4

// Functions declarations

void HandleErrorDBC (SQLHDBC hdbc1);

long NURand();
void LoadItem();
void LoadWarehouse();

void Stock();
void District();

void LoadCustomer();
void CustomerBufInit();
void CustomerBufLoad();
void LoadCustomerTable();
void LoadHistoryTable();

void LoadOrders();
void OrdersBufInit();
void OrdersBufLoad();
void LoadOrdersTable();
void LoadNewOrderTable();
void LoadOrderLineTable();
void GetPermutation();
void CheckForCommit();
void OpenConnections();
void BuildIndex();
void FormatDate ();
```

```
// Shared memory structures

typedef struct
{
    long ol;
    long ol_i_id;
    short ol_supply_w_id;
    short ol_quantity;
    double ol_amount;
    char ol_dist_info[DIST_INFO_LEN+1];
    char ol_delivery_d[OL_DELIVERY_D_LEN+1];
} ORDER_LINE_STRUCT;

typedef struct
{
    long o_id;
    short o_d_id;
    short o_w_id;
    long o_c_id;
    short o_carrier_id;
    short o_ol_cnt;
    short o_all_local;
    ORDER_LINE_STRUCT o_ol[15];
} ORDERS_STRUCT;

typedef struct
{
    long c_id;
    short c_d_id;
    short c_w_id;
    char c_first[FIRST_NAME_LEN+1];
    char c_middle[MIDDLE_NAME_LEN+1];
    char c_last[LAST_NAME_LEN+1];
    char c_street_1[ADDRESS_LEN+1];
    char c_street_2[ADDRESS_LEN+1];
    char c_city[ADDRESS_LEN+1];
    char c_state[STATE_LEN+1];
    char c_zip[ZIP_LEN+1];
    char c_phone[PHONE_LEN+1];
    char c_credit[CREDIT_LEN+1];
    double c_credit_lim;
    double c_discount;
    // fix to avoid ODBC float to numeric conversion problem.
    // double c_balance;
    char c_balance[6];

    double c_ytd_payment;
    short c_payment_cnt;
    short c_delivery_cnt;
    char c_data[C_DATA_LEN+1];
    double h_amount;
    char h_data[H_DATA_LEN+1];
} CUSTOMER_STRUCT;

typedef struct
{
    char c_last[LAST_NAME_LEN+1];
    char c_first[FIRST_NAME_LEN+1];
    long c_id;
} CUSTOMER_SORT_STRUCT;

typedef struct
{
```

Appendix B - Database Design

```
    long          time_start;
} LOADER_TIME_STRUCT;

// Global variables

char          szLastError[300];

HENV          henv;

HDBC          i_hdbc1;          // for ITEM table
HDBC          w_hdbc1;          // for WAREHOUSE, DISTRICT,
STOCK
HDBC          c_hdbc1;          // for CUSTOMER
HDBC          c_hdbc2;          // for HISTORY
HDBC          o_hdbc1;          // for ORDERS
HDBC          o_hdbc2;          // for NEW-ORDER

HDBC          o_hdbc3;          // for ORDER-LINE

HSTMT         i_hstmt1;
HSTMT         w_hstmt1;
HSTMT         c_hstmt1, c_hstmt2;
HSTMT         o_hstmt1, o_hstmt2, o_hstmt3;

ORDERS_STRUCT orders_buf[ORDERS_PER_DISTRICT];
CUSTOMER_STRUCT customer_buf[CUSTOMERS_PER_DISTRICT];
long          orders_rows_loaded;
long          new_order_rows_loaded;
long          order_line_rows_loaded;
long          history_line_loaded;
long          customer_rows_loaded;
long          stock_rows_loaded;
long          district_rows_loaded;
long          item_rows_loaded;
long          warehouse_rows_loaded;
long          main_time_start;
long          main_time_end;
long          max_items;
long          customers_per_district;
long          orders_per_district;
long          first_new_order;
long          last_new_order;

TPCCLDR_ARGS  *aptr, args;

//=====
//
// Function name: main
//
//=====

int main(int argc, char **argv)
{
    DWORD          dwThreadID[MAX_MAIN_THREADS];
    HANDLE          hThread[MAX_MAIN_THREADS];
    FILE           *fLoader;
    char           buffer[255];
    int            i;
```

```
    for (i=0; i<MAX_MAIN_THREADS; i++)
        hThread[i] = NULL;

    printf("\n*****");
    printf("\n*          *");
    printf("\n* Microsoft SQL Server *");
    printf("\n*          *");
    printf("\n* TPC-C BENCHMARK KIT: Database loader *");
    printf("\n* Version %s *", TPCKIT_VER);
    printf("\n*          *");
    printf("\n*****\n\n");

    // process command line arguments

    aptr = &args;
    GetArgsLoader(argc, argv, aptr);

    printf("Build interface is ODBC.\n");

    if (aptr->build_index == 0)
        printf("Data load only - no index creation.\n");
    else
        printf("Data load and index creation.\n");

    if (aptr->index_order == 0)
        printf("Clustered indexes will be created after bulk load.\n");
    else
        printf("Clustered indexes will be created before bulk load.\n");

    // set database scale values
    if (aptr->scale_down == 1)
    {
        printf("**** Scaled Down Database ****\n");
        max_items = MAXITEMS_SCALE_DOWN;
        customers_per_district = CUSTOMERS_SCALE_DOWN;
        orders_per_district = ORDERS_SCALE_DOWN;
        first_new_order = 0;
        last_new_order = 30;
    }
    else
    {
        max_items = MAXITEMS;
        customers_per_district = CUSTOMERS_PER_DISTRICT;
        orders_per_district = ORDERS_PER_DISTRICT;
        first_new_order = 2100;
        last_new_order = 3000;
    }

    // open connections to SQL Server
    OpenConnections();

    // open file for loader results
    fLoader = fopen(aptr->loader_res_file, "w");

    if (fLoader == NULL)
    {
        printf("Error, loader result file open failed.");
        exit(-1);
    }

    // start loading data
```

Appendix B - Database Design

```
    sprintf(buffer, "TPC-C load started for %ld warehouses.\n", aptr->num_warehouses);
    printf("%s", buffer);
    fprintf(fLoader, "%s", buffer);
    main_time_start = (TimeNow() / MILLI);
    // start parallel load threads

    if (aptr->tables_all || aptr->table_item)
    {
        fprintf(fLoader, "\nStarting loader threads for: item\n");
        hThread[0] = CreateThread(NULL,
                                0,
                                (LPTHREAD_START_ROUTINE) LoadItem,
                                NULL,
                                0,
                                &dwThreadID[0]);
        if (hThread[0] == NULL)
        {
            printf("Error, failed in creating creating thread = 0.\n");
            exit(-1);
        }
    }
    if (aptr->tables_all || aptr->table_warehouse)
    {
        fprintf(fLoader, "Starting loader threads for: warehouse\n");
        hThread[1] = CreateThread(NULL,
                                0,
                                (LPTHREAD_START_ROUTINE) LoadWarehouse,
                                NULL,
                                0,
                                &dwThreadID[1]);
        if (hThread[1] == NULL)
        {
            printf("Error, failed in creating creating thread = 1.\n");
            exit(-1);
        }
    }
    if (aptr->tables_all || aptr->table_customer)
    {
        fprintf(fLoader, "Starting loader threads for: customer\n");
        hThread[2] = CreateThread(NULL,
                                0,
                                (LPTHREAD_START_ROUTINE) LoadCustomer,
                                NULL,
                                0,
                                &dwThreadID[2]);
        if (hThread[2] == NULL)
        {
            printf("Error, failed in creating creating main thread =
2.\n");
        }
    }
    if (aptr->tables_all || aptr->table_orders)
    {
        fprintf(fLoader, "Starting loader threads for: orders\n");
        hThread[3] = CreateThread(NULL,
                                0,
                                (LPTHREAD_START_ROUTINE) LoadOrders,
                                NULL,
                                0,
                                &dwThreadID[3]);
        if (hThread[3] == NULL)
        {
            printf("Error, failed in creating creating main thread =
3.\n");
            exit(-1);
        }
    }
    // Wait for threads to finish...
    for (i=0; i<MAX_MAIN_THREADS; i++)
    {
        if (hThread[i] != NULL)
        {
            WaitForSingleObject( hThread[i], INFINITE );
            CloseHandle(hThread[i]);
            hThread[i] = NULL;
        }
    }
    main_time_end = (TimeNow() / MILLI);
    sprintf(buffer, "\nTPC-C load completed successfully in %ld minutes.\n",
            (main_time_end - main_time_start)/60);
    printf("%s", buffer);
    fprintf(fLoader, "%s", buffer);
    fclose(fLoader);
    SQLFreeEnv(henv);
    exit(0);
    return 0;
}
//=====
//
// Function name: LoadItem
//
//=====
```

Appendix B - Database Design

```
void LoadItem()
{
    long          i_id;
    long          i_im_id;
    char          i_name[I_NAME_LEN+1];
    double        i_price;
    char          i_data[I_DATA_LEN+1];
    char          name[20];
    long          time_start;
    RETCODE       rc;
    DBINT         rcint;
    char          bcp hint[128];

    // Seed with unique number
    seed(1);

    printf("Loading item table...\n");

    // if build index before load
    if ((aptr->build_index == 1) && (aptr->index_order == 1))
        BuildIndex("idxitmcl");

    InitString(i_name, I_NAME_LEN+1);
    InitString(i_data, I_DATA_LEN+1);

    sprintf(name, "%s..%s", aptr->database, "item");

    rc = bcp_init(i_hdbc1, name, NULL, "logs\\item.err", DB_IN);
    if (rc != SUCCEED)
        HandleErrorDBC(i_hdbc1);

    if ((aptr->build_index == 1) && (aptr->index_order == 1))
    {
        sprintf(bcp hint, "tablock, order (i_id), ROWS_PER_BATCH = 100000");
        rc = bcp_control(i_hdbc1, BCPHINTS, (void*) bcp hint);
        if (rc != SUCCEED)
            HandleErrorDBC(i_hdbc1);
    }

1);
    rc = bcp_bind(i_hdbc1, (BYTE *) &i_id, 0, SQL_VARLEN_DATA, NULL, 0, SQLINT4,
    if (rc != SUCCEED)
        HandleErrorDBC(i_hdbc1);

2);
    rc = bcp_bind(i_hdbc1, (BYTE *) &i_im_id, 0, SQL_VARLEN_DATA, NULL, 0, SQLINT4,
    if (rc != SUCCEED)
        HandleErrorDBC(i_hdbc1);

    rc = bcp_bind(i_hdbc1, (BYTE *) i_name, 0, I_NAME_LEN, NULL, 0, 0, 3);
    if (rc != SUCCEED)
        HandleErrorDBC(i_hdbc1);

4);
    rc = bcp_bind(i_hdbc1, (BYTE *) &i_price, 0, SQL_VARLEN_DATA, NULL, 0, SQLFLT8,
    if (rc != SUCCEED)
        HandleErrorDBC(i_hdbc1);

    rc = bcp_bind(i_hdbc1, (BYTE *) i_data, 0, I_DATA_LEN, NULL, 0, 0, 5);
    if (rc != SUCCEED)
        HandleErrorDBC(i_hdbc1);
```

```
time_start = (TimeNow() / MILLI);

item_rows_loaded = 0;

for (i_id = 1; i_id <= max_items; i_id++)
{
    i_im_id = RandomNumber(1L, 10000L);

    MakeAlphaString(14, 24, I_NAME_LEN, i_name);

    i_price = ((float) RandomNumber(100L, 10000L))/100.0;

    MakeOriginalAlphaString(26, 50, I_DATA_LEN, i_data, 10);

    rc = bcp_sendrow(i_hdbc1);
    if (rc != SUCCEED)
        HandleErrorDBC(i_hdbc1);

    item_rows_loaded++;
    CheckForCommit(i_hdbc1, i_hstmt1, item_rows_loaded, "item",
&time_start);
}

rcint = bcp_done(i_hdbc1);
if (rcint < 0)
    HandleErrorDBC(i_hdbc1);

printf("Finished loading item table.\n");

SQLFreeStmt(i_hstmt1, SQL_DROP);
SQLDisconnect(i_hdbc1);
SQLFreeConnect(i_hdbc1);

// if build index after load
if ((aptr->build_index == 1) && (aptr->index_order == 0))
    BuildIndex("idxitmcl");
}

//=====
//
// Function : LoadWarehouse
//
// Loads WAREHOUSE table and loads Stock and District as Warehouses are created
//
//=====

void LoadWarehouse()
{
    short w_id;
    char w_name[W_NAME_LEN+1];
    char w_street_1[ADDRESS_LEN+1];
    char w_street_2[ADDRESS_LEN+1];
    char w_city[ADDRESS_LEN+1];
    char w_state[STATE_LEN+1];
    char w_zip[ZIP_LEN+1];
    double w_tax;
    double w_ytd;
    char name[20];
    long time_start;
    RETCODE rc;
    DBINT rcint;
```

Appendix B - Database Design

```
char    bcphint[128];

// Seed with unique number
seed(2);

printf("Loading warehouse table...\n");

// if build index before load...
if ((aptr->build_index == 1) && (aptr->index_order == 1))
    BuildIndex("idxwarcl");

InitString(w_name, W_NAME_LEN+1);
InitAddress(w_street_1, w_street_2, w_city, w_state, w_zip);

sprintf(name, "%s..%s", aptr->database, "warehouse");

rc = bcp_init(w_hdbc1, name, NULL, "logs\\whouse.err", DB_IN);
if (rc != SUCCEED)
    HandleErrorDBC(w_hdbc1);

if ((aptr->build_index == 1) && (aptr->index_order == 1))
{
    sprintf(bcphint, "tablock, order (w_id), ROWS_PER_BATCH = %d", aptr->num_warehouses);
    rc = bcp_control(w_hdbc1, BCPHINTS, (void*) bcphint);
    if (rc != SUCCEED)
        HandleErrorDBC(w_hdbc1);
}

rc = bcp_bind(w_hdbc1, (BYTE *) &w_id, 0, SQL_VARLEN_DATA, NULL, 0, SQLINT2,
1);
if (rc != SUCCEED)
    HandleErrorDBC(w_hdbc1);

rc = bcp_bind(w_hdbc1, (BYTE *) w_name, 0, W_NAME_LEN, NULL, 0, 0, 2);
if (rc != SUCCEED)
    HandleErrorDBC(w_hdbc1);

rc = bcp_bind(w_hdbc1, (BYTE *) w_street_1, 0, ADDRESS_LEN, NULL, 0, 0, 3);
if (rc != SUCCEED)
    HandleErrorDBC(w_hdbc1);

rc = bcp_bind(w_hdbc1, (BYTE *) w_street_2, 0, ADDRESS_LEN, NULL, 0, 0, 4);
if (rc != SUCCEED)
    HandleErrorDBC(w_hdbc1);

rc = bcp_bind(w_hdbc1, (BYTE *) w_city, 0, ADDRESS_LEN, NULL, 0, 0, 5);
if (rc != SUCCEED)
    HandleErrorDBC(w_hdbc1);

rc = bcp_bind(w_hdbc1, (BYTE *) w_state, 0, STATE_LEN, NULL, 0, 0, 6);
if (rc != SUCCEED)
    HandleErrorDBC(w_hdbc1);

rc = bcp_bind(w_hdbc1, (BYTE *) w_zip, 0, ZIP_LEN, NULL, 0, 0, 7);
if (rc != SUCCEED)
    HandleErrorDBC(w_hdbc1);

rc = bcp_bind(w_hdbc1, (BYTE *) &w_tax, 0, SQL_VARLEN_DATA, NULL, 0, SQLFLT8,
8);
if (rc != SUCCEED)
    HandleErrorDBC(w_hdbc1);
```

```
9);
rc = bcp_bind(w_hdbc1, (BYTE *) &w_ytd, 0, SQL_VARLEN_DATA, NULL, 0, SQLFLT8,
if (rc != SUCCEED)
    HandleErrorDBC(w_hdbc1);

time_start = (TimeNow() / MILLI);

warehouse_rows_loaded = 0;

for (w_id = (short)aptr->starting_warehouse; w_id <= aptr->num_warehouses;
w_id++)
{
    MakeAlphaString(6,10, W_NAME_LEN, w_name);
    MakeAddress(w_street_1, w_street_2, w_city, w_state, w_zip);

    w_tax = ((float) RandomNumber(0L,2000L))/10000.00;
    w_ytd = 300000.00;

    rc = bcp_sendrow(w_hdbc1);
    if (rc != SUCCEED)
        HandleErrorDBC(w_hdbc1);

    warehouse_rows_loaded++;
    CheckForCommit(w_hdbc1, i_hstmt1, warehouse_rows_loaded, "warehouse",
&time_start);
}

rcint = bcp_done(w_hdbc1);
if (rcint < 0)
    HandleErrorDBC(w_hdbc1);

printf("Finished loading warehouse table.\n");

// if build index after load...
if ((aptr->build_index == 1) && (aptr->index_order == 0))
    BuildIndex("idxwarcl");

stock_rows_loaded = 0;
district_rows_loaded = 0;

District();
Stock();

}

//=====
//
// Function : District
//
//=====

void District()
{
    short d_id;
    short d_w_id;
    char d_name[D_NAME_LEN+1];
    char d_street_1[ADDRESS_LEN+1];
    char d_street_2[ADDRESS_LEN+1];
    char d_city[ADDRESS_LEN+1];
```

Appendix B - Database Design

```
char d_state[STATE_LEN+1];
char d_zip[ZIP_LEN+1];
double d_tax;
double d_ytd;
char name[20];
long d_next_o_id;
long time_start;
int w_id;
RETCODE rc;
DBINT rcint;
char bcp[128];

// Seed with unique number
seed(4);

printf("Loading district table...\n");

// build index before load
if ((aptr->build_index == 1) && (aptr->index_order == 1))
    BuildIndex("idxdiscl");

InitString(d_name, D_NAME_LEN+1);
InitAddress(d_street_1, d_street_2, d_city, d_state, d_zip);
sprintf(name, "%s..%s", aptr->database, "district");

rc = bcp_init(w_hdbc1, name, NULL, "logs\\district.err", DB_IN);
if (rc != SUCCEEDED)
    HandleErrorDBC(w_hdbc1);

if ((aptr->build_index == 1) && (aptr->index_order == 1))
{
    sprintf(bcp, "tablock, order (d_w_id, d_id), ROWS_PER_BATCH =
%u", (aptr->num_warehouses * 10));
    rc = bcp_control(w_hdbc1, BCPHINTS, (void*) bcp);
    if (rc != SUCCEEDED)
        HandleErrorDBC(w_hdbc1);
}

1); rc = bcp_bind(w_hdbc1, (BYTE *) &d_id, 0, SQL_VARLEN_DATA, NULL, 0, SQLINT2,
    if (rc != SUCCEEDED)
        HandleErrorDBC(w_hdbc1);

2); rc = bcp_bind(w_hdbc1, (BYTE *) &d_w_id, 0, SQL_VARLEN_DATA, NULL, 0, SQLINT2,
    if (rc != SUCCEEDED)
        HandleErrorDBC(w_hdbc1);

rc = bcp_bind(w_hdbc1, (BYTE *) d_name, 0, D_NAME_LEN, NULL, 0, 0, 3);
if (rc != SUCCEEDED)
    HandleErrorDBC(w_hdbc1);

rc = bcp_bind(w_hdbc1, (BYTE *) d_street_1, 0, ADDRESS_LEN, NULL, 0, 0, 4);
if (rc != SUCCEEDED)
    HandleErrorDBC(w_hdbc1);

rc = bcp_bind(w_hdbc1, (BYTE *) d_street_2, 0, ADDRESS_LEN, NULL, 0, 0, 5);
if (rc != SUCCEEDED)
    HandleErrorDBC(w_hdbc1);

rc = bcp_bind(w_hdbc1, (BYTE *) d_city, 0, ADDRESS_LEN, NULL, 0, 0, 6);
if (rc != SUCCEEDED)
    HandleErrorDBC(w_hdbc1);
```

```
rc = bcp_bind(w_hdbc1, (BYTE *) d_state, 0, STATE_LEN, NULL, 0, 0, 7);
if (rc != SUCCEEDED)
    HandleErrorDBC(w_hdbc1);

rc = bcp_bind(w_hdbc1, (BYTE *) d_zip, 0, ZIP_LEN, NULL, 0, 0, 8);
if (rc != SUCCEEDED)
    HandleErrorDBC(w_hdbc1);

9); rc = bcp_bind(w_hdbc1, (BYTE *) &d_tax, 0, SQL_VARLEN_DATA, NULL, 0, SQLFLT8,
    if (rc != SUCCEEDED)
        HandleErrorDBC(w_hdbc1);

10); rc = bcp_bind(w_hdbc1, (BYTE *) &d_ytd, 0, SQL_VARLEN_DATA, NULL, 0, SQLFLT8,
    if (rc != SUCCEEDED)
        HandleErrorDBC(w_hdbc1);

SQLINT4, 11); rc = bcp_bind(w_hdbc1, (BYTE *) &d_next_o_id, 0, SQL_VARLEN_DATA, NULL, 0,
    if (rc != SUCCEEDED)
        HandleErrorDBC(w_hdbc1);

d_ytd = 30000.0;
d_next_o_id = orders_per_district+1;
time_start = (TimeNow() / MILLI);

for (w_id = aptr->starting_warehouse; w_id <= aptr->num_warehouses; w_id++)
{
    d_w_id = w_id;
    for (d_id = 1; d_id <= DISTRICT_PER_WAREHOUSE; d_id++)
    {
        MakeAlphaString(6,10,D_NAME_LEN, d_name);
        MakeAddress(d_street_1, d_street_2, d_city, d_state,
            d_tax = ((float) RandomNumber(0L,2000L))/10000.00;
        rc = bcp_sendrow(w_hdbc1);
        if (rc != SUCCEEDED)
            HandleErrorDBC(w_hdbc1);
        district_rows_loaded++;
        CheckForCommit(w_hdbc1, w_hstmt1, district_rows_loaded,
            "district", &time_start);
    }
}

rcint = bcp_done(w_hdbc1);
if (rcint < 0)
    HandleErrorDBC(w_hdbc1);

printf("Finished loading district table.\n");

// if build index after load...
if ((aptr->build_index == 1) && (aptr->index_order == 0))
    BuildIndex("idxdiscl");
```

Appendix B - Database Design

```
return;
}

//=====
//
// Function   : Stock
//
//=====

void Stock()
{
    long  s_i_id;
    short s_w_id;
    short s_quantity;
    char  s_dist_01[S_DIST_LEN+1];
    char  s_dist_02[S_DIST_LEN+1];
    char  s_dist_03[S_DIST_LEN+1];
    char  s_dist_04[S_DIST_LEN+1];
    char  s_dist_05[S_DIST_LEN+1];
    char  s_dist_06[S_DIST_LEN+1];
    char  s_dist_07[S_DIST_LEN+1];
    char  s_dist_08[S_DIST_LEN+1];
    char  s_dist_09[S_DIST_LEN+1];
    char  s_dist_10[S_DIST_LEN+1];
    long  s_ytd;
    short s_order_cnt;
    short s_remote_cnt;
    char  s_data[S_DATA_LEN+1];
    short len;
    char  name[20];
    long  time_start;
    RETCODE rc;
    DBINT  rcint;
    char  bcphint[128];

    // Seed with unique number
    seed(3);

    // if build index before load...
    if ((aptr->build_index == 1) && (aptr->index_order == 1))
        BuildIndex("idxstkcl");

    sprintf(name, "%s.%s", aptr->database, "stock");

    rc = bcp_init(w_hdbc1, name, NULL, "logs\\stock.err", DB_IN);
    if (rc != SUCCEED)
        HandleErrorDBC(w_hdbc1);

    if ((aptr->build_index == 1) && (aptr->index_order == 1))
    {
        sprintf(bcphint, "tablock, order (s_i_id, s_w_id), ROWS_PER_BATCH =
%u", (aptr->num_warehouses * 100000));
        rc = bcp_control(w_hdbc1, BCPHINTS, (void*) bcphint);
        if (rc != SUCCEED)
            HandleErrorDBC(w_hdbc1);
    }

    rc = bcp_bind(w_hdbc1, (BYTE *) &s_i_id, 0, SQL_VARLEN_DATA, NULL, 0, SQLINT4,
1);
    if (rc != SUCCEED)
        HandleErrorDBC(w_hdbc1);
```

```
bcp_bind(w_hdbc1, (BYTE *) &s_w_id, 0, SQL_VARLEN_DATA, NULL, 0, SQLINT2, 2);
    if (rc != SUCCEED)
        HandleErrorDBC(w_hdbc1);

    rc = bcp_bind(w_hdbc1, (BYTE *) &s_quantity, 0, SQL_VARLEN_DATA, NULL, 0,
SQLINT2, 3);
    if (rc != SUCCEED)
        HandleErrorDBC(w_hdbc1);

    rc = bcp_bind(w_hdbc1, (BYTE *) s_dist_01, 0, S_DIST_LEN, NULL, 0, 0, 4);
    if (rc != SUCCEED)
        HandleErrorDBC(w_hdbc1);

    rc = bcp_bind(w_hdbc1, (BYTE *) s_dist_02, 0, S_DIST_LEN, NULL, 0, 0, 5);
    if (rc != SUCCEED)
        HandleErrorDBC(w_hdbc1);

    rc = bcp_bind(w_hdbc1, (BYTE *) s_dist_03, 0, S_DIST_LEN, NULL, 0, 0, 6);
    if (rc != SUCCEED)
        HandleErrorDBC(w_hdbc1);

    rc = bcp_bind(w_hdbc1, (BYTE *) s_dist_04, 0, S_DIST_LEN, NULL, 0, 0, 7);
    if (rc != SUCCEED)
        HandleErrorDBC(w_hdbc1);

    rc = bcp_bind(w_hdbc1, (BYTE *) s_dist_05, 0, S_DIST_LEN, NULL, 0, 0, 8);
    if (rc != SUCCEED)
        HandleErrorDBC(w_hdbc1);

    rc = bcp_bind(w_hdbc1, (BYTE *) s_dist_06, 0, S_DIST_LEN, NULL, 0, 0, 9);
    if (rc != SUCCEED)
        HandleErrorDBC(w_hdbc1);

    rc = bcp_bind(w_hdbc1, (BYTE *) s_dist_07, 0, S_DIST_LEN, NULL, 0, 0, 10);
    if (rc != SUCCEED)
        HandleErrorDBC(w_hdbc1);

    rc = bcp_bind(w_hdbc1, (BYTE *) s_dist_08, 0, S_DIST_LEN, NULL, 0, 0, 11);
    if (rc != SUCCEED)
        HandleErrorDBC(w_hdbc1);

    rc = bcp_bind(w_hdbc1, (BYTE *) s_dist_09, 0, S_DIST_LEN, NULL, 0, 0, 12);
    if (rc != SUCCEED)
        HandleErrorDBC(w_hdbc1);

    rc = bcp_bind(w_hdbc1, (BYTE *) s_dist_10, 0, S_DIST_LEN, NULL, 0, 0, 13);
    if (rc != SUCCEED)
        HandleErrorDBC(w_hdbc1);

    rc = bcp_bind(w_hdbc1, (BYTE *) &s_ytd, 0, SQL_VARLEN_DATA, NULL, 0, SQLINT4,
14);
    if (rc != SUCCEED)
        HandleErrorDBC(w_hdbc1);

    rc = bcp_bind(w_hdbc1, (BYTE *) &s_order_cnt, 0, SQL_VARLEN_DATA, NULL, 0,
SQLINT2, 15);
    if (rc != SUCCEED)
        HandleErrorDBC(w_hdbc1);

    rc = bcp_bind(w_hdbc1, (BYTE *) &s_remote_cnt, 0, SQL_VARLEN_DATA, NULL, 0,
SQLINT2, 16);
    if (rc != SUCCEED)
        HandleErrorDBC(w_hdbc1);
```

Appendix B - Database Design

```
rc = bcp_bind(w_hdbc1, (BYTE *) s_data, 0, S_DATA_LEN, NULL, 0, 0, 17);
if (rc != SUCCEED)
    HandleErrorDBC(w_hdbc1);

s_ytd = s_order_cnt = s_remote_cnt = 0;

time_start = (TimeNow() / MILLI);

printf("...Loading stock table\n");

for (s_i_id=1; s_i_id <= max_items; s_i_id++)
{
    for (s_w_id = (short)aptr->starting_warehouse; s_w_id <= aptr-
>num_warehouses; s_w_id++)
    {
        s_quantity = (short)RandomNumber(10L,100L);
        len = MakeAlphaString(24,24,S_DIST_LEN, s_dist_01);
        len = MakeAlphaString(24,24,S_DIST_LEN, s_dist_02);
        len = MakeAlphaString(24,24,S_DIST_LEN, s_dist_03);
        len = MakeAlphaString(24,24,S_DIST_LEN, s_dist_04);
        len = MakeAlphaString(24,24,S_DIST_LEN, s_dist_05);
        len = MakeAlphaString(24,24,S_DIST_LEN, s_dist_06);
        len = MakeAlphaString(24,24,S_DIST_LEN, s_dist_07);
        len = MakeAlphaString(24,24,S_DIST_LEN, s_dist_08);
        len = MakeAlphaString(24,24,S_DIST_LEN, s_dist_09);
        len = MakeAlphaString(24,24,S_DIST_LEN, s_dist_10);

        len = MakeOriginalAlphaString(26,50, S_DATA_LEN,
s_data,10);

        rc = bcp_sendrow(w_hdbc1);
        if (rc != SUCCEED)
            HandleErrorDBC(w_hdbc1);

        stock_rows_loaded++;
        CheckForCommit(w_hdbc1, w_hstmt1, stock_rows_loaded,
"stock", &time_start);
    }
}

rcint = bcp_done(w_hdbc1);
if (rcint < 0)
    HandleErrorDBC(w_hdbc1);

printf("Finished loading stock table.\n");

SQLFreeStmt(w_hstmt1, SQL_DROP);
SQLDisconnect(w_hdbc1);
SQLFreeConnect(w_hdbc1);

// if build index after load...
if ((aptr->build_index == 1) && (aptr->index_order == 0))
    BuildIndex("idxstkcl");

return;
}

//=====
```

```
//
// Function : LoadCustomer
//
//=====

void LoadCustomer()
{
    LOADER_TIME_STRUCT customer_time_start;
    LOADER_TIME_STRUCT history_time_start;
    short w_id;
    short d_id;
    DWORD dwThreadId[MAX_CUSTOMER_THREADS];
    HANDLE hThread[MAX_CUSTOMER_THREADS];
    char name[20];
    RETCODE rc;
    DBINT rcint;
    char bcphint[128];
    char cmd[256];
    char rc_l;
    // SQLRETURN // SQLSMALLINT // SQLCHAR // SQLINTEGER
    Msg[SQL_MAX_MESSAGE_LENGTH]; // NativeError;

    // Seed with unique number
    seed(5);

    printf("Loading customer and history tables...\n");

    // if build index before load...
    if ((aptr->build_index == 1) && (aptr->index_order == 1))
        BuildIndex("idxcuscl");

    // Initialize bulk copy
    sprintf(name, "%s.%s", aptr->database, "customer");

    rc = bcp_init(c_hdbc1, name, NULL, "logs\\customer.err", DB_IN);
    if (rc != SUCCEED)
        HandleErrorDBC(c_hdbc1);

    if ((aptr->build_index == 1) && (aptr->index_order == 1))
    {
        sprintf(bcphint, "tablock, order (c_w_id, c_d_id, c_id),
ROWS_PER_BATCH = %u", (aptr->num_warehouses * 30000));
        rc = bcp_control(c_hdbc1, BCPHINTS, (void*) bcphint);
        if (rc != SUCCEED)
            HandleErrorDBC(c_hdbc1);
    }

    sprintf(name, "%s.%s", aptr->database, "history");

    rc = bcp_init(c_hdbc2, name, NULL, "logs\\history.err", DB_IN);
    if (rc != SUCCEED)
        HandleErrorDBC(c_hdbc2);

    sprintf(bcphint, "tablock");
    rc = bcp_control(c_hdbc2, BCPHINTS, (void*) bcphint);
    if (rc != SUCCEED)
        HandleErrorDBC(c_hdbc2);

    customer_rows_loaded = 0;
    history_rows_loaded = 0;
}
```

Appendix B - Database Design

```
CustomerBufInit();

customer_time_start.time_start = (TimeNow() / MILLI);
history_time_start.time_start = (TimeNow() / MILLI);

for (w_id = (short)aptr->starting_warehouse; w_id <= aptr->num_warehouses;
w_id++)
{
    for (d_id = 1; d_id <= DISTRICT_PER_WAREHOUSE; d_id++)
    {
        CustomerBufLoad(d_id, w_id);

        // Start parallel loading threads here...

        // Start customer table thread

        printf("...Loading customer table for: d_id = %d, w_id =
%d\n", d_id, w_id);

        hThread[0] = CreateThread(NULL,

0,
(LPTHREAD_START_ROUTINE) LoadCustomerTable,
&customer_time_start,
0,
&dwThreadID[0]);

        if (hThread[0] == NULL)
        {
            printf("Error, failed in creating creating thread
= 0.\n");
            exit(-1);
        }

        // Start History table thread

        printf("...Loading history table for: d_id = %d, w_id =
%d\n", d_id, w_id);

        hThread[1] = CreateThread(NULL,

0,
(LPTHREAD_START_ROUTINE) LoadHistoryTable,
&history_time_start,
0,
&dwThreadID[1]);

        if (hThread[1] == NULL)
        {
            printf("Error, failed in creating creating thread
= 1.\n");
            exit(-1);
        }
    }
}
```

```
WaitForSingleObject( hThread[0], INFINITE );
WaitForSingleObject( hThread[1], INFINITE );

if (CloseHandle(hThread[0]) == FALSE)
{
    printf("Error, failed in closing customer thread
handle with errno: %d\n", GetLastError());
}

if (CloseHandle(hThread[1]) == FALSE)
{
    printf("Error, failed in closing history thread
handle with errno: %d\n", GetLastError());
}

}

// flush the bulk connection
rcint = bcp_done(c_hdbc1);
if (rcint < 0)
    HandleErrorDBC(c_hdbc1);

rcint = bcp_done(c_hdbc2);
if (rcint < 0)
    HandleErrorDBC(c_hdbc2);

printf("Finished loading customer table.\n");

// if build index after load...
if ((aptr->build_index == 1) && (aptr->index_order == 0))
    BuildIndex("idxcuscl");

// build non-clustered index
if (aptr->build_index == 1)
    BuildIndex("idxcusnc");

// Output the NURAND used for the loader into C_FIRST for C_ID = 1,
// C_W_ID = 1, and C_D_ID = 1
sprintf(cmd, "isql -S%s -U%s -P%s -d%s -e -Q\"update customer set c_first =
'C_LOAD = %d' where c_id = 1 and c_w_id = 1 and c_d_id = 1\" > logs\\nurand_load.log",
aptr->server,
aptr->user,
aptr->password,
aptr->database,
LOADER_NURAND_C);

system(cmd);

SQLFreeStmt(c_hstmt1, SQL_DROP);
SQLDisconnect(c_hdbc1);
SQLFreeConnect(c_hdbc1);

SQLFreeStmt(c_hstmt2, SQL_DROP);
SQLDisconnect(c_hdbc2);
SQLFreeConnect(c_hdbc2);

return;
}
```

Appendix B - Database Design

```
//=====
//
// Function   : CustomerBufInit
//
//=====
void CustomerBufInit()
{
    int    i;

    for (i=0;i<customers_per_district;i++)
    {
        customer_buf[i].c_id = 0;
        customer_buf[i].c_d_id = 0;
        customer_buf[i].c_w_id = 0;

        strcpy(customer_buf[i].c_first,"");
        strcpy(customer_buf[i].c_middle,"");
        strcpy(customer_buf[i].c_last,"");
        strcpy(customer_buf[i].c_street_1,"");
        strcpy(customer_buf[i].c_street_2,"");
        strcpy(customer_buf[i].c_city,"");
        strcpy(customer_buf[i].c_state,"");
        strcpy(customer_buf[i].c_zip,"");
        strcpy(customer_buf[i].c_phone,"");
        strcpy(customer_buf[i].c_credit,"");

        customer_buf[i].c_credit_lim = 0;
        customer_buf[i].c_discount = (float) 0;

        // fix to avoid ODBC float to numeric conversion problem.
        // customer_buf[i].c_balance = 0;
        strcpy(customer_buf[i].c_balance,"");

        customer_buf[i].c_ytd_payment = 0;
        customer_buf[i].c_payment_cnt = 0;
        customer_buf[i].c_delivery_cnt = 0;

        strcpy(customer_buf[i].c_data,"");

        customer_buf[i].h_amount = 0;

        strcpy(customer_buf[i].h_data,"");

    }
}

//=====
//
// Function   : CustomerBufLoad
//
// Fills shared buffer for HISTORY and CUSTOMER
//=====
void CustomerBufLoad(int d_id, int w_id)
{
    long          i;
    CUSTOMER_SORT_STRUCT  c[CUSTOMERS_PER_DISTRICT];
```

```
for (i=0;i<customers_per_district;i++)
{
    if (i < 1000)
        LastName(i, c[i].c_last);
    else
        LastName(NURand(255,0,999,LOADER_NURAND_C), c[i].c_last);

    MakeAlphaString(8,16,FIRST_NAME_LEN, c[i].c_first);

    c[i].c_id = i+1;
}

printf("...Loading customer buffer for: d_id = %d, w_id = %d\n",
        d_id, w_id);

for (i=0;i<customers_per_district;i++)
{
    customer_buf[i].c_d_id = d_id;
    customer_buf[i].c_w_id = w_id;
    customer_buf[i].h_amount = 10.0;

    customer_buf[i].c_ytd_payment = 10.0;

    customer_buf[i].c_payment_cnt = 1;
    customer_buf[i].c_delivery_cnt = 0;

    // Generate CUSTOMER and HISTORY data

    customer_buf[i].c_id = c[i].c_id;

    strcpy(customer_buf[i].c_first, c[i].c_first);
    strcpy(customer_buf[i].c_last, c[i].c_last);

    customer_buf[i].c_middle[0] = 'O';
    customer_buf[i].c_middle[1] = 'E';

    MakeAddress(customer_buf[i].c_street_1,
                customer_buf[i].c_street_2,
                customer_buf[i].c_city,
                customer_buf[i].c_state,
                customer_buf[i].c_zip);

    MakeNumberString(16, 16, PHONE_LEN, customer_buf[i].c_phone);

    if (RandomNumber(1L, 100L) > 10)
        customer_buf[i].c_credit[0] = 'G';
    else
        customer_buf[i].c_credit[0] = 'B';
    customer_buf[i].c_credit[1] = 'C';

    customer_buf[i].c_credit_lim = 50000.0;
    customer_buf[i].c_discount = ((float) RandomNumber(0L, 5000L)) /
10000.0;

    // fix to avoid ODBC float to numeric conversion problem.
    // customer_buf[i].c_balance = -10.0;
    strcpy(customer_buf[i].c_balance, "-10.0");
```

Appendix B - Database Design

```
        MakeAlphaString(500, 500, C_DATA_LEN, customer_buf[i].c_data);

        // Generate HISTORY data
        MakeAlphaString(12, 24, H_DATA_LEN, customer_buf[i].h_data);
    }
}

//=====
//
// Function   : LoadCustomerTable
//
//=====

void LoadCustomerTable(LOADER_TIME_STRUCT *customer_time_start)
{
    int         i;
    long        c_id;
    short       c_d_id;
    short       c_w_id;
    char        c_first[FIRST_NAME_LEN+1];
    char        c_middle[MIDDLE_NAME_LEN+1];
    char        c_last[LAST_NAME_LEN+1];
    char        c_street_1[ADDRESS_LEN+1];
    char        c_street_2[ADDRESS_LEN+1];
    char        c_city[ADDRESS_LEN+1];
    char        c_state[STATE_LEN+1];
    char        c_zip[ZIP_LEN+1];
    char        c_phone[PHONE_LEN+1];
    char        c_credit[CREDIT_LEN+1];
    double      c_credit_lim;
    double      c_discount;

    // fix to avoid ODBC float to numeric conversion problem.
    // double      c_balance;
    char        c_balance[6];

    double      c_ytd_payment;
    short       c_payment_cnt;
    short       c_delivery_cnt;
    char        c_data[C_DATA_LEN+1];
    char        c_since[C_SINCE_LEN+1];
    RETCODE     rc;

    rc = bcp_bind(c_hdbc1, (BYTE *) &c_id, 0, SQL_VARLEN_DATA, NULL, 0, SQLINT4, 1);
    if (rc != SUCCEEDED)
        HandleErrorDBC(c_hdbc1);

    rc = bcp_bind(c_hdbc1, (BYTE *) &c_d_id, 0, SQL_VARLEN_DATA, NULL, 0, SQLINT2, 2);
    if (rc != SUCCEEDED)
        HandleErrorDBC(c_hdbc1);

    rc = bcp_bind(c_hdbc1, (BYTE *) &c_w_id, 0, SQL_VARLEN_DATA, NULL, 0, SQLINT2,
3);
    if (rc != SUCCEEDED)
        HandleErrorDBC(c_hdbc1);

    rc = bcp_bind(c_hdbc1, (BYTE *) c_first, 0, FIRST_NAME_LEN, NULL, 0, 0, 4);
    if (rc != SUCCEEDED)
        HandleErrorDBC(c_hdbc1);

    rc = bcp_bind(c_hdbc1, (BYTE *) c_middle, 0, MIDDLE_NAME_LEN, NULL, 0, 0, 5);
```

```
    if (rc != SUCCEEDED)
        HandleErrorDBC(c_hdbc1);

    rc = bcp_bind(c_hdbc1, (BYTE *) c_last, 0, LAST_NAME_LEN, NULL, 0, 0, 6);
    if (rc != SUCCEEDED)
        HandleErrorDBC(c_hdbc1);

    rc = bcp_bind(c_hdbc1, (BYTE *) c_street_1, 0, ADDRESS_LEN, NULL, 0, 0, 7);
    if (rc != SUCCEEDED)
        HandleErrorDBC(c_hdbc1);

    rc = bcp_bind(c_hdbc1, (BYTE *) c_street_2, 0, ADDRESS_LEN, NULL, 0, 0, 8);
    if (rc != SUCCEEDED)
        HandleErrorDBC(c_hdbc1);

    rc = bcp_bind(c_hdbc1, (BYTE *) c_city, 0, ADDRESS_LEN, NULL, 0, 0, 9);
    if (rc != SUCCEEDED)
        HandleErrorDBC(c_hdbc1);

    rc = bcp_bind(c_hdbc1, (BYTE *) c_state, 0, STATE_LEN, NULL, 0, 0, 10);
    if (rc != SUCCEEDED)
        HandleErrorDBC(c_hdbc1);

    rc = bcp_bind(c_hdbc1, (BYTE *) c_zip, 0, ZIP_LEN, NULL, 0, 0, 11);
    if (rc != SUCCEEDED)
        HandleErrorDBC(c_hdbc1);

    rc = bcp_bind(c_hdbc1, (BYTE *) c_phone, 0, PHONE_LEN, NULL, 0, 0, 12);
    if (rc != SUCCEEDED)
        HandleErrorDBC(c_hdbc1);

    rc = bcp_bind(c_hdbc1, (BYTE *) &c_since, 0, C_SINCE_LEN, NULL, 0,
SQLCHARACTER, 13);
    if (rc != SUCCEEDED)
        HandleErrorDBC(c_hdbc1);

    rc = bcp_bind(c_hdbc1, (BYTE *) c_credit, 0, CREDIT_LEN, NULL, 0, 0, 14);
    if (rc != SUCCEEDED)
        HandleErrorDBC(c_hdbc1);

    rc = bcp_bind(c_hdbc1, (BYTE *) &c_credit_lim, 0, SQL_VARLEN_DATA, NULL, 0, SQLFLT8,
15);
    if (rc != SUCCEEDED)
        HandleErrorDBC(c_hdbc1);

    rc = bcp_bind(c_hdbc1, (BYTE *) &c_discount, 0, SQL_VARLEN_DATA, NULL, 0, SQLFLT8,
16);
    if (rc != SUCCEEDED)
        HandleErrorDBC(c_hdbc1);

    // fix to avoid ODBC float to numeric conversion problem.
    // rc = bcp_bind(c_hdbc1, (BYTE *) &c_balance, 0, SQL_VARLEN_DATA, NULL, 0, SQLFLT8,
17);
    // if (rc != SUCCEEDED)
    //     HandleErrorDBC(c_hdbc1);
    rc = bcp_bind(c_hdbc1, (BYTE *) c_balance, 0, 5, NULL, 0, SQLCHARACTER, 17);
    if (rc != SUCCEEDED)
        HandleErrorDBC(c_hdbc1);

    rc = bcp_bind(c_hdbc1, (BYTE *) &c_ytd_payment, 0, SQL_VARLEN_DATA, NULL, 0, SQLFLT8,
18);
```

Appendix B - Database Design

```
        if (rc != SUCCEEDED)
            HandleErrorDBC(c_hdbc1);

    rc = bcp_bind(c_hdbc1, (BYTE *) &c_payment_cnt, 0, SQL_VARLEN_DATA, NULL, 0, SQLINT2,
19);
    if (rc != SUCCEEDED)
        HandleErrorDBC(c_hdbc1);

    rc = bcp_bind(c_hdbc1, (BYTE *) &c_delivery_cnt, 0, SQL_VARLEN_DATA, NULL, 0, SQLINT2,
20);
    if (rc != SUCCEEDED)
        HandleErrorDBC(c_hdbc1);

    rc = bcp_bind(c_hdbc1, (BYTE *) c_data, 0, 500, NULL, 0, 0, 21);
    if (rc != SUCCEEDED)
        HandleErrorDBC(c_hdbc1);

    for (i = 0; i < customers_per_district; i++)
    {
        c_id = customer_buf[i].c_id;
        c_d_id = customer_buf[i].c_d_id;
        c_w_id = customer_buf[i].c_w_id;

        strcpy(c_first, customer_buf[i].c_first);
        strcpy(c_middle, customer_buf[i].c_middle);
        strcpy(c_last, customer_buf[i].c_last);
        strcpy(c_street_1, customer_buf[i].c_street_1);
        strcpy(c_street_2, customer_buf[i].c_street_2);
        strcpy(c_city, customer_buf[i].c_city);
        strcpy(c_state, customer_buf[i].c_state);
        strcpy(c_zip, customer_buf[i].c_zip);
        strcpy(c_phone, customer_buf[i].c_phone);
        strcpy(c_credit, customer_buf[i].c_credit);

        FormatDate(&c_since);

        c_credit_lim = customer_buf[i].c_credit_lim;
        c_discount = customer_buf[i].c_discount;

        // fix to avoid ODBC float to numeric conversion problem.

        // c_balance = customer_buf[i].c_balance;
        strcpy(c_balance, customer_buf[i].c_balance);

        c_ytd_payment = customer_buf[i].c_ytd_payment;
        c_payment_cnt = customer_buf[i].c_payment_cnt;
        c_delivery_cnt = customer_buf[i].c_delivery_cnt;

        strcpy(c_data, customer_buf[i].c_data);

        // Send data to server
        rc = bcp_sendrow(c_hdbc1);
        if (rc != SUCCEEDED)
            HandleErrorDBC(c_hdbc1);

        customer_rows_loaded++;
        CheckForCommit(c_hdbc1, c_hstmt1, customer_rows_loaded, "customer");
&customer_time_start->time_start);
    }
}
```

```
=====
//
// Function : LoadHistoryTable
//
//=====

void LoadHistoryTable(LOADER_TIME_STRUCT *history_time_start)
{
    int i;

    long c_id;
    short c_d_id;
    short c_w_id;
    double h_amount;
    char h_data[H_DATA_LEN+1];
    char h_date[H_DATE_LEN+1];
    RETCODE rc;

    rc = bcp_bind(c_hdbc2, (BYTE *) &c_id, 0, SQL_VARLEN_DATA, NULL, 0, SQLINT4, 1);
    if (rc != SUCCEEDED)
        HandleErrorDBC(c_hdbc2);

    rc = bcp_bind(c_hdbc2, (BYTE *) &c_d_id, 0, SQL_VARLEN_DATA, NULL, 0, SQLINT2, 2);
    if (rc != SUCCEEDED)
        HandleErrorDBC(c_hdbc2);

    rc = bcp_bind(c_hdbc2, (BYTE *) &c_w_id, 0, SQL_VARLEN_DATA, NULL, 0, SQLINT2, 3);
    if (rc != SUCCEEDED)
        HandleErrorDBC(c_hdbc2);

    rc = bcp_bind(c_hdbc2, (BYTE *) &c_d_id, 0, SQL_VARLEN_DATA, NULL, 0, SQLINT2, 4);
    if (rc != SUCCEEDED)
        HandleErrorDBC(c_hdbc2);

    rc = bcp_bind(c_hdbc2, (BYTE *) &c_w_id, 0, SQL_VARLEN_DATA, NULL, 0, SQLINT2, 5);
    if (rc != SUCCEEDED)
        HandleErrorDBC(c_hdbc2);

    rc = bcp_bind(c_hdbc2, (BYTE *) &h_date, 0, H_DATE_LEN, NULL, 0, SQLCHARACTER,
6);
    if (rc != SUCCEEDED)
        HandleErrorDBC(c_hdbc2);

    rc = bcp_bind(c_hdbc2, (BYTE *) &h_amount, 0, SQL_VARLEN_DATA, NULL, 0, SQLFLT8, 7);
    if (rc != SUCCEEDED)
        HandleErrorDBC(c_hdbc2);

    rc = bcp_bind(c_hdbc2, (BYTE *) h_data, 0, H_DATA_LEN, NULL, 0, 8);
    if (rc != SUCCEEDED)
        HandleErrorDBC(c_hdbc2);

    for (i = 0; i < customers_per_district; i++)
    {
        c_id = customer_buf[i].c_id;
        c_d_id = customer_buf[i].c_d_id;
        c_w_id = customer_buf[i].c_w_id;
        h_amount = customer_buf[i].h_amount;
        strcpy(h_data, customer_buf[i].h_data);

        FormatDate(&h_date);

        // send to server
        rc = bcp_sendrow(c_hdbc2);
        if (rc != SUCCEEDED)
            HandleErrorDBC(c_hdbc2);
    }
}
```

Appendix B - Database Design

```
        HandleErrorDBC(o_hdbc2);

        history_rows_loaded++;
        CheckForCommit(c_hdbc2, c_hstmt2, history_rows_loaded, "history",
&history_time_start->time_start);
    }
}

//=====
//
// Function   : LoadOrders
//
//=====

void LoadOrders()
{
    LOADER_TIME_STRUCT    orders_time_start;
    LOADER_TIME_STRUCT    new_order_time_start;
    LOADER_TIME_STRUCT    order_line_time_start;
    short                 w_id;

    short                 d_id;

    DWORD                 dwThreadID[MAX_ORDER_THREADS];
    HANDLE                 hThread[MAX_ORDER_THREADS];
    char                   name[20];

    RETCODE                rc;
    char                   bcphint[128];

    // seed with unique number
    seed(6);

    printf("Loading orders...\n");

    // if build index before load...
    if ((aptr->build_index == 1) && (aptr->index_order == 1))
    {
        BuildIndex("idxordcl");
        BuildIndex("idxnodcl");
        BuildIndex("idxodlcl");
    }

    // initialize bulk copy
    sprintf(name, "%s.%s", aptr->database, "orders");

    rc = bcp_init(o_hdbc1, name, NULL, "logs\\orders.err", DB_IN);
    if (rc != SUCCEEDED)
        HandleErrorDBC(o_hdbc1);

    if ((aptr->build_index == 1) && (aptr->index_order == 1))
    {
        sprintf(bcphint, "tablock, order (o_w_id, o_d_id, o_id),
ROWS_PER_BATCH = %u", (aptr->num_warehouses * 30000));
        rc = bcp_control(o_hdbc1, BCPHINTS, (void*) bcphint);
        if (rc != SUCCEEDED)
            HandleErrorDBC(o_hdbc1);
    }

    sprintf(name, "%s.%s", aptr->database, "new_order");

    rc = bcp_init(o_hdbc2, name, NULL, "logs\\neword.err", DB_IN);
    if (rc != SUCCEEDED)
        HandleErrorDBC(o_hdbc2);
```

```
        if ((aptr->build_index == 1) && (aptr->index_order == 1))
        {
            sprintf(bcphint, "tablock, order (no_w_id, no_d_id, no_o_id),
ROWS_PER_BATCH = %u", (aptr->num_warehouses * 9000));
            rc = bcp_control(o_hdbc2, BCPHINTS, (void*) bcphint);
            if (rc != SUCCEEDED)
                HandleErrorDBC(o_hdbc2);
        }

        sprintf(name, "%s.%s", aptr->database, "order_line");

        rc = bcp_init(o_hdbc3, name, NULL, "logs\\ordline.err", DB_IN);
        if (rc != SUCCEEDED)
            HandleErrorDBC(o_hdbc3);

        if ((aptr->build_index == 1) && (aptr->index_order == 1))
        {
            sprintf(bcphint, "tablock, order (ol_w_id, ol_d_id, ol_o_id,
ol_number), ROWS_PER_BATCH = %u", (aptr->num_warehouses * 30000));
            rc = bcp_control(o_hdbc3, BCPHINTS, (void*) bcphint);
            if (rc != SUCCEEDED)
                HandleErrorDBC(o_hdbc3);
        }

        orders_rows_loaded = 0;
        new_order_rows_loaded = 0;
        order_line_rows_loaded = 0;

        OrdersBufInit();

        orders_time_start.time_start = (TimeNow() / MILLI);
        new_order_time_start.time_start = (TimeNow() / MILLI);
        order_line_time_start.time_start = (TimeNow() / MILLI);

        for (w_id = (short)aptr->starting_warehouse; w_id <= aptr->num_warehouses;
w_id++)
        {
            for (d_id = 1; d_id <= DISTRICT_PER_WAREHOUSE; d_id++)
            {
                OrdersBufLoad(d_id, w_id);

                // start parallel loading threads here...

                // start Orders table thread
                printf("...Loading Order Table for: d_id = %d, w_id =
%d\n", d_id, w_id);

                hThread[0] = CreateThread(NULL,

0,

(LPTHREAD_START_ROUTINE) LoadOrdersTable,

&orders_time_start,

0,

&dwThreadID[0]);

                if (hThread[0] == NULL)
```

Appendix B - Database Design

```
    {
        printf("Error, failed in creating creating thread
= 0.\n");
        exit(-1);
    }
    // start NewOrder table thread
    printf("...Loading New-Order Table for: d_id = %d, w_id =
%d\n", d_id, w_id);
    hThread[1] = CreateThread(NULL,
0,
(LPTHREAD_START_ROUTINE) LoadNewOrderTable,
&new_order_time_start,
0,
&dwThreadID[1]);
    if (hThread[1] == NULL)
    {
        printf("Error, failed in creating creating thread
= 1.\n");
        exit(-1);
    }
    // start Order-Line table thread
    printf("...Loading Order-Line Table for: d_id = %d, w_id =
%d\n", d_id, w_id);
    hThread[2] = CreateThread(NULL,
0,
(LPTHREAD_START_ROUTINE) LoadOrderLineTable,
&order_line_time_start,
0,
&dwThreadID[2]);
    if (hThread[2] == NULL)
    {
        printf("Error, failed in creating creating thread
= 2.\n");
        exit(-1);
    }
    WaitForSingleObject( hThread[0], INFINITE );
    WaitForSingleObject( hThread[1], INFINITE );
    WaitForSingleObject( hThread[2], INFINITE );
    if (CloseHandle(hThread[0]) == FALSE)
    {
        printf("Error, failed in closing Orders thread
handle with errno: %d\n", GetLastError());
    }
}
```

```
        if (CloseHandle(hThread[1]) == FALSE)
        {
            printf("Error, failed in closing NewOrder thread
handle with errno: %d\n", GetLastError());
        }
        if (CloseHandle(hThread[2]) == FALSE)
        {
            printf("Error, failed in closing OrderLine thread
handle with errno: %d\n", GetLastError());
        }
    }
    printf("Finished loading orders.\n");
return;
}
//=====
//
// Function : OrdersBufInit
// Clears shared buffer for ORDERS, NEWORDER, and ORDERLINE
//
//=====
void OrdersBufInit()
{
    int i;
    int j;
    for (i=0;i<orders_per_district;i++)
    {
        orders_buf[i].o_id = 0;
        orders_buf[i].o_d_id = 0;
        orders_buf[i].o_w_id = 0;
        orders_buf[i].o_c_id = 0;
        orders_buf[i].o_carrier_id = 0;
        orders_buf[i].o_ol_cnt = 0;
        orders_buf[i].o_all_local = 0;
        for (j=0;j<=14;j++)
        {
            orders_buf[i].o_ol[j].ol = 0;
            orders_buf[i].o_ol[j].ol_i_id = 0;
            orders_buf[i].o_ol[j].ol_supply_w_id = 0;
            orders_buf[i].o_ol[j].ol_quantity = 0;
            orders_buf[i].o_ol[j].ol_amount = 0;
            strcpy(orders_buf[i].o_ol[j].ol_dist_info,"");
        }
    }
}
//=====
//
```

Appendix B - Database Design

```
// Function : OrdersBufLoad
//
// Fills shared buffer for ORDERS, NEWORDER, and ORDERLINE
//
//=====
void OrdersBufLoad(int d_id, int w_id)
{
    int    cust[ORDERS_PER_DIST+1];
    long   o_id;
    short  ol;

    printf("...Loading Order Buffer for: d_id = %d, w_id = %d\n",
           d_id, w_id);

    GetPermutation(cust, ORDERS_PER_DIST);

    for (o_id=0;o_id<orders_per_district;o_id++)
    {
        // Generate ORDER and NEW-ORDER data

        orders_buf[o_id].o_d_id = d_id;
        orders_buf[o_id].o_w_id = w_id;
        orders_buf[o_id].o_id = o_id+1;
        orders_buf[o_id].o_c_id = cust[o_id+1];
        orders_buf[o_id].o_ol_cnt = (short)RandomNumber(5L, 15L);

        if (o_id < first_new_order)
        {
            orders_buf[o_id].o_carrier_id = (short)RandomNumber(1L,
10L);
            orders_buf[o_id].o_all_local = 1;
        }
        else
        {
            orders_buf[o_id].o_carrier_id = 0;
            orders_buf[o_id].o_all_local = 1;
        }

        for (ol=0; ol<orders_buf[o_id].o_ol_cnt; ol++)
        {
            orders_buf[o_id].o_ol[ol].ol = ol+1;
            orders_buf[o_id].o_ol[ol].ol_i_id = RandomNumber(1L,
max_items);
            orders_buf[o_id].o_ol[ol].ol_supply_w_id = w_id;
            orders_buf[o_id].o_ol[ol].ol_quantity = 5;
            MakeAlphaString(24, 24, OL_DIST_INFO_LEN,
&orders_buf[o_id].o_ol[ol].ol_dist_info);

            // Generate ORDER-LINE data
            if (o_id < first_new_order)
            {
                orders_buf[o_id].o_ol[ol].ol_amount = 0;
                // Added to insure ol_delivery_d set properly

                during load

                FormatDate(&orders_buf[o_id].o_ol[ol].ol_delivery_d);
            }
        }
    }
}
```

```
        else
        {
            orders_buf[o_id].o_ol[ol].ol_amount =
RandomNumber(1,999999)/100.0;
            // Added to insure ol_delivery_d set properly

            during load

            // odbc datetime format

            strcpy(orders_buf[o_id].o_ol[ol].ol_delivery_d,"1899-12-31 12:00:00.000");
        }
    }
}

//=====
//
// Function : LoadOrdersTable
//
//=====
void LoadOrdersTable(LOADER_TIME_STRUCT *orders_time_start)
{
    int    i;
    long   o_id;
    short  o_d_id;
    short  o_w_id;
    long   o_c_id;
    short  o_carrier_id;
    short  o_ol_cnt;
    short  o_all_local;
    char   o_entry_d[O_ENTRY_D_LEN+1];
    RETCODE rc;
    DBINT   rcint;

    // bind ORDER data
    rc = bcp_bind(o_hdbc1, (BYTE *) &o_id, 0, SQL_VARLEN_DATA, NULL, 0, SQLINT4, 1);
    if (rc != SUCCEED)
        HandleErrorDBC(o_hdbc1);

    rc = bcp_bind(o_hdbc1, (BYTE *) &o_d_id, 0, SQL_VARLEN_DATA, NULL, 0, SQLINT2, 2);
    if (rc != SUCCEED)
        HandleErrorDBC(o_hdbc1);

    rc = bcp_bind(o_hdbc1, (BYTE *) &o_w_id, 0, SQL_VARLEN_DATA, NULL, 0, SQLINT2, 3);
    if (rc != SUCCEED)
        HandleErrorDBC(o_hdbc1);

    rc = bcp_bind(o_hdbc1, (BYTE *) &o_c_id, 0, SQL_VARLEN_DATA, NULL, 0, SQLINT4, 4);
    if (rc != SUCCEED)
        HandleErrorDBC(o_hdbc1);

    rc = bcp_bind(o_hdbc1, (BYTE *) &o_entry_d, 0, O_ENTRY_D_LEN, NULL, 0,
SQLCHARACTER, 5);
    if (rc != SUCCEED)
        HandleErrorDBC(o_hdbc1);

    rc = bcp_bind(o_hdbc1, (BYTE *) &o_carrier_id, 0, SQL_VARLEN_DATA, NULL, 0, SQLINT2,
6);
    if (rc != SUCCEED)
        HandleErrorDBC(o_hdbc1);
}
```

Appendix B - Database Design

```
rc = bcp_bind(o_hdbc1, (BYTE *) &o_ol_cnt, 0, SQL_VARLEN_DATA, NULL, 0, SQLINT2, 7);
if (rc != SUCCEED)
    HandleErrorDBC(o_hdbc1);

rc = bcp_bind(o_hdbc1, (BYTE *) &o_all_local, 0, SQL_VARLEN_DATA, NULL, 0, SQLINT2,
8);
if (rc != SUCCEED)
    HandleErrorDBC(o_hdbc1);

for (i = 0; i < orders_per_district; i++)
{
    o_id      = orders_buf[i].o_id;
    o_d_id    = orders_buf[i].o_d_id;
    o_w_id    = orders_buf[i].o_w_id;
    o_c_id    = orders_buf[i].o_c_id;
    o_carrier_id = orders_buf[i].o_carrier_id;
    o_ol_cnt  = orders_buf[i].o_ol_cnt;
    o_all_local = orders_buf[i].o_all_local;

    FormatDate(&o_entry_d);

    // send data to server
    rc = bcp_sendrow(o_hdbc1);
    if (rc != SUCCEED)
        HandleErrorDBC(o_hdbc1);

    orders_rows_loaded++;
    CheckForCommit(o_hdbc1, o_hstmt1, orders_rows_loaded, "orders",
&orders_time_start->time_start);
}

// rcint = bcp_batch(o_hdbc1);
// if (rcint < 0)
//     HandleErrorDBC(o_hdbc1);

if ((o_w_id == aptr->num_warehouses) && (o_d_id == 10))
{
    rcint = bcp_done(o_hdbc1);
    if (rcint < 0)
        HandleErrorDBC(o_hdbc1);

    SQLFreeStmt(o_hstmt1, SQL_DROP);
    SQLDisconnect(o_hdbc1);
    SQLFreeConnect(o_hdbc1);

    // if build index after load...
    if ((aptr->build_index == 1) && (aptr->index_order == 0))
        BuildIndex("idxordcl");

    // build non-clustered index
    if (aptr->build_index == 1)
        BuildIndex("idxordnc");
}

}

//=====
//
// Function   : LoadNewOrderTable
//
//=====
```

```
void LoadNewOrderTable(LOADER_TIME_STRUCT *new_order_time_start)
{
    int      i;
    long     o_id;
    short    o_d_id;
    short    o_w_id;

    RETCODE  rc;
    DBINT    rcint;

    // Bind NEW-ORDER data

    rc = bcp_bind(o_hdbc2, (BYTE *) &o_id, 0, SQL_VARLEN_DATA, NULL, 0, SQLINT4, 1);
    if (rc != SUCCEED)
        HandleErrorDBC(o_hdbc2);

    rc = bcp_bind(o_hdbc2, (BYTE *) &o_d_id, 0, SQL_VARLEN_DATA, NULL, 0, SQLINT2, 2);
    if (rc != SUCCEED)
        HandleErrorDBC(o_hdbc2);

    rc = bcp_bind(o_hdbc2, (BYTE *) &o_w_id, 0, SQL_VARLEN_DATA, NULL, 0, SQLINT2, 3);
    if (rc != SUCCEED)
        HandleErrorDBC(o_hdbc2);

    for (i = first_new_order; i < last_new_order; i++)
    {
        o_id  = orders_buf[i].o_id;
        o_d_id = orders_buf[i].o_d_id;
        o_w_id = orders_buf[i].o_w_id;

        rc = bcp_sendrow(o_hdbc2);
        if (rc != SUCCEED)
            HandleErrorDBC(o_hdbc2);

        new_order_rows_loaded++;
        CheckForCommit(o_hdbc2, o_hstmt2, new_order_rows_loaded, "new_order",
&new_order_time_start->time_start);
    }

    // rcint = bcp_batch(o_hdbc2);
    // if (rcint < 0)
    //     HandleErrorDBC(o_hdbc2);

    if ((o_w_id == aptr->num_warehouses) && (o_d_id == 10))
    {
        rcint = bcp_done(o_hdbc2);
        if (rcint < 0)
            HandleErrorDBC(o_hdbc2);

        SQLFreeStmt(o_hstmt2, SQL_DROP);
        SQLDisconnect(o_hdbc2);
        SQLFreeConnect(o_hdbc2);

        // if build index after load...
        if ((aptr->build_index == 1) && (aptr->index_order == 0))
            BuildIndex("idxmodcl");
    }

}

//=====
```

Appendix B - Database Design

```
//
// Function : LoadOrderLineTable
//
//=====
void LoadOrderLineTable(LOADER_TIME_STRUCT *order_line_time_start)
{
    int i,j;
    long o_id;
    short o_d_id;
    short o_w_id;
    long ol;
    long ol_i_id;
    short ol_supply_w_id;
    short ol_quantity;
    double ol_amount;
    char ol_dist_info[DIST_INFO_LEN+1];
    char ol_delivery_d[OL_DELIVERY_D_LEN+1];
    RETCODE rc;
    DBINT rcint;

    // bind ORDER-LINE data
    rc = bcp_bind(o_hdbc3, (BYTE *) &o_id, 0, SQL_VARLEN_DATA, NULL, 0, SQLINT4, 1);
    if (rc != SUCCEEDED)
        HandleErrorDBC(o_hdbc3);

    rc = bcp_bind(o_hdbc3, (BYTE *) &o_d_id, 0, SQL_VARLEN_DATA, NULL, 0, SQLINT2, 2);
    if (rc != SUCCEEDED)
        HandleErrorDBC(o_hdbc3);

    rc = bcp_bind(o_hdbc3, (BYTE *) &o_w_id, 0, SQL_VARLEN_DATA, NULL, 0, SQLINT2, 3);
    if (rc != SUCCEEDED)
        HandleErrorDBC(o_hdbc3);

    rc = bcp_bind(o_hdbc3, (BYTE *) &ol, 0, SQL_VARLEN_DATA, NULL, 0, SQLINT4, 4);
    if (rc != SUCCEEDED)
        HandleErrorDBC(o_hdbc3);

    rc = bcp_bind(o_hdbc3, (BYTE *) &ol_i_id, 0, SQL_VARLEN_DATA, NULL, 0, SQLINT4, 5);
    if (rc != SUCCEEDED)
        HandleErrorDBC(o_hdbc3);

    rc = bcp_bind(o_hdbc3, (BYTE *) &ol_supply_w_id, 0, SQL_VARLEN_DATA, NULL, 0,
SQLINT2, 6);
    if (rc != SUCCEEDED)
        HandleErrorDBC(o_hdbc3);

    rc = bcp_bind(o_hdbc3, (BYTE *) &ol_delivery_d, 0, OL_DELIVERY_D_LEN, NULL, 0,
SQLCHARACTER, 7);
    if (rc != SUCCEEDED)
        HandleErrorDBC(o_hdbc3);

    rc = bcp_bind(o_hdbc3, (BYTE *) &ol_quantity, 0, SQL_VARLEN_DATA, NULL, 0, SQLINT2,
8);
    if (rc != SUCCEEDED)
        HandleErrorDBC(o_hdbc3);

    rc = bcp_bind(o_hdbc3, (BYTE *) &ol_amount, 0, SQL_VARLEN_DATA, NULL, 0, SQLFLT8, 9);
    if (rc != SUCCEEDED)
        HandleErrorDBC(o_hdbc3);

    rc = bcp_bind(o_hdbc3, (BYTE *) ol_dist_info, 0, DIST_INFO_LEN, NULL, 0, 0, 10);
    if (rc != SUCCEEDED)
```

```
        HandleErrorDBC(o_hdbc3);

    for (i = 0; i < orders_per_district; i++)
    {
        o_id = orders_buf[i].o_id;
        o_d_id = orders_buf[i].o_d_id;
        o_w_id = orders_buf[i].o_w_id;

        for (j=0; j < orders_buf[i].o_ol_cnt; j++)
        {
            ol = orders_buf[i].o_ol[j].ol;
            ol_i_id = orders_buf[i].o_ol[j].ol_i_id;
            ol_supply_w_id = orders_buf[i].o_ol[j].ol_supply_w_id;
            ol_quantity = orders_buf[i].o_ol[j].ol_quantity;
            ol_amount = orders_buf[i].o_ol[j].ol_amount;

            strcpy(ol_delivery_d,orders_buf[i].o_ol[j].ol_delivery_d);

            strcpy(ol_dist_info,orders_buf[i].o_ol[j].ol_dist_info);

            rc = bcp_sendrow(o_hdbc3);
            if (rc != SUCCEEDED)
                HandleErrorDBC(o_hdbc3);

            order_line_rows_loaded++;
            CheckForCommit(o_hdbc3, o_hstmt3, order_line_rows_loaded,
"order_line", &order_line_time_start->time_start);
        }
    }

    // rcint = bcp_batch(o_hdbc3);
    // if (rcint < 0)
    //     HandleErrorDBC(o_hdbc3);

    if ((o_w_id == aptr->num_warehouses) && (o_d_id == 10))
    {
        rcint = bcp_done(o_hdbc3);
        if (rcint < 0)
            HandleErrorDBC(o_hdbc3);

        SQLFreeStmt(o_hstmt3, SQL_DROP);
        SQLDisconnect(o_hdbc3);
        SQLFreeConnect(o_hdbc3);

        // if build index after load...
        if ((aptr->build_index == 1) && (aptr->index_order == 0))
            BuildIndex("idxodlcl");
    }
}

//=====
//
// Function : GetPermutation
//
//=====
void GetPermutation(int perm[], int n)
{
    int i, r, t;
```

Appendix B - Database Design

```
for (i=1;i<=n;i++)
    perm[i] = i;

for (i=1;i<=n;i++)
{
    r = RandomNumber(i,n);
    t = perm[i];
    perm[i] = perm[r];
    perm[r] = t;
}

//=====
//
// Function   : CheckForCommit
//
//=====

void CheckForCommit(HDBC hdbc,
                   HSTMT hstmt,
                   int rows_loaded,
                   char *table_name,
                   long *time_start)
{
    long time_end, time_diff;
    // DBINT rcint;

    if ( !(rows_loaded % aptr->batch) )
    {
        // rcint = bcp_batch(hdbc);
        // if (rcint < 0)
        //     HandleErrorDBC(hdbc);

        time_end = (TimeNow() / MILLI);
        time_diff = time_end - *time_start;

        printf("-> Loaded %ld rows into %s in %ld sec - Total = %d (%.2f
rps)\n",
               aptr->batch,
               table_name,
               time_diff,
               rows_loaded,
               (float) aptr->batch / (time_diff ? time_diff :
1L));

        *time_start = time_end;
    }

    return;
}

//=====
//
// Function   : OpenConnections
//
//=====
```

```
void OpenConnections()
{
    RETCODE rc;

    char szDriverString[300];
    char szDriverStringOut[1024];
    SQLSMALLINT cbDriverStringOut;

    SQLAllocHandle(SQL_HANDLE_ENV, SQL_NULL_HANDLE, &henv );
    SQLSetEnvAttr(henv, SQL_ATTR_ODBC_VERSION, (void*)SQL_OV_ODBC3, 0 );

    SQLAllocHandle(SQL_HANDLE_DBC, henv , &i_hdbc1);
    SQLAllocHandle(SQL_HANDLE_DBC, henv , &w_hdbc1);
    SQLAllocHandle(SQL_HANDLE_DBC, henv , &c_hdbc1);
    SQLAllocHandle(SQL_HANDLE_DBC, henv , &c_hdbc2);
    SQLAllocHandle(SQL_HANDLE_DBC, henv , &o_hdbc1);
    SQLAllocHandle(SQL_HANDLE_DBC, henv , &o_hdbc2);
    SQLAllocHandle(SQL_HANDLE_DBC, henv , &o_hdbc3);

    SQLSetConnectAttr(i_hdbc1, SQL_COPT_SS_BCP, (void *)SQL_BCP_ON, SQL_IS_INTEGER
);
    SQLSetConnectAttr(w_hdbc1, SQL_COPT_SS_BCP, (void *)SQL_BCP_ON, SQL_IS_INTEGER
);
    SQLSetConnectAttr(c_hdbc1, SQL_COPT_SS_BCP, (void *)SQL_BCP_ON, SQL_IS_INTEGER
);
    SQLSetConnectAttr(c_hdbc2, SQL_COPT_SS_BCP, (void *)SQL_BCP_ON, SQL_IS_INTEGER
);
    SQLSetConnectAttr(o_hdbc1, SQL_COPT_SS_BCP, (void *)SQL_BCP_ON, SQL_IS_INTEGER
);
    SQLSetConnectAttr(o_hdbc2, SQL_COPT_SS_BCP, (void *)SQL_BCP_ON, SQL_IS_INTEGER
);
    SQLSetConnectAttr(o_hdbc3, SQL_COPT_SS_BCP, (void *)SQL_BCP_ON, SQL_IS_INTEGER
);

    // Open connections to SQL Server
    // Connection 1

    sprintf( szDriverString , "DRIVER={SQL
Server};SERVER=%s;UID=%s;PWD=%s;DATABASE=%s" ,
            aptr->server,
            aptr->user,
            aptr->password,
            aptr->database );

    rc = SQLSetConnectOption (i_hdbc1, SQL_PACKET_SIZE, aptr->pack_size);
    if (rc != SUCCEED)
        HandleErrorDBC(i_hdbc1);

    rc = SQLDriverConnect ( i_hdbc1,
                           NULL,
                           (SQLCHAR*)&szDriverString[0],
                           SQL_NTS,
                           (SQLCHAR*)&szDriverStringOut[0],
                           sizeof(szDriverStringOut),
                           &cbDriverStringOut,
                           SQL_DRIVER_NOPROMPT );

    if (rc != SUCCEED)
```

Appendix B - Database Design

```
        HandleErrorDBC(i_hdbc1);

// Connection 2

sprintf( szDriverString , "DRIVER={SQL
Server};SERVER=%s;UID=%s;PWD=%s;DATABASE=%s" ,

aptr->server,
aptr->user,
aptr->password,
aptr->database );

rc = SQLSetConnectOption (w_hdbc1, SQL_PACKET_SIZE, aptr->pack_size);
if (rc != SUCCEED)
    HandleErrorDBC(w_hdbc1);

rc = SQLDriverConnect ( w_hdbc1,

NULL,

(SQLCHAR*)&szDriverString[0] ,

SQL_NTS,

(SQLCHAR*)&szDriverStringOut[0],

sizeof(szDriverStringOut),

&cbDriverStringOut,
SQL_DRIVER_NOPROMPT

);

if (rc != SUCCEED)
    HandleErrorDBC(w_hdbc1);

// Connection 3

sprintf( szDriverString , "DRIVER={SQL
Server};SERVER=%s;UID=%s;PWD=%s;DATABASE=%s" ,

aptr->server,
aptr->user,
aptr->password,
aptr->database );

rc = SQLSetConnectOption (c_hdbc1, SQL_PACKET_SIZE, aptr->pack_size);
if (rc != SUCCEED)
    HandleErrorDBC(c_hdbc1);

rc = SQLDriverConnect ( c_hdbc1,

NULL,

(SQLCHAR*)&szDriverString[0] ,

SQL_NTS,

(SQLCHAR*)&szDriverStringOut[0],

sizeof(szDriverStringOut),

&cbDriverStringOut,
SQL_DRIVER_NOPROMPT

);

if (rc != SUCCEED)
    HandleErrorDBC(c_hdbc1);

// Connection 4

sprintf( szDriverString , "DRIVER={SQL
Server};SERVER=%s;UID=%s;PWD=%s;DATABASE=%s" ,

aptr->server,

aptr->user,
aptr->password,
aptr->database );

rc = SQLSetConnectOption (c_hdbc2, SQL_PACKET_SIZE, aptr->pack_size);
if (rc != SUCCEED)
    HandleErrorDBC(c_hdbc2);

rc = SQLDriverConnect ( c_hdbc2,

NULL,

(SQLCHAR*)&szDriverString[0] ,

SQL_NTS,

(SQLCHAR*)&szDriverStringOut[0],

sizeof(szDriverStringOut),

&cbDriverStringOut,
SQL_DRIVER_NOPROMPT

);

if (rc != SUCCEED)
    HandleErrorDBC(c_hdbc2);

// Connection 5

sprintf( szDriverString , "DRIVER={SQL
Server};SERVER=%s;UID=%s;PWD=%s;DATABASE=%s" ,

aptr->server,
aptr->user,
aptr->password,
aptr->database );

rc = SQLSetConnectOption (o_hdbc1, SQL_PACKET_SIZE, aptr->pack_size);
if (rc != SUCCEED)
    HandleErrorDBC(o_hdbc1);

rc = SQLDriverConnect ( o_hdbc1,

NULL,

(SQLCHAR*)&szDriverString[0] ,

SQL_NTS,

(SQLCHAR*)&szDriverStringOut[0],

sizeof(szDriverStringOut),

&cbDriverStringOut,
SQL_DRIVER_NOPROMPT

);

if (rc != SUCCEED)
    HandleErrorDBC(o_hdbc1);

// Connection 6

sprintf( szDriverString , "DRIVER={SQL
Server};SERVER=%s;UID=%s;PWD=%s;DATABASE=%s" ,

aptr->server,
aptr->user,
aptr->password,
aptr->database );

rc = SQLSetConnectOption (o_hdbc2, SQL_PACKET_SIZE, aptr->pack_size);
if (rc != SUCCEED)
    HandleErrorDBC(o_hdbc2);
```

Appendix B - Database Design

```
rc = SQLDriverConnect ( o_hdbc2,
                        NULL,
                        (SQLCHAR*)&szDriverString[0] ,
                        SQL_NTS,
                        (SQLCHAR*)&szDriverStringOut[0],
                        sizeof(szDriverStringOut),
                        &cbDriverStringOut,
                        SQL_DRIVER_NOPROMPT
);
if (rc != SUCCEED)
    HandleErrorDBC(o_hdbc2);

// Connection 7

sprintf( szDriverString , "DRIVER={SQL
Server};SERVER=%s;UID=%s;PWD=%s;DATABASE=%s" ,
        aptr->server,
        aptr->user,
        aptr->password,
        aptr->database );

rc = SQLSetConnectOption (o_hdbc3, SQL_PACKET_SIZE, aptr->pack_size);
if (rc != SUCCEED)
    HandleErrorDBC(o_hdbc3);

rc = SQLDriverConnect ( o_hdbc3,
                        NULL,
                        (SQLCHAR*)&szDriverString[0] ,
                        SQL_NTS,
                        (SQLCHAR*)&szDriverStringOut[0],
                        sizeof(szDriverStringOut),
                        &cbDriverStringOut,
                        SQL_DRIVER_NOPROMPT
);
if (rc != SUCCEED)
    HandleErrorDBC(o_hdbc3);
}

//=====
//
// Function name: BuildIndex
//
//=====

void BuildIndex(char        *index_script)
{
    char    cmd[256];

    printf("Starting index creation:  %s\n",index_script);

    sprintf(cmd, "isql -S%s -U%s -P%s -e -i%s\\%s.sql > logs\\%s.log",
            aptr->server,
            aptr->user,
            aptr->password,
            aptr->index_script_path,
            index_script,
            index_script);

    system(cmd);

    printf("Finished index creation:  %s\n",index_script);
}

void HandleErrorDBC (SQLHDBC  hdbc1)
{
    SQLCHAR        SqlState[6], Msg[SQL_MAX_MESSAGE_LENGTH];
    SQLINTEGER     NativeError;
    SQLSMALLINT    i, MsgLen;
    SQLRETURN      rc2;
    char           timebuf[128];
    char           datebuf[128];
    FILE           *fp1;

    i = 1;
    while (( rc2 = SQLGetDiagRec(SQL_HANDLE_DBC , hdbc1, i, SqlState ,
    &NativeError,
                                Msg, sizeof(Msg) , &MsgLen )) != SQL_NO_DATA )
    {
        sprintf( szLastError , "%s" , Msg );

        _strtime(timebuf);
        _strdate(datebuf);

        printf( "[%s : %s] %s\n" , datebuf, timebuf, szLastError);

        fp1 = fopen("logs\\tpccldr.err","w");
        if (fp1 == NULL)
            printf("ERROR:  Unable to open errorlog file.\n");
        else
        {
            fprintf(fp1, "[%s : %s] %s\n" , datebuf, timebuf,
            szLastError);

            fclose(fp1);
        }

        i++;
    }
}

void FormatDate ( char* szTimeCOutput )
{
    struct tm when;
    time_t now;

    time( &now );
    when = *localtime( &now );

    mktime( &when );

    // odbc datetime format
    strftime( szTimeCOutput , 30 , "%Y-%m-%d %H:%M:%S.000", &when );
}
```

Appendix B - Database Design

```
        return;
    }
}
```

getargs.c

```
//      File:          GETARGS.C
//
//      Microsoft TPC-C Kit Ver. 4.00
//      Copyright Microsoft, 1996, 1997, 1998
//      Purpose:  Source file for command line processing

// Includes
#include "tpcc.h"

//=====
//
// Function name: GetArgsLoader
//
//=====

void GetArgsLoader(int argc, char **argv, TPCCLDR_ARGS *pargs)
{
    int    i;
    char  *ptr;

#ifdef DEBUG
    printf("[%ld]DBG: Entering GetArgsLoader()\n", (int) GetCurrentThreadId());
#endif

    /* init args struct with some useful values */
    pargs->server      = SERVER;
    pargs->user        = USER;
    pargs->password    = PASSWORD;
    pargs->database    = DATABASE;
    pargs->batch       = BATCH;
    pargs->num_warehouses = UNDEF;
    pargs->tables_all  = TRUE;
    pargs->table_item  = FALSE;
    pargs->table_warehouse = FALSE;
    pargs->table_customer = FALSE;
}
```

```
    pargs->table_orders      = FALSE;
    pargs->loader_res_file   = LOADER_RES_FILE;
    pargs->pack_size         = DEF_LD_PACKSIZE;
    pargs->starting_warehouse = DEF_STARTING_WAREHOUSE;
    pargs->build_index       = BUILD_INDEX;
    pargs->index_order       = INDEX_ORDER;
    pargs->index_script_path = INDEX_SCRIPT_PATH;
    pargs->scale_down        = SCALE_DOWN;

/* check for zero command line args */
if ( argc == 1 )
    GetArgsLoaderUsage();

for ( i = 1; i < argc; ++i )
{
    if ( argv[i][0] != '-' && argv[i][0] != '/' )
    {
        printf("\nUnrecognized command");
        GetArgsLoaderUsage();
        exit(1);
    }

    ptr = argv[i];

    switch ( ptr[1] )
    {
        case 'h': /* Fall through */
        case 'H':
            GetArgsLoaderUsage();
            break;

        case 'D':
            pargs->database = ptr+2;
            break;

        case 'P':
            pargs->password = ptr+2;
            break;

        case 'S':
            pargs->server = ptr+2;
            break;

        case 'U':
            pargs->user = ptr+2;
            break;

        case 'b':
            pargs->batch = atol(ptr+2);
            break;

        case 'W':
            pargs->num_warehouses = atol(ptr+2);
            break;

        case 's':
            pargs->starting_warehouse = atol(ptr+2);
            break;

        case 't':
            {
                pargs->tables_all = FALSE;
                if ( strcmp(ptr+2,"item") == 0 )
            }
    }
}
```

Appendix B - Database Design

```
0)
TRUE;

        pargs->table_item = TRUE;
    else if (strcmp(ptr+2,"warehouse") ==
        pargs->table_warehouse =
    else if (strcmp(ptr+2,"customer") == 0)
        pargs->table_customer = TRUE;
    else if (strcmp(ptr+2,"orders") == 0)
        pargs->table_orders = TRUE;
    else
    {
        printf("\nUnrecognized command");
        GetArgsLoaderUsage();
        exit(1);
    }
    break;
}

case 'f':
    pargs->loader_res_file = ptr+2;
    break;

case 'p':
    pargs->pack_size = atol(ptr+2);
    break;

case 'i':
    pargs->build_index = atol(ptr+2);
    break;

case 'o':
    pargs->index_order = atol(ptr+2);
    break;

case 'c':
    pargs->scale_down = atol(ptr+2);
    break;

case 'd':
    pargs->index_script_path = ptr+2;
    break;

default:
    GetArgsLoaderUsage();
    exit(-1);
    break;
}

}

/* check for required args */
if (pargs->num_warehouses == UNDEF )
{
    printf("Number of Warehouses is required\n");
    exit(-2);
}

return;
}

//=====
//
```

```
// Function name: GetArgsLoaderUsage
//
//=====

void GetArgsLoaderUsage()
{
#ifdef DEBUG
    printf("[%ld]DBG: Entering GetArgsLoaderUsage()\n", (int) GetCurrentThreadId());
#endif

    printf("TPCCLDR:\n\n");
    printf("Parameter                                     Default\n");
    printf("-----\n");
    printf("-W Number of Warehouses to Load                Required \n");
    printf("-S Server                                         %s\n", SERVER);
    printf("-U Username                                       %s\n", USER);
    printf("-P Password                                       %s\n", PASSWORD);
    printf("-D Database                                       %s\n", DATABASE);
    printf("-b Batch Size                                     %ld\n", (long)
BATCH);
    printf("-p TDS packet size                             %ld\n", (long)
DEFLDPACKSIZE);
    printf("-f Loader Results Output Filename             %s\n",
LOADER_RES_FILE);
    printf("-s Starting Warehouse                           %ld\n", (long)
DEF_STARTING_WAREHOUSE);
    printf("-i Build Option (data = 0, data and index = 1) %ld\n", (long)
BUILD_INDEX);
    printf("-o Cluster Index Build Order (before = 1, after = 0) %ld\n", (long)
INDEX_ORDER);
    printf("-c Build Scaled Database (normal = 0, tiny = 1) %ld\n", (long)
SCALE_DOWN);
    printf("-d Index Script Path                           %s\n",
INDEX_SCRIPT_PATH);
    printf("-t Table to Load                                 all tables \n");
    printf(" [item|warehouse|customer|orders]\n");
    printf(" Notes: \n");
    printf(" - the '-t' parameter may be included multiple times to \n");
    printf(" - specify multiple tables to be loaded \n");
    printf(" - 'item' loads ITEM table \n");
    printf(" - 'warehouse' loads WAREHOUSE, DISTRICT, and STOCK tables \n");
    printf(" - 'customer' loads CUSTOMER and HISTORY tables \n");
    printf(" - 'orders' load NEW-ORDER, ORDERS, ORDER-LINE tables \n");

    printf("\nNote: Command line switches are case sensitive.\n");

    exit(0);
}

random.c

//      File:          RANDOM.C
//
//      Microsoft TPC-C Kit Ver. 4.00
//      Copyright Microsoft, 1996, 1997, 1998
```

Appendix B - Database Design

```
// Purpose: Random number generation routines for database loader

// Includes
#include "tpcc.h"
#include "math.h"

// Defines
#define A 16807
#define M 2147483647
#define Q 127773 /* M div A */
#define R 2836 /* M mod A */
#define Thread __declspec(thread)

// Globals
long Thread Seed = 0; /* thread local seed */

/*****
 *
 * random -
 * Implements a GOOD pseudo random number generator. This generator
 * will/should? run the complete period before repeating.
 *
 * Copied from:
 * Random Numbers Generators: Good Ones Are Hard to Find.
 * Communications of the ACM - October 1988 Volume 31 Number 10
 *
 * Machine Dependencies:
 * long must be 2 ^ 31 - 1 or greater.
 *
 *****/

/*****
 * seed - load the Seed value used in irand and drand. Should be used before
 * first call to irand or drand.
 *****/

void seed(long val)
{
#ifdef DEBUG
    printf("[%d]DBG: Entering seed()...\n", (int) GetCurrentThreadId());
    printf("Old Seed %ld New Seed %ld\n",Seed, val);
#endif

    if ( val < 0 )
        val = abs(val);

    Seed = val;
}

/*****
 *
 * irand - returns a 32 bit integer pseudo random number with a period of
 * 1 to 2 ^ 32 - 1.
 *
 * parameters:
 * none.
 *
 * returns:
 * 32 bit integer - defined as long ( see above ).
 *****/
```

```
*
* side effects:
* seed get recomputed.
*****/

long irand()
{
    register long s; /* copy of seed */
    register long test; /* test flag */
    register long hi; /* tmp value for speed */
    register long lo; /* tmp value for speed */

#ifdef DEBUG
    printf("[%d]DBG: Entering irand()...\n", (int) GetCurrentThreadId());
#endif

    s = Seed;
    hi = s / Q;
    lo = s % Q;

    test = A * lo - R * hi;
    if ( test > 0 )
        Seed = test;
    else
        Seed = test + M;

    return( Seed );
}

/*****
 *
 * drand - returns a double pseudo random number between 0.0 and 1.0.
 * See irand.
 *****/

double drand()
{
#ifdef DEBUG
    printf("[%d]DBG: Entering drand()...\n", (int) GetCurrentThreadId());
#endif

    return( (double)irand() / 2147483647.0 );
}

//=====
// Function : RandomNumber
//
// Description:
//=====
long RandomNumber(long lower, long upper)
{
    long rand_num;

#ifdef DEBUG
    printf("[%d]DBG: Entering RandomNumber()...\n", (int) GetCurrentThreadId());
#endif

    if ( upper == lower ) /* pgd 08-13-96 perf enhancement */
        return lower;

    upper++;
```

Appendix B - Database Design

```
    if ( upper <= lower )
        rand_num = upper;
    else
        rand_num = lower + irand() % (upper - lower); /* pgd 08-13-96 perf
enhancement */

#ifdef DEBUG
    printf("[%ld]DBG: RandomNumber between %ld & %ld ==> %ld\n",
           (int) GetCurrentThreadId(), lower, upper,
           rand_num);
#endif

    return rand_num;
}

#if 0
//Original code pgd 08/13/96
long RandomNumber(long lower,
                  long upper)
{
    long rand_num;

#ifdef DEBUG
    printf("[%ld]DBG: Entering RandomNumber()...\n", (int) GetCurrentThreadId());
#endif

    upper++;

    if ((upper <= lower))
        rand_num = upper;
    else
        rand_num = lower + irand() % ((upper > lower) ? upper - lower :
upper);

#ifdef DEBUG
    printf("[%ld]DBG: RandomNumber between %ld & %ld ==> %ld\n",
           (int) GetCurrentThreadId(), lower, upper,
           rand_num);
#endif

    return rand_num;
}
#endif

//=====
// Function : NURand
//
// Description:
//=====
long NURand(int iConst,
            long x,
            long y,
            long C)
{
    long rand_num;
```

```
#ifdef DEBUG
    printf("[%ld]DBG: Entering NURand()...\n", (int) GetCurrentThreadId());
#endif

    rand_num = (((RandomNumber(0,iConst) | RandomNumber(x,y)) + C) % (y-x+1))+x;

#ifdef DEBUG
    printf("[%ld]DBG: NURand: num = %d\n", (int) GetCurrentThreadId(), rand_num);
#endif

    return rand_num;
}
```

strings.c

```
// File: STRINGS.C
// Microsoft TPC-C Kit Ver. 4.00
// Copyright Microsoft, 1996, 1997, 1998
// Purpose: Source file for database loader string functions

// Includes
#include "tpcc.h"
#include <string.h>
#include <ctype.h>

//=====
// Function name: MakeAddress
//
//=====

void MakeAddress(char *street_1,
                char *street_2,
                char *city,
                char *state,
                char *zip)
{
#ifdef DEBUG
    printf("[%ld]DBG: Entering MakeAddress()\n", (int) GetCurrentThreadId());
#endif

    MakeAlphaString (10, 20, ADDRESS_LEN, street_1);
    MakeAlphaString (10, 20, ADDRESS_LEN, street_2);
    MakeAlphaString (10, 20, ADDRESS_LEN, city);
    MakeAlphaString ( 2,  2, STATE_LEN, state);
    MakeZipNumberString( 9,  9, ZIP_LEN, zip);

#ifdef DEBUG
    printf("[%ld]DBG: MakeAddress: street_1: %s, street_2: %s, city: %s, state: %s, zip:
%s\n",
           (int) GetCurrentThreadId(), street_1, street_2, city,
           state, zip);
#endif
}
```

Appendix B - Database Design

```
return;
}

//=====
//
// Function name: LastName
//
//=====

void LastName(int num,
              char *name)
{
    static char *n[] =
    {
        "BAR", "OUGHT", "ABLE", "PRI", "PRES",
        "ESE", "ANTI", "CALLY", "ATION", "EING"
    };

#ifdef DEBUG
    printf("[%ld]DBG: Entering LastName()\n", (int) GetCurrentThreadId());
#endif

    if ((num >= 0) && (num < 1000))
    {
        strcpy(name, n[(num/100)%10]);
        strcat(name, n[(num/10)%10]);
        strcat(name, n[(num/1)%10]);

        if (strlen(name) < LAST_NAME_LEN)
        {
            PaddString(LAST_NAME_LEN, name);
        }
    }
    else
    {
        printf("\nError in LastName()... num < %ld> out of range (0,999)\n",
            num);
        exit(-1);
    }

#ifdef DEBUG
    printf("[%ld]DBG: LastName: num = [%d] ==> [%d][%d][%d]\n",
        (int) GetCurrentThreadId(), num, num/100, (num/10)%10,
        num%10);
    printf("[%ld]DBG: LastName: String = %s\n", (int) GetCurrentThreadId(), name);
#endif

    return;
}

//=====
//
// Function name: MakeAlphaString
//
//=====
```

```
//philipdu 08/13/96 Changed MakeAlphaString to use A-Z, a-z, and 0-9 in
//accordance with spec see below:
//The spec says:
//4.3.2.2 The notation random a-string [x .. y]
//(respectively, n-string [x .. y]) represents a string of random alphanumeric
//(respectively, numeric) characters of a random length of minimum x, maximum y,
//and mean (y+x)/2. Alphanumerics are A..Z, a..z, and 0..9. The only other
//requirement is that the character set used "must be able to represent a minimum
//of 128 different characters". We are using 8-bit chars, so this is a non issue.
//It is completely unreasonable to stuff non-printing chars into the text fields.
//-CLevine 08/13/96

int MakeAlphaString( int x, int y, int z, char *str)
{
    int len;
    int i;
    static char chArray[] =
    "0123456789ABCDEFGHIJKLMNOPQRSTUVWXYZabcdefghijklmnopqrstuvwxyz";
    static int chArrayMax = 61;

#ifdef DEBUG
    printf("[%ld]DBG: Entering MakeAlphaString()\n", (int) GetCurrentThreadId());
#endif

    len= RandomNumber(x, y);

    for (i=0; i<len; i++)
        str[i] = chArray[RandomNumber(0, chArrayMax)];
    if ( len < z )
        memset(str+len, ' ', z - len);
    str[len] = 0;

    return len;
}

//=====
//
// Function name: MakeOriginalAlphaString
//
//=====

int MakeOriginalAlphaString(int x,
                            int y,
                            int z,
                            char *str,
                            int percent)
{
    int len;
    int val;
    int start;

#ifdef DEBUG
    printf("[%ld]DBG: Entering MakeOriginalAlphaString()\n", (int) GetCurrentThreadId());
#endif

    // verify percentage is valid
    if ((percent < 0) || (percent > 100))
    {
        printf("MakeOriginalAlphaString: Invalid percentage: %d\n", percent);
        exit(-1);
    }
}
```

Appendix B - Database Design

```
// verify string is at least 8 chars in length
if ((x + y) <= 8)
{
    printf("MakeOriginalAlphaString: string length must be >= 8\n");
    exit(-1);
}

// Make Alpha String
len = MakeAlphaString(x,y, z, str);

val = RandomNumber(1,100);
if (val <= percent)
{
    start = RandomNumber(0, len - 8);
    strncpy(str + start, "ORIGINAL", 8);
}

#ifdef DEBUG
printf("[%ld]DBG: MakeOriginalAlphaString: : %s\n",
       (int) GetCurrentThreadId(), str);
#endif

return strlen(str);
}

//=====
//
// Function name: MakeNumberString
//
//=====
int MakeNumberString(int x, int y, int z, char *str)
{
    char tmp[16];

    //MakeNumberString is always called MakeZipNumberString(16, 16, 16, string)

    memset(str, '0', 16);
    itoa(RandomNumber(0, 99999999), tmp, 10);
    memcpy(str, tmp, strlen(tmp));

    itoa(RandomNumber(0, 99999999), tmp, 10);
    memcpy(str+8, tmp, strlen(tmp));

    str[16] = 0;

    return 16;
}

//=====
//
// Function name: MakeZipNumberString
//
//=====
int MakeZipNumberString(int x, int y, int z, char *str)
{
    char tmp[16];

    //MakeZipNumberString is always called MakeZipNumberString(9, 9, 9, string)

    strcpy(str, "000011111");
}
```

```
        itoa(RandomNumber(0, 9999), tmp, 10);
        memcpy(str, tmp, strlen(tmp));

    }
    return 9;
}

//=====
//
// Function name: InitString
//
//=====
void InitString(char *str, int len)
{
#ifdef DEBUG
    printf("[%ld]DBG: Entering InitString()\n", (int) GetCurrentThreadId());
#endif

    memset(str, ' ', len);
    str[len] = 0;
}

//=====
// Function name: InitAddress
//
// Description:
//
//=====
void InitAddress(char *street_1, char *street_2, char *city, char *state, char *zip)
{
    memset(street_1, ' ', ADDRESS_LEN+1);
    memset(street_2, ' ', ADDRESS_LEN+1);
    memset(city, ' ', ADDRESS_LEN+1);

    street_1[ADDRESS_LEN+1] = 0;
    street_2[ADDRESS_LEN+1] = 0;
    city[ADDRESS_LEN+1] = 0;

    memset(state, ' ', STATE_LEN+1);
    state[STATE_LEN+1] = 0;

    memset(zip, ' ', ZIP_LEN+1);
    zip[ZIP_LEN+1] = 0;
}

//=====
//
// Function name: PaddString
//
//=====
void PaddString(int max, char *name)
{
    int len;

    len = strlen(name);
    if ( len < max )
        memset(name+len, ' ', max - len);
    name[max] = 0;
}
```

Appendix B - Database Design

```
        return;  
    }
```

time.c

```
//      File:          TIME.C  
//      Microsoft TPC-C Kit Ver. 4.00  
//      Copyright Microsoft, 1996, 1997, 1998  
//      Purpose:  Source file for time functions  
  
// Includes  
#include "tpcc.h"  
  
// Globals  
static long start_sec;  
  
//=====  
//  
// Function name: TimeNow  
//  
//=====  
  
long TimeNow()  
{  
    long      time_now;  
    struct _timeb el_time;  
  
#ifdef DEBUG  
    printf("[%ld]DBG: Entering TimeNow()\n", (int) GetCurrentThreadId());  
#endif  
  
    _ftime(&el_time);  
  
    time_now = ((el_time.time - start_sec) * 1000) + el_time.millitm;  
  
    return time_now;  
}
```

Appendix C – Tunable Parameters

Appendix C - Tunable Parameters

Server Configuration Parameters

Microsoft Windows .NET Enterprise Server Parameters

The following registry key was added to disable the kernel counters for Global and Per-Process I/Os:

```
[HKEY_LOCAL_MACHINE\SYSTEM\CurrentControlSet\Control\Session Manager\I/O System]
"CountOperations"=dword:00000000
```

Microsoft Windows .NET Enterprise Server Configuration

The following services were disabled on the server:

- Alerter
- Automatic Updates
- Computer Browser
- Cryptographic Services
- DHCP Client
- Distributed File System
- Distributed Link Tracking Client
- DNS Client
- Global Array Manager Server
- Help and Support
- IPSEC Policy Agent
- License Logging Service
- Messenger
- MSSQLserver
- Microsoft Search
- Print Spooler
- Process Control Service
- Remote Registry Service
- Removable Storage
- Run as Service
- System Event Notification
- SSDP Discovery service
- Task Scheduler
- Wireless configuration

Microsoft SQL Server 2000 Startup Parameters

Microsoft SQL Server was started with the following command line options

```
sqlservr -c -x -T3502 -g100
```

where

-c Start SQL Server independently of the Microsoft Windows NT Service

Appendix C – Tunable Parameters

	Control Manager.
-x	Disable the keeping of CPU time and cache-hit ratio statistics.
-T3502	Prints a message to the log at the beginning and end of each checkpoint.
-g100	Reserve 100 MB for non-buffer pool allocations

Microsoft SQL Server Stack Size

The default stack size of Microsoft SQL Server was changed using the EDITBIN utility. The EDITBIN utility ships with Microsoft Visual C++ V5.0. The command used was editbin /stack:131072 sqlservr.exe.

Mylex Device Drivers and Firmware

The following device drivers were added:

- Mylex BIOS: 6:00-05
- Mylex Firmware: 6.00-02 bld 127
- Miniport driver : 7.00-14 (dac2w2k.sys)
- Accelerated Driver : 7.00-14 (macxp32.sys)

Microsoft SQL Server 2000 Configuration Parameters

name	minimum	maximum	config_value	run_value
affinity mask	0	2147483647	255	255
allow updates	0	1	1	1
c2 audit mode	0	1	0	0
cost threshold for parallelism	0	32767	5	5
cursor threshold	-1	2147483647	-1	-1
default full-text language	0	2147483647	1033	1033
default language	0	9999	0	0
fill factor (%)	0	100	0	0
index create memory (KB)	704	1600000	0	0
language in cache	3	100	3	3
lightweight pooling	0	1	1	1
locks	5000	2147483647	0	0
max degree of parallelism	0	32	1	1
max server memory (MB)	4	2147483647	31000	31000
max text repl size (B)	0	2147483647	65536	65536
max worker threads	10	1024	320	320
media retention	0	365	0	0
min memory per query (KB)	512	2147483647	1024	1024
min server memory (MB)	0	2147483647	0	0
nested triggers	0	1	1	1
network packet size (B)	512	65535	4096	4096
open objects	0	2147483647	0	0
priority boost	0	1	1	1
query governor cost limit	0	2147483647	0	0
query wait (s)	-1	2147483647	-1	-1
recovery interval (min)	0	32767	80	80
remote access	0	1	0	0
remote login timeout (s)	0	2147483647	5	5
remote proc trans	0	1	0	0
remote query timeout (s)	0	2147483647	0	0
scan for startup procs	0	1	0	0
set working set size	0	1	0	0
show advanced options	0	1	1	1
two digit year cutoff	1753	9999	2049	2049
user connections	0	32767	0	0
user options	0	16383	0	0

Appendix C – Tunable Parameters

Windows .NET Enterprise Server System Information Report For PE6600

OS Name Microsoft® Windows® .NET Enterprise Server
Version 5.2.3663 Build 3663
OS Manufacturer Microsoft Corporation
System Name PE6500

Appendix C – Tunable Parameters

System Manufacturer Dell Computer Corporation
System Model PowerEdge 6600
System Type X86-based PC
Processor x86 Family 15 Model 2 Stepping 2 GenuineIntel ~1989 Mhz
Processor x86 Family 15 Model 2 Stepping 2 GenuineIntel ~1989 Mhz
Processor x86 Family 15 Model 2 Stepping 2 GenuineIntel ~1989 Mhz
Processor x86 Family 15 Model 2 Stepping 2 GenuineIntel ~1989 Mhz
Processor x86 Family 15 Model 2 Stepping 2 GenuineIntel ~1989 Mhz
Processor x86 Family 15 Model 2 Stepping 2 GenuineIntel ~1989 Mhz
Processor x86 Family 15 Model 2 Stepping 2 GenuineIntel ~1989 Mhz
Processor x86 Family 15 Model 2 Stepping 2 GenuineIntel ~1989 Mhz
BIOS Version/Date Dell Computer Corporation X32, 12/17/2002
SMBIOS Version 2.3
Windows Directory C:\WINDOWS
System Directory C:\WINDOWS\system32
Boot Device \Device\HarddiskVolume1
Locale United States
Hardware Abstraction Layer Version = "5.2.3663.0 (main.020715-1506)"
User Name PE6500\Administrator
Time Zone Central Standard Time
Total Physical Memory 32,768.00 MB
Available Physical Memory 1.19 GB
Total Virtual Memory 91.45 GB
Available Virtual Memory 31.66 GB
Page File Space 60.20 GB
Page File V:\pagefile.sys

Conflicts/Sharing

Memory Address 0xF0000000-0xF18FFFFFFF	PCI bus
Memory Address 0xF0000000-0xF18FFFFFFF	DEC 21154 PCI to PCI bridge
Memory Address 0xF0000000-0xF18FFFFFFF	Mylex eXtremeRAID 2000 Disk
Array Controller (Accelerated)	
I/O Port 0x0000A000-0x0000AFFF	PCI bus
I/O Port 0x0000A000-0x0000AFFF	DEC 21154 PCI to PCI bridge
I/O Port 0x00000000-0x000003AF	PCI bus
I/O Port 0x00000000-0x000003AF	Direct memory access controller
Memory Address 0xF0800000-0xF17FFFFFFF	DEC 21154 PCI to PCI bridge
Memory Address 0xF0800000-0xF17FFFFFFF	Mylex eXtremeRAID 2000 Disk
Array Controller (Accelerated)	
Memory Address 0xF2800000-0xF37FFFFFFF	DEC 21154 PCI to PCI bridge
Memory Address 0xF2800000-0xF37FFFFFFF	Mylex eXtremeRAID 2000 Disk
Array Controller (Accelerated)	
Memory Address 0xF4000000-0xFC8FFFFFFF	PCI bus
Memory Address 0xF4000000-0xFC8FFFFFFF	DEC 21154 PCI to PCI bridge
Memory Address 0xF4000000-0xFC8FFFFFFF	Mylex eXtremeRAID 2000 Disk
Array Controller (Accelerated)	
Memory Address 0xE5800000-0xE67FFFFFFF	DEC 21154 PCI to PCI bridge

Appendix C – Tunable Parameters

Memory Address 0xE5800000-0xE67FFFFFFF Array Controller (Accelerated)	Mylex eXtremeRAID 2000 Disk
Memory Address 0xE8000000-0xEF8FFFFFFF	PCI bus
Memory Address 0xE8000000-0xEF8FFFFFFF	DEC 21154 PCI to PCI bridge
Memory Address 0xE8000000-0xEF8FFFFFFF Array Controller (Accelerated)	Mylex eXtremeRAID 2000 Disk
I/O Port 0x00009000-0x00009FFF	PCI bus
I/O Port 0x00009000-0x00009FFF	DEC 21154 PCI to PCI bridge
Memory Address 0xF2000000-0xF38FFFFFFF	PCI bus
Memory Address 0xF2000000-0xF38FFFFFFF	DEC 21154 PCI to PCI bridge
Memory Address 0xF2000000-0xF38FFFFFFF Array Controller (Accelerated)	Mylex eXtremeRAID 2000 Disk
I/O Port 0x0000B000-0x0000BFFF	PCI bus
I/O Port 0x0000B000-0x0000BFFF	DEC 21154 PCI to PCI bridge
IRQ 15 System board	
IRQ 15 Secondary IDE Channel	
Memory Address 0xFD000000-0xFE1FFFFFFF	PCI bus
Memory Address 0xFD000000-0xFE1FFFFFFF Corporation)	RAGE XL PCI (Microsoft
Memory Address 0xE0000000-0xE3FFFFFFF	DEC 21154 PCI to PCI bridge
Memory Address 0xE0000000-0xE3FFFFFFF Array Controller (Accelerated)	Mylex eXtremeRAID 2000 Disk
Memory Address 0xE6800000-0xE77FFFFFFF	DEC 21154 PCI to PCI bridge
Memory Address 0xE6800000-0xE77FFFFFFF Array Controller (Accelerated)	Mylex eXtremeRAID 2000 Disk
Memory Address 0xEE800000-0xEF7FFFFFFF	DEC 21154 PCI to PCI bridge
Memory Address 0xEE800000-0xEF7FFFFFFF Array Controller (Accelerated)	Mylex eXtremeRAID 2000 Disk
Memory Address 0xA0000-0xBFFFFFFF	PCI bus
Memory Address 0xA0000-0xBFFFFFFF	RAGE XL PCI (Microsoft Corporation)
I/O Port 0x00007000-0x00008FFF	PCI bus
I/O Port 0x00007000-0x00008FFF	DEC 21154 PCI to PCI bridge
I/O Port 0x000003B0-0x000003DF	PCI bus
I/O Port 0x000003B0-0x000003DF	RAGE XL PCI (Microsoft Corporation)
Memory Address 0xFB800000-0xFC7FFFFFFF	DEC 21154 PCI to PCI bridge
Memory Address 0xFB800000-0xFC7FFFFFFF Array Controller (Accelerated)	Mylex eXtremeRAID 2000 Disk
Memory Address 0xDC000000-0xE78FFFFFFF	PCI bus
Memory Address 0xDC000000-0xE78FFFFFFF	DEC 21154 PCI to PCI bridge
Memory Address 0xDC000000-0xE78FFFFFFF Array Controller (Accelerated)	Mylex eXtremeRAID 2000 Disk

Appendix C – Tunable Parameters

I/O Port 0x0000D000-0x0000DFFF PCI bus
I/O Port 0x0000D000-0x0000DFFF DEC 21154 PCI to PCI bridge

DMA

Channel 2 Standard floppy disk controller OK
Channel 4 Direct memory access controller OK

I/O

0x00000000-0x000003AF PCI bus OK
0x00000000-0x000003AF Direct memory access controller OK
0x00000020-0x0000003F Programmable interrupt controller OK
0x00000040-0x0000005F System timer OK
0x00000060-0x00000060 Standard 101/102-Key or Microsoft Natural PS/2
Keyboard OK
0x00000061-0x00000061 System speaker OK
0x00000064-0x00000064 Standard 101/102-Key or Microsoft Natural PS/2
Keyboard OK
0x00000070-0x0000007F System CMOS/real time clock OK
0x00000080-0x0000009F Direct memory access controller OK
0x000000A0-0x000000BF Programmable interrupt controller OK
0x000000C0-0x000000DF Direct memory access controller OK
0x000000E0-0x000000EF System board OK
0x000000F0-0x000000FF Numeric data processor OK
0x00000170-0x00000177 Secondary IDE Channel OK
0x000001F0-0x000001F7 Primary IDE Channel OK
0x00000274-0x00000277 ISAPNP Read Data Port OK
0x00000279-0x00000279 ISAPNP Read Data Port OK
0x00000376-0x00000376 Secondary IDE Channel OK
0x000003B0-0x000003DF PCI bus OK
0x000003B0-0x000003DF RAGE XL PCI (Microsoft Corporation) OK
0x000003C0-0x000003DF RAGE XL PCI (Microsoft Corporation) OK
0x000003E0-0x00000CF7 PCI bus OK
0x000003F0-0x000003F5 Standard floppy disk controller OK
0x000003F6-0x000003F6 Primary IDE Channel OK
0x000003F7-0x000003F7 Standard floppy disk controller OK
0x000003F8-0x000003FF Communications Port (COM1) OK
0x0000040B-0x0000040B Direct memory access controller OK
0x000004D0-0x000004D1 Programmable interrupt controller OK
0x000004D6-0x000004D6 Direct memory access controller OK
0x00000800-0x0000087F System board OK
0x000008A0-0x000008AF System board OK
0x000008B0-0x000008BF Standard Dual Channel PCI IDE Controller OK
0x000008E0-0x000008E3 System board OK
0x00000A79-0x00000A79 ISAPNP Read Data Port OK
0x00000C00-0x00000CD7 System board OK
0x00000D00-0x00000FFF PCI bus OK
0x00000F50-0x00000F58 System board OK
0x00007000-0x00008FFF PCI bus OK
0x00007000-0x00008FFF DEC 21154 PCI to PCI bridge OK
0x00007C80-0x00007CFF Mylex eXtremeRAID 2000 Disk Array Controller
(Accelerated) OK
0x00008000-0x00008FFF DEC 21154 PCI to PCI bridge OK

Appendix C – Tunable Parameters

0x00008C80-0x00008CFF (Accelerated) OK	Mylex eXtremeRAID 2000 Disk Array Controller
0x00009000-0x00009FFF	PCI bus OK
0x00009000-0x00009FFF	DEC 21154 PCI to PCI bridge OK
0x00009C80-0x00009CFF (Accelerated) OK	Mylex eXtremeRAID 2000 Disk Array Controller
0x0000A000-0x0000AFFF	PCI bus OK
0x0000A000-0x0000AFFF	DEC 21154 PCI to PCI bridge OK
0x0000AC80-0x0000ACFF (Accelerated) OK	Mylex eXtremeRAID 2000 Disk Array Controller
0x0000B000-0x0000BFFF	PCI bus OK
0x0000B000-0x0000BFFF	DEC 21154 PCI to PCI bridge OK
0x0000BC80-0x0000BCFF (Accelerated) OK	Mylex eXtremeRAID 2000 Disk Array Controller
0x0000C000-0x0000CFFF	PCI bus OK
0x0000D000-0x0000DFFF	PCI bus OK
0x0000D000-0x0000DFFF	DEC 21154 PCI to PCI bridge OK
0x0000DC80-0x0000DCFF (Accelerated) OK	Mylex eXtremeRAID 2000 Disk Array Controller
0x0000E000-0x0000EFFF	PCI bus OK
0x0000E800-0x0000E8FF	RAGE XL PCI (Microsoft Corporation) OK
0x0000EC00-0x0000ECFF	Adaptec AIC-7892 Ultra160 PCI SCSI Card OK

IRQ

IRQ 0	System timer	OK
IRQ 1	Standard 101/102-Key or Microsoft Natural PS/2 Keyboard	OK
IRQ 4	Communications Port (COM1)	OK
IRQ 6	Standard floppy disk controller	OK
IRQ 8	System CMOS/real time clock	OK
IRQ 9	Microsoft ACPI-Compliant System	OK
IRQ 12	PS/2 Compatible Mouse	OK
IRQ 13	Numeric data processor	OK
IRQ 14	Primary IDE Channel	OK
IRQ 15	System board	OK
IRQ 15	Secondary IDE Channel	OK
IRQ 16	Adaptec AIC-7892 Ultra160 PCI SCSI Card	OK
IRQ 17	Broadcom NetXtreme Gigabit Ethernet #2	OK
IRQ 18	Broadcom NetXtreme Gigabit Ethernet	OK
IRQ 21	Mylex eXtremeRAID 2000 Disk Array Controller (Accelerated)	OK
IRQ 23	Mylex eXtremeRAID 2000 Disk Array Controller (Accelerated)	OK
IRQ 25	Mylex eXtremeRAID 2000 Disk Array Controller (Accelerated)	OK
IRQ 27	Mylex eXtremeRAID 2000 Disk Array Controller (Accelerated)	OK
IRQ 28	Mylex eXtremeRAID 2000 Disk Array Controller (Accelerated)	OK
IRQ 30	Mylex eXtremeRAID 2000 Disk Array Controller (Accelerated)	OK

Memory

0xFD000000-0xFE1FFFFFF	PCI bus	OK
------------------------	---------	----

Appendix C – Tunable Parameters

0xFD000000-0xFE1FFFFFF	RAGE XL PCI (Microsoft Corporation) OK
0xFE101000-0xFE101FFF	Adaptec AIC-7892 Ultra160 PCI SCSI Card OK
0xFE100000-0xFE100FFF	RAGE XL PCI (Microsoft Corporation) OK
0xF4000000-0xFC8FFFFFF	PCI bus OK
0xF4000000-0xFC8FFFFFF	DEC 21154 PCI to PCI bridge OK
0xF4000000-0xFC8FFFFFF	Mylex eXtremeRAID 2000 Disk Array Controller (Accelerated) OK
0xFB800000-0xFC7FFFFFF	DEC 21154 PCI to PCI bridge OK
0xFB800000-0xFC7FFFFFF	Mylex eXtremeRAID 2000 Disk Array Controller (Accelerated) OK
0xF3E00000-0xF3FFFFFF	PCI bus OK
0xF3F10000-0xF3F1FFFF	Broadcom NetXtreme Gigabit Ethernet #2 OK
0xF3F00000-0xF3F0FFFF	Broadcom NetXtreme Gigabit Ethernet OK
0xF2000000-0xF38FFFFFF	PCI bus OK
0xF2000000-0xF38FFFFFF	DEC 21154 PCI to PCI bridge OK
0xF2000000-0xF38FFFFFF	Mylex eXtremeRAID 2000 Disk Array Controller (Accelerated) OK
0xF2800000-0xF37FFFFFF	DEC 21154 PCI to PCI bridge OK
0xF2800000-0xF37FFFFFF	Mylex eXtremeRAID 2000 Disk Array Controller (Accelerated) OK
0xF0000000-0xF18FFFFFF	PCI bus OK
0xF0000000-0xF18FFFFFF	DEC 21154 PCI to PCI bridge OK
0xF0000000-0xF18FFFFFF	Mylex eXtremeRAID 2000 Disk Array Controller (Accelerated) OK
0xF0800000-0xF17FFFFFF	DEC 21154 PCI to PCI bridge OK
0xF0800000-0xF17FFFFFF	Mylex eXtremeRAID 2000 Disk Array Controller (Accelerated) OK
0xE8000000-0xEF8FFFFFF	PCI bus OK
0xE8000000-0xEF8FFFFFF	DEC 21154 PCI to PCI bridge OK
0xE8000000-0xEF8FFFFFF	Mylex eXtremeRAID 2000 Disk Array Controller (Accelerated) OK
0xEE800000-0xEF7FFFFFF	DEC 21154 PCI to PCI bridge OK
0xEE800000-0xEF7FFFFFF	Mylex eXtremeRAID 2000 Disk Array Controller (Accelerated) OK
0xDC000000-0xE78FFFFFF	PCI bus OK
0xDC000000-0xE78FFFFFF	DEC 21154 PCI to PCI bridge OK
0xDC000000-0xE78FFFFFF	Mylex eXtremeRAID 2000 Disk Array Controller (Accelerated) OK
0xE6800000-0xE77FFFFFF	DEC 21154 PCI to PCI bridge OK
0xE6800000-0xE77FFFFFF	Mylex eXtremeRAID 2000 Disk Array Controller (Accelerated) OK
0xE0000000-0xE3FFFFFF	DEC 21154 PCI to PCI bridge OK
0xE0000000-0xE3FFFFFF	Mylex eXtremeRAID 2000 Disk Array Controller (Accelerated) OK
0xE5800000-0xE67FFFFFF	DEC 21154 PCI to PCI bridge OK
0xE5800000-0xE67FFFFFF	Mylex eXtremeRAID 2000 Disk Array Controller (Accelerated) OK
0xA0000-0xBFFFF	PCI bus OK
0xA0000-0xBFFFF	RAGE XL PCI (Microsoft Corporation) OK
0xD8000-0xE7FFF	PCI bus OK

System Information report written at: 12/19/02 11:28:59

System Name: PE6500

[Components]

Appendix C – Tunable Parameters

[Multimedia]

[Audio Codecs]

CODEC	Manufacturer	Description	Status	File	Version	Size
		Creation Date				
c:\windows\system32\l3codeca.acm	Fraunhofer Institut	Integrierte Schaltungen IIS	Fraunhofer IIS MPEG Layer-3 Codec	OK		
		C:\WINDOWS\system32\L3CODECA.ACM	1, 9, 0, 0305		284.00 KB	
		(290,816 bytes)	7/29/2002 1:25 PM			
c:\windows\system32\sl_anet.acm	Sipro Lab Telecom Inc.	Sipro Lab Telecom Audio Codec	OK	C:\WINDOWS\system32\SL_ANET.ACM	3.02	
		84.00 KB (86,016 bytes)	7/29/2002 1:56 PM			
c:\windows\system32\msadp32.acm	Microsoft Corporation				OK	
		C:\WINDOWS\system32\MSADP32.ACM	5.2.3663.0 (main.020715-1506)			
		14.50 KB (14,848 bytes)	7/29/2002 1:31 PM			
c:\windows\system32\msaud32.acm	Microsoft Corporation	Windows Media Audio Codec	OK	C:\WINDOWS\system32\MSAUD32.ACM		
		8.00.00.4477	288.00 KB (294,912 bytes)	7/29/2002 1:31 PM		
c:\windows\system32\tssoft32.acm	DSP GROUP, INC.				OK	
		C:\WINDOWS\system32\TSSOFT32.ACM	1.01 9.50 KB (9,728 bytes)	7/29/2002 2:00 PM		
c:\windows\system32\msg723.acm	Microsoft Corporation				OK	
		C:\WINDOWS\system32\MSG723.ACM	4.4.4000	116.00 KB		
		(118,784 bytes)	9/25/2002 12:08 PM			
c:\windows\system32\msgsm32.acm	Microsoft Corporation				OK	
		C:\WINDOWS\system32\MSGSM32.ACM	5.2.3663.0 (main.020715-1506)			
		20.00 KB (20,480 bytes)	7/29/2002 1:32 PM			
c:\windows\system32\imaadp32.acm	Microsoft Corporation				OK	
		C:\WINDOWS\system32\IMAADP32.ACM	5.2.3663.0 (main.020715-1506)			
		15.50 KB (15,872 bytes)	7/29/2002 1:22 PM			
c:\windows\system32\msg711.acm	Microsoft Corporation				OK	
		C:\WINDOWS\system32\MSG711.ACM	5.2.3663.0 (main.020715-1506)			
		10.00 KB (10,240 bytes)	7/29/2002 1:32 PM			

[Video Codecs]

CODEC	Manufacturer	Description	Status	File	Version	Size
		Creation Date				
c:\windows\system32\msh261.drv	Microsoft Corporation				OK	
		C:\WINDOWS\system32\MSH261.DRV	4.4.4000	180.00 KB		
		(184,320 bytes)	9/25/2002 12:08 PM			
c:\windows\system32\tsbyuv.dll	Microsoft Corporation				OK	
		C:\WINDOWS\system32\TSBYUV.DLL	5.2.3663.0 (main.020715-1506)			
		8.00 KB (8,192 bytes)	7/16/2002 8:48 AM			
c:\windows\system32\iyuv_32.dll	Microsoft Corporation				OK	
		C:\WINDOWS\system32\IYUV_32.DLL	5.2.3663.0 (main.020715-1506)			
		45.00 KB (46,080 bytes)	7/16/2002 8:47 AM			
c:\windows\system32\msrle32.dll	Microsoft Corporation				OK	
		C:\WINDOWS\system32\MSRLE32.DLL	5.2.3663.0 (main.020715-1506)			
		10.50 KB (10,752 bytes)	7/29/2002 1:33 PM			

Appendix C – Tunable Parameters

c:\windows\system32\ir32_32.dll Not Available OK
C:\WINDOWS\system32\IR32_32.DLL Not Available 194.50 KB
(199,168 bytes) 7/29/2002 1:24 PM
c:\windows\system32\iccvid.dll Radius Inc. OK
C:\WINDOWS\system32\ICCVID.DLL 1.10.0.6 108.00 KB
(110,592 bytes) 7/29/2002 1:21 PM
c:\windows\system32\msh263.driv Microsoft Corporation OK
C:\WINDOWS\system32\MSH263.DRV 4.4.4000 280.00 KB
(286,720 bytes) 7/16/2002 8:46 AM
c:\windows\system32\msyuv.dll Microsoft Corporation OK
C:\WINDOWS\system32\MSYUV.DLL 5.2.3663.0 (main.020715-1506) 16.50
KB (16,896 bytes) 7/16/2002 8:47 AM
c:\windows\system32\msvidc32.dll Microsoft Corporation OK
C:\WINDOWS\system32\MSVIDC32.DLL 5.2.3663.0 (main.020715-1506)
26.50 KB (27,136 bytes) 7/29/2002 1:33 PM

[CD-ROM]

Item Value
Drive P:
Description CD-ROM Drive
Media Loaded Yes
Media Type CD-ROM
Name TEAC CD-224E
Manufacturer (Standard CD-ROM drives)
Status OK
Transfer Rate Not Available
SCSI Target ID 0
PNP Device ID IDE\CDROMTEAC_CD-
224E_____3.7D____\5&3125DC91&0&0.0.0
Driver c:\windows\system32\drivers\cdrom.sys (5.2.3663.0
(main.020715-1506), 47.75 KB (48,896 bytes), 7/29/2002 1:10 PM)

[Sound Device]

Item Value

[Display]

Item Value
Name RAGE XL PCI (Microsoft Corporation)
PNP Device ID
PCI\VEN_1002&DEV_4752&SUBSYS_01091028&REV_27\3&13C0B0C5&0&20
Adapter Type ATI RAGE XL PCI (B41), ATI Technologies Inc.
compatible
Adapter Description RAGE XL PCI (Microsoft Corporation)
Adapter RAM 8.00 MB (8,388,608 bytes)
Installed Drivers ati2drad.dll
Driver Version 5.10.2600.6009
INF File atiixpad.inf (ati2mpad section)
Color Planes 1
Color Table Entries 4294967296
Resolution 1024 x 768 x 85 hertz
Bits/Pixel 32
Memory Address 0xFD000000-0xFE1FFFFFF

Appendix C – Tunable Parameters

I/O Port 0x0000E800-0x0000E8FF
Memory Address 0xFE100000-0xFE100FFF
I/O Port 0x000003B0-0x000003DF
I/O Port 0x000003C0-0x000003DF
Memory Address 0xA0000-0xBFFFF
Driver c:\windows\system32\drivers\ati2mpad.sys (5.10.2600.6009
built by: jlu, 296.13 KB (303,232 bytes), 9/25/2002 6:58 AM)

[Infrared]

Item Value

[Input]

[Keyboard]

Item Value

Description Standard 101/102-Key or Microsoft Natural PS/2 Keyboard
Name Enhanced (101- or 102-key)
Layout 00000409
PNP Device ID ACPI\PNP0303\4&25F73A82&0
Number of Function Keys 12
I/O Port 0x00000060-0x00000060
I/O Port 0x00000064-0x00000064
IRQ Channel IRQ 1
Driver c:\windows\system32\drivers\i8042prt.sys (5.2.3663.0
(main.020715-1506), 50.50 KB (51,712 bytes), 7/29/2002 1:21 PM)

[Pointing Device]

Item Value

Hardware Type PS/2 Compatible Mouse
Number of Buttons 2
Status OK
PNP Device ID ACPI\PNP0F13\4&25F73A82&0
Power Management Supported No
Double Click Threshold 6
Handedness Right Handed Operation
IRQ Channel IRQ 12
Driver c:\windows\system32\drivers\i8042prt.sys (5.2.3663.0
(main.020715-1506), 50.50 KB (51,712 bytes), 7/29/2002 1:21 PM)

[Modem]

Item Value

[Network]

[Adapter]

Item Value

Appendix C – Tunable Parameters

Name [00000001] Broadcom NetXtreme Gigabit Ethernet
Adapter Type Ethernet 802.3
Product Type Broadcom NetXtreme Gigabit Ethernet
Installed Yes
PNP Device ID
PCI\VEN_14E4&DEV_1644&SUBSYS_01091028&REV_14\3&29E81982&0&10
Last Reset 12/18/2002 12:15 PM
Index 1
Service Name b57w2k
IP Address 0.0.0.0
IP Subnet 0.0.0.0
Default IP Gateway Not Available
DHCP Enabled No
DHCP Server Not Available
DHCP Lease Expires Not Available
DHCP Lease Obtained Not Available
MAC Address 00:06:5B:8F:F9:EC
Memory Address 0xF3F00000-0xF3F0FFFF
IRQ Channel IRQ 18
Driver c:\windows\system32\drivers\b57xp32.sys (2.67.0.0 built by:
WinDDK, 131.63 KB (134,784 bytes), 9/25/2002 6:59 AM)

Name [00000002] Broadcom NetXtreme Gigabit Ethernet
Adapter Type Ethernet 802.3
Product Type Broadcom NetXtreme Gigabit Ethernet
Installed Yes
PNP Device ID
PCI\VEN_14E4&DEV_1644&SUBSYS_01091028&REV_14\3&29E81982&0&08
Last Reset 12/18/2002 12:15 PM
Index 2
Service Name b57w2k
IP Address 192.1.1.101
IP Subnet 255.255.255.0
Default IP Gateway Not Available
DHCP Enabled No
DHCP Server Not Available
DHCP Lease Expires Not Available
DHCP Lease Obtained Not Available
MAC Address 00:06:5B:8F:F9:EB
Memory Address 0xF3F10000-0xF3F1FFFF
IRQ Channel IRQ 17
Driver c:\windows\system32\drivers\b57xp32.sys (2.67.0.0 built by:
WinDDK, 131.63 KB (134,784 bytes), 9/25/2002 6:59 AM)

Name [00000003] RAS Async Adapter
Adapter Type Not Available
Product Type RAS Async Adapter
Installed Yes
PNP Device ID Not Available
Last Reset 12/18/2002 12:15 PM
Index 3
Service Name AsyncMac
IP Address Not Available
IP Subnet Not Available
Default IP Gateway Not Available

Appendix C – Tunable Parameters

DHCP Enabled No
DHCP Server Not Available
DHCP Lease Expires Not Available
DHCP Lease Obtained Not Available
MAC Address Not Available

Name [00000004] WAN Miniport (L2TP)
Adapter Type Not Available
Product Type WAN Miniport (L2TP)
Installed Yes
PNP Device ID ROOT\MS_L2TPMINIPOINT\0000
Last Reset 12/18/2002 12:15 PM
Index 4
Service Name Rasl2tp
IP Address Not Available
IP Subnet Not Available
Default IP Gateway Not Available
DHCP Enabled No
DHCP Server Not Available
DHCP Lease Expires Not Available
DHCP Lease Obtained Not Available
MAC Address Not Available
Driver c:\windows\system32\drivers\rasl2tp.sys (5.2.3663.0
(main.020715-1506), 61.63 KB (63,104 bytes), 7/29/2002 1:50 PM)

Name [00000005] WAN Miniport (PPTP)
Adapter Type Wide Area Network (WAN)
Product Type WAN Miniport (PPTP)
Installed Yes
PNP Device ID ROOT\MS_PPTPMINIPOINT\0000
Last Reset 12/18/2002 12:15 PM
Index 5
Service Name PptpMiniport
IP Address Not Available
IP Subnet Not Available
Default IP Gateway Not Available
DHCP Enabled No
DHCP Server Not Available
DHCP Lease Expires Not Available
DHCP Lease Obtained Not Available
MAC Address 50:50:54:50:30:30
Driver c:\windows\system32\drivers\raspptp.sys (5.2.3663.0
(main.020715-1506), 56.00 KB (57,344 bytes), 7/29/2002 1:50 PM)

Name [00000006] WAN Miniport (PPPOE)
Adapter Type Wide Area Network (WAN)
Product Type WAN Miniport (PPPOE)
Installed Yes
PNP Device ID ROOT\MS_PPPOEMINIPOINT\0000
Last Reset 12/18/2002 12:15 PM
Index 6
Service Name RasPppoe
IP Address Not Available
IP Subnet Not Available
Default IP Gateway Not Available

Appendix C – Tunable Parameters

DHCP Enabled No
DHCP Server Not Available
DHCP Lease Expires Not Available
DHCP Lease Obtained Not Available
MAC Address 33:50:6F:45:30:30
Driver c:\windows\system32\drivers\rasppoe.sys (5.2.3663.0
(main.020715-1506), 36.88 KB (37,760 bytes), 7/29/2002 1:50 PM)

Name [00000007] Direct Parallel
Adapter Type Not Available
Product Type Direct Parallel
Installed Yes
PNP Device ID ROOT\MS_PTMINIPORT\0000
Last Reset 12/18/2002 12:15 PM
Index 7
Service Name Raspti
IP Address Not Available
IP Subnet Not Available
Default IP Gateway Not Available
DHCP Enabled No
DHCP Server Not Available
DHCP Lease Expires Not Available
DHCP Lease Obtained Not Available
MAC Address Not Available
Driver c:\windows\system32\drivers\raspti.sys (5.2.3663.0
(main.020715-1506), 16.38 KB (16,768 bytes), 7/29/2002 1:50 PM)

Name [00000008] WAN Miniport (IP)
Adapter Type Not Available
Product Type WAN Miniport (IP)
Installed Yes
PNP Device ID ROOT\MS_NDISWANIP\0000
Last Reset 12/18/2002 12:15 PM
Index 8
Service Name NdisWan
IP Address Not Available
IP Subnet Not Available
Default IP Gateway Not Available
DHCP Enabled No
DHCP Server Not Available
DHCP Lease Expires Not Available
DHCP Lease Obtained Not Available
MAC Address Not Available
Driver c:\windows\system32\drivers\ndiswan.sys (5.2.3663.0
(main.020715-1506), 87.13 KB (89,216 bytes), 7/29/2002 1:33 PM)

[Protocol]

Item Value
Name MSAFD Tcpip [TCP/IP]
Connectionless Service No
Guarantees Delivery Yes
Guarantees Sequencing Yes
Maximum Address Size 16 bytes
Maximum Message Size 0 bytes

Appendix C – Tunable Parameters

Message Oriented No
Minimum Address Size 16 bytes
Pseudo Stream Oriented No
Supports Broadcasting No
Supports Connect Data No
Supports Disconnect Data No
Supports Encryption No
Supports Expedited Data Yes
Supports Graceful Closing Yes
Supports Guaranteed Bandwidth No
Supports Multicasting No

Name MSAFD Tcpi [UDP/IP]
Connectionless Service Yes
Guarantees Delivery No
Guarantees Sequencing No
Maximum Address Size 16 bytes
Maximum Message Size 63.93 KB (65,467 bytes)
Message Oriented Yes
Minimum Address Size 16 bytes
Pseudo Stream Oriented No
Supports Broadcasting Yes
Supports Connect Data No
Supports Disconnect Data No
Supports Encryption No
Supports Expedited Data No
Supports Graceful Closing No
Supports Guaranteed Bandwidth No
Supports Multicasting Yes

Name RSVP UDP Service Provider
Connectionless Service Yes
Guarantees Delivery No
Guarantees Sequencing No
Maximum Address Size 16 bytes
Maximum Message Size 63.93 KB (65,467 bytes)
Message Oriented Yes
Minimum Address Size 16 bytes
Pseudo Stream Oriented No
Supports Broadcasting Yes
Supports Connect Data No
Supports Disconnect Data No
Supports Encryption Yes
Supports Expedited Data No
Supports Graceful Closing No
Supports Guaranteed Bandwidth No
Supports Multicasting Yes

Name RSVP TCP Service Provider
Connectionless Service No
Guarantees Delivery Yes
Guarantees Sequencing Yes
Maximum Address Size 16 bytes
Maximum Message Size 0 bytes
Message Oriented No

Appendix C – Tunable Parameters

Minimum Address Size 16 bytes
Pseudo Stream Oriented No
Supports Broadcasting No
Supports Connect Data No
Supports Disconnect Data No
Supports Encryption Yes
Supports Expedited Data Yes
Supports Graceful Closing Yes
Supports Guaranteed Bandwidth No
Supports Multicasting No

Name MSAFD NetBIOS [\Device\NetBT_Tcpip_{963EF834-1E2A-4884-B8E3-B2226A7028B5}] SEQPACKET 0

Connectionless Service No
Guarantees Delivery Yes
Guarantees Sequencing Yes
Maximum Address Size 20 bytes
Maximum Message Size 62.50 KB (64,000 bytes)
Message Oriented Yes
Minimum Address Size 20 bytes
Pseudo Stream Oriented No
Supports Broadcasting No
Supports Connect Data No
Supports Disconnect Data No
Supports Encryption No
Supports Expedited Data No
Supports Graceful Closing No
Supports Guaranteed Bandwidth No
Supports Multicasting No

Name MSAFD NetBIOS [\Device\NetBT_Tcpip_{963EF834-1E2A-4884-B8E3-B2226A7028B5}] DATAGRAM 0

Connectionless Service Yes
Guarantees Delivery No
Guarantees Sequencing No
Maximum Address Size 20 bytes
Maximum Message Size 62.50 KB (64,000 bytes)
Message Oriented Yes
Minimum Address Size 20 bytes
Pseudo Stream Oriented No
Supports Broadcasting Yes
Supports Connect Data No
Supports Disconnect Data No
Supports Encryption No
Supports Expedited Data No
Supports Graceful Closing No
Supports Guaranteed Bandwidth No
Supports Multicasting No

Name MSAFD NetBIOS [\Device\NetBT_Tcpip_{33BDC1FB-8870-42DA-851E-7365EA4D529F}] SEQPACKET 1

Connectionless Service No
Guarantees Delivery Yes
Guarantees Sequencing Yes
Maximum Address Size 20 bytes

Appendix C – Tunable Parameters

Maximum Message Size 62.50 KB (64,000 bytes)
Message Oriented Yes
Minimum Address Size 20 bytes
Pseudo Stream Oriented No
Supports Broadcasting No
Supports Connect Data No
Supports Disconnect Data No
Supports Encryption No
Supports Expedited Data No
Supports Graceful Closing No
Supports Guaranteed Bandwidth No
Supports Multicasting No

Name MSAFD NetBIOS [\Device\NetBT_Tcpip_{33BDC1FB-8870-42DA-851E-7365EA4D529F}] DATAGRAM 1
Connectionless Service Yes
Guarantees Delivery No
Guarantees Sequencing No
Maximum Address Size 20 bytes
Maximum Message Size 62.50 KB (64,000 bytes)
Message Oriented Yes
Minimum Address Size 20 bytes
Pseudo Stream Oriented No
Supports Broadcasting Yes
Supports Connect Data No
Supports Disconnect Data No
Supports Encryption No
Supports Expedited Data No
Supports Graceful Closing No
Supports Guaranteed Bandwidth No
Supports Multicasting No

Name MSAFD NetBIOS [\Device\NetBT_Tcpip_{ABF969CE-9BAB-42C9-8D9B-15A5DE0311BC}] SEQPACKET 2
Connectionless Service No
Guarantees Delivery Yes
Guarantees Sequencing Yes
Maximum Address Size 20 bytes
Maximum Message Size 62.50 KB (64,000 bytes)
Message Oriented Yes
Minimum Address Size 20 bytes
Pseudo Stream Oriented No
Supports Broadcasting No
Supports Connect Data No
Supports Disconnect Data No
Supports Encryption No
Supports Expedited Data No
Supports Graceful Closing No
Supports Guaranteed Bandwidth No
Supports Multicasting No

Name MSAFD NetBIOS [\Device\NetBT_Tcpip_{ABF969CE-9BAB-42C9-8D9B-15A5DE0311BC}] DATAGRAM 2
Connectionless Service Yes
Guarantees Delivery No

Appendix C – Tunable Parameters

Guarantees Sequencing No
Maximum Address Size 20 bytes
Maximum Message Size 62.50 KB (64,000 bytes)
Message Oriented Yes
Minimum Address Size 20 bytes
Pseudo Stream Oriented No
Supports Broadcasting Yes
Supports Connect Data No
Supports Disconnect Data No
Supports Encryption No
Supports Expedited Data No
Supports Graceful Closing No
Supports Guaranteed Bandwidth No
Supports Multicasting No

Name MSAFD NetBIOS [\Device\NetBT_Tcpip_{5AD13563-F9A5-4E16-9343-D0F5532E3E7D}] SEQPACKET 3
Connectionless Service No
Guarantees Delivery Yes
Guarantees Sequencing Yes
Maximum Address Size 20 bytes
Maximum Message Size 62.50 KB (64,000 bytes)
Message Oriented Yes
Minimum Address Size 20 bytes
Pseudo Stream Oriented No
Supports Broadcasting No
Supports Connect Data No
Supports Disconnect Data No
Supports Encryption No
Supports Expedited Data No
Supports Graceful Closing No
Supports Guaranteed Bandwidth No
Supports Multicasting No

Name MSAFD NetBIOS [\Device\NetBT_Tcpip_{5AD13563-F9A5-4E16-9343-D0F5532E3E7D}] DATAGRAM 3
Connectionless Service Yes
Guarantees Delivery No
Guarantees Sequencing No
Maximum Address Size 20 bytes
Maximum Message Size 62.50 KB (64,000 bytes)
Message Oriented Yes
Minimum Address Size 20 bytes
Pseudo Stream Oriented No
Supports Broadcasting Yes
Supports Connect Data No
Supports Disconnect Data No
Supports Encryption No
Supports Expedited Data No
Supports Graceful Closing No
Supports Guaranteed Bandwidth No
Supports Multicasting No

[WinSock]

Appendix C – Tunable Parameters

Item Value
File c:\windows\system32\winsock.dll
Size 2.80 KB (2,864 bytes)
Version 3.10

File c:\windows\system32\wsock32.dll
Size 22.00 KB (22,528 bytes)
Version 5.2.3663.0 (main.020715-1506)

[Ports]

[Serial]

Item Value
Name Communications Port (COM1)
Status OK
PNP Device ID ACPI\PNP0501\1
Maximum Input Buffer Size 0
Maximum Output Buffer Size No
Settable Baud Rate Yes
Settable Data Bits Yes
Settable Flow Control Yes
Settable Parity Yes
Settable Parity Check Yes
Settable Stop Bits Yes
Settable RLSD Yes
Supports RLSD Yes
Supports 16 Bit Mode No
Supports Special Characters No
Baud Rate 9600
Bits/Byte 8
Stop Bits 1
Parity None
Busy No
Abort Read/Write on Error No
Binary Mode Enabled Yes
Continue Xmit on XOff No
CTS Outflow Control No
Discard NULL Bytes No
DSR Outflow Control 0
DSR Sensitivity 0
DTR Flow Control Type Enable
EOF Character 0
Error Replace Character 0
Error Replacement Enabled No
Event Character 0
Parity Check Enabled No
RTS Flow Control Type Enable
XOff Character 19
XOffXmit Threshold 512
XOn Character 17
XOnXmit Threshold 2048
XOnXOff InFlow Control 0

Appendix C – Tunable Parameters

XOnXOff OutFlow Control 0
I/O Port 0x000003F8-0x000003FF
IRQ Channel IRQ 4
Driver c:\windows\system32\drivers\serial.sys (5.2.3663.0
(main.020715-1506), 61.63 KB (63,104 bytes), 7/29/2002 1:55 PM)

[Parallel]

Item Value

[Storage]

[Drives]

Item Value

Drive A:
Description 3 1/2 Inch Floppy Drive

Drive C:
Description Local Fixed Disk
Compressed No
File System NTFS
Size 8.46 GB (9,088,901,120 bytes)
Free Space 514.25 MB (539,226,112 bytes)
Volume Name
Volume Serial Number FC445CAC

Drive D:
Description Local Fixed Disk
Compressed No
File System NTFS
Size 16.94 GB (18,194,284,544 bytes)
Free Space 12.10 GB (12,991,582,208 bytes)
Volume Name
Volume Serial Number C4FA3D5D

Drive E:
Description Local Fixed Disk
Compressed Not Available
File System Not Available
Size Not Available
Free Space Not Available
Volume Name Not Available
Volume Serial Number Not Available

Drive F:
Description Local Fixed Disk
Compressed Not Available
File System Not Available
Size Not Available
Free Space Not Available
Volume Name Not Available
Volume Serial Number Not Available

Appendix C – Tunable Parameters

Drive G:
Description Local Fixed Disk
Compressed Not Available
File System Not Available
Size Not Available
Free Space Not Available
Volume Name Not Available
Volume Serial Number Not Available

Drive H:
Description Local Fixed Disk
Compressed Not Available
File System Not Available
Size Not Available
Free Space Not Available
Volume Name Not Available
Volume Serial Number Not Available

Drive I:
Description Local Fixed Disk
Compressed Not Available
File System Not Available
Size Not Available
Free Space Not Available
Volume Name Not Available
Volume Serial Number Not Available

Drive J:
Description Local Fixed Disk
Compressed Not Available
File System Not Available
Size Not Available
Free Space Not Available
Volume Name Not Available
Volume Serial Number Not Available

Drive K:
Description Local Fixed Disk
Compressed Not Available
File System Not Available
Size Not Available
Free Space Not Available
Volume Name Not Available
Volume Serial Number Not Available

Drive L:
Description Local Fixed Disk
Compressed Not Available
File System Not Available
Size Not Available
Free Space Not Available
Volume Name Not Available
Volume Serial Number Not Available

Appendix C – Tunable Parameters

Drive M:
Description Local Fixed Disk
Compressed Not Available
File System Not Available
Size Not Available
Free Space Not Available
Volume Name Not Available
Volume Serial Number Not Available

Drive N:
Description Local Fixed Disk
Compressed Not Available
File System Not Available
Size Not Available
Free Space Not Available
Volume Name Not Available
Volume Serial Number Not Available

Drive O:
Description Local Fixed Disk
Compressed No
File System NTFS
Size 8.49 GB (9,113,608,192 bytes)
Free Space 7.70 GB (8,263,876,608 bytes)
Volume Name
Volume Serial Number 4860A558

Drive P:
Description CD-ROM Disc

Drive S:
Description Local Fixed Disk
Compressed Not Available
File System Not Available
Size Not Available
Free Space Not Available
Volume Name Not Available
Volume Serial Number Not Available

Drive V:
Description Local Fixed Disk
Compressed No
File System NTFS
Size 292.97 GB (314,575,831,040 bytes)
Free Space 110.06 GB (118,171,144,192 bytes)
Volume Name
Volume Serial Number C4277575

Drive W:
Description Local Fixed Disk
Compressed No
File System NTFS
Size 292.97 GB (314,575,831,040 bytes)
Free Space 110.06 GB (118,171,078,656 bytes)
Volume Name

Appendix C – Tunable Parameters

Volume Serial Number F847BFA4

Drive X:

Description Local Fixed Disk
Compressed No
File System NTFS
Size 292.97 GB (314,575,831,040 bytes)
Free Space 110.06 GB (118,171,209,728 bytes)
Volume Name
Volume Serial Number 983BB003

Drive Y:

Description Local Fixed Disk
Compressed No
File System NTFS
Size 292.97 GB (314,575,831,040 bytes)
Free Space 110.06 GB (118,171,209,728 bytes)
Volume Name
Volume Serial Number E8564BAC

Drive Z:

Description Local Fixed Disk
Compressed No
File System NTFS
Size 292.97 GB (314,575,831,040 bytes)
Free Space 110.06 GB (118,171,209,728 bytes)
Volume Name
Volume Serial Number 8064B639

[Disks]

Item Value

Description \\.\PHYSICALDRIVE4
Manufacturer Not Available
Model Not Available
Bytes/Sector 512
Media Loaded Yes
Media Type Fixed hard disk
Partitions 3
SCSI Bus 4
SCSI Logical Unit 0
SCSI Port 5
SCSI Target ID 0
Sectors/Track 63
Size 938.44 GB (1,007,637,926,400 bytes)
Total Cylinders 122,505
Total Sectors 1,968,042,825
Total Tracks 31,238,775
Tracks/Cylinder 255
Partition Disk #4, Partition #0
Partition Size 151.03 GB (162,169,588,224 bytes)
Partition Starting Offset 32,256 bytes
Partition Disk #4, Partition #1
Partition Size 83.63 GB (89,795,381,760 bytes)
Partition Starting Offset 162,169,620,480 bytes

Appendix C – Tunable Parameters

Partition Disk #4, Partition #2
Partition Size 292.97 GB (314,575,833,600 bytes)
Partition Starting Offset 251,965,002,240 bytes

Description \\.\PHYSICALDRIVE0
Manufacturer Not Available
Model Not Available
Bytes/Sector 512
Media Loaded Yes
Media Type Fixed hard disk
Partitions 1
SCSI Bus 4
SCSI Logical Unit 0
SCSI Port 1
SCSI Target ID 0
Sectors/Track 63
Size 406.77 GB (436,770,593,280 bytes)
Total Cylinders 53,101
Total Sectors 853,067,565
Total Tracks 13,540,755
Tracks/Cylinder 255
Partition Disk #0, Partition #0
Partition Size 406.77 GB (436,770,561,024 bytes)
Partition Starting Offset 32,256 bytes

Description \\.\PHYSICALDRIVE1
Manufacturer Not Available
Model Not Available
Bytes/Sector 512
Media Loaded Yes
Media Type Fixed hard disk
Partitions 3
SCSI Bus 4
SCSI Logical Unit 0
SCSI Port 2
SCSI Target ID 0
Sectors/Track 63
Size 938.44 GB (1,007,637,926,400 bytes)
Total Cylinders 122,505
Total Sectors 1,968,042,825
Total Tracks 31,238,775
Tracks/Cylinder 255
Partition Disk #1, Partition #0
Partition Size 151.03 GB (162,169,588,224 bytes)
Partition Starting Offset 32,256 bytes
Partition Disk #1, Partition #1
Partition Size 83.63 GB (89,795,381,760 bytes)
Partition Starting Offset 162,169,620,480 bytes
Partition Disk #1, Partition #2
Partition Size 292.97 GB (314,575,833,600 bytes)
Partition Starting Offset 251,965,002,240 bytes

Description \\.\PHYSICALDRIVE5
Manufacturer Not Available
Model Not Available

Appendix C – Tunable Parameters

Bytes/Sector 512
Media Loaded Yes
Media Type Fixed hard disk
Partitions 3
SCSI Bus 4
SCSI Logical Unit 0
SCSI Port 6
SCSI Target ID 0
Sectors/Track 63
Size 938.44 GB (1,007,637,926,400 bytes)
Total Cylinders 122,505
Total Sectors 1,968,042,825
Total Tracks 31,238,775
Tracks/Cylinder 255
Partition Disk #5, Partition #0
Partition Size 151.03 GB (162,169,588,224 bytes)
Partition Starting Offset 32,256 bytes
Partition Disk #5, Partition #1
Partition Size 83.63 GB (89,795,381,760 bytes)
Partition Starting Offset 162,169,620,480 bytes
Partition Disk #5, Partition #2
Partition Size 292.97 GB (314,575,833,600 bytes)
Partition Starting Offset 251,965,002,240 bytes

Description \\.\PHYSICALDRIVE2
Manufacturer Not Available
Model Not Available
Bytes/Sector 512
Media Loaded Yes
Media Type Fixed hard disk
Partitions 3
SCSI Bus 4
SCSI Logical Unit 0
SCSI Port 3
SCSI Target ID 0
Sectors/Track 63
Size 938.44 GB (1,007,637,926,400 bytes)
Total Cylinders 122,505
Total Sectors 1,968,042,825
Total Tracks 31,238,775
Tracks/Cylinder 255
Partition Disk #2, Partition #0
Partition Size 151.03 GB (162,169,588,224 bytes)
Partition Starting Offset 32,256 bytes
Partition Disk #2, Partition #1
Partition Size 83.63 GB (89,795,381,760 bytes)
Partition Starting Offset 162,169,620,480 bytes
Partition Disk #2, Partition #2
Partition Size 292.97 GB (314,575,833,600 bytes)
Partition Starting Offset 251,965,002,240 bytes

Description \\.\PHYSICALDRIVE3
Manufacturer Not Available
Model Not Available
Bytes/Sector 512

Appendix C – Tunable Parameters

Media Loaded Yes
Media Type Fixed hard disk
Partitions 3
SCSI Bus 4
SCSI Logical Unit 0
SCSI Port 4
SCSI Target ID 0
Sectors/Track 63
Size 938.44 GB (1,007,637,926,400 bytes)
Total Cylinders 122,505
Total Sectors 1,968,042,825
Total Tracks 31,238,775
Tracks/Cylinder 255
Partition Disk #3, Partition #0
Partition Size 151.03 GB (162,169,588,224 bytes)
Partition Starting Offset 32,256 bytes
Partition Disk #3, Partition #1
Partition Size 83.63 GB (89,795,381,760 bytes)
Partition Starting Offset 162,169,620,480 bytes
Partition Disk #3, Partition #2
Partition Size 292.97 GB (314,575,833,600 bytes)
Partition Starting Offset 251,965,002,240 bytes

Description Disk drive
Manufacturer (Standard disk drives)
Model SEAGATE ST318305LC SCSI Disk Device
Bytes/Sector 512
Media Loaded Yes
Media Type Fixed hard disk
Partitions 1
SCSI Bus 0
SCSI Logical Unit 0
SCSI Port 7
SCSI Target ID 1
Sectors/Track 63
Size 16.95 GB (18,202,544,640 bytes)
Total Cylinders 2,213
Total Sectors 35,551,845
Total Tracks 564,315
Tracks/Cylinder 255
Partition Disk #7, Partition #0
Partition Size 16.94 GB (18,194,287,104 bytes)
Partition Starting Offset 32,256 bytes

Description Disk drive
Manufacturer (Standard disk drives)
Model SEAGATE ST318406LC SCSI Disk Device
Bytes/Sector 512
Media Loaded Yes
Media Type Fixed hard disk
Partitions 2
SCSI Bus 0
SCSI Logical Unit 0
SCSI Port 7
SCSI Target ID 0

Appendix C – Tunable Parameters

Sectors/Track 63
Size 16.95 GB (18,202,544,640 bytes)
Total Cylinders 2,213
Total Sectors 35,551,845
Total Tracks 564,315
Tracks/Cylinder 255
Partition Disk #6, Partition #0
Partition Size 8.46 GB (9,088,902,144 bytes)
Partition Starting Offset 32,256 bytes
Partition Disk #6, Partition #1
Partition Size 8.49 GB (9,113,610,240 bytes)
Partition Starting Offset 9,088,934,400 bytes

[SCSI]

Item Value

Name Adaptec AIC-7892 Ultra160 PCI SCSI Card
Manufacturer Adaptec
Status OK
PNP Device ID
PCI\VEN_9005&DEV_008F&SUBSYS_01091028&REV_02\3&13C0B0C5&0&18
I/O Port 0x0000EC00-0x0000ECFF
Memory Address 0xFE101000-0xFE101FFF
IRQ Channel IRQ 16
Driver c:\windows\system32\drivers\adpu160m.sys (RTC_XP07
(lab01_n(storbuild).010917-1031), 99.63 KB (102,016 bytes), 12/4/2002
4:56 PM)

Name Mylex eXtremeRAID 2000 Disk Array Controller (Accelerated)
Manufacturer Mylex
Status OK
PNP Device ID
PCI\VEN_1069&DEV_BA56&SUBSYS_00401069&REV_00\4&235BDD1F&0&4008
Memory Address 0xFB800000-0xFC7FFFFFFF
I/O Port 0x0000DC80-0x0000DCFF
Memory Address 0xF4000000-0xFC8FFFFFFF
IRQ Channel IRQ 21
Driver c:\windows\system32\drivers\dac2w2k.sys (7.00-14 built by:
WinDDK, 172.75 KB (176,896 bytes), 9/9/2002 1:46 PM)

Name Mylex eXtremeRAID 2000 Disk Array Controller (Accelerated)
Manufacturer Mylex
Status OK
PNP Device ID
PCI\VEN_1069&DEV_BA56&SUBSYS_00401069&REV_00\4&2AAB4416&0&4008
Memory Address 0xF2800000-0xF37FFFFFFF
I/O Port 0x0000BC80-0x0000BCFF
Memory Address 0xF2000000-0xF38FFFFFFF
IRQ Channel IRQ 25
Driver c:\windows\system32\drivers\dac2w2k.sys (7.00-14 built by:
WinDDK, 172.75 KB (176,896 bytes), 9/9/2002 1:46 PM)

Name Mylex eXtremeRAID 2000 Disk Array Controller (Accelerated)
Manufacturer Mylex
Status OK

Appendix C – Tunable Parameters

PNP Device ID

PCI\VEN_1069&DEV_BA56&SUBSYS_00401069&REV_00\4&18212E42&0&4008
Memory Address 0xF0800000-0xF17FFFFFFF
I/O Port 0x0000AC80-0x0000ACFF
Memory Address 0xF0000000-0xF18FFFFFFF
IRQ Channel IRQ 23
Driver c:\windows\system32\drivers\dac2w2k.sys (7.00-14 built by:
WinDDK, 172.75 KB (176,896 bytes), 9/9/2002 1:46 PM)

Name Mylex eXtremeRAID 2000 Disk Array Controller (Accelerated)

Manufacturer Mylex

Status OK

PNP Device ID

PCI\VEN_1069&DEV_BA56&SUBSYS_00401069&REV_00\4&18595B4B&0&4010
Memory Address 0xEE800000-0xEF7FFFFFFF
I/O Port 0x00009C80-0x00009CFF
Memory Address 0xE8000000-0xEF8FFFFFFF
IRQ Channel IRQ 30
Driver c:\windows\system32\drivers\dac2w2k.sys (7.00-14 built by:
WinDDK, 172.75 KB (176,896 bytes), 9/9/2002 1:46 PM)

Name Mylex eXtremeRAID 2000 Disk Array Controller (Accelerated)

Manufacturer Mylex

Status OK

PNP Device ID

PCI\VEN_1069&DEV_BA56&SUBSYS_00401069&REV_00\4&13747BCE&0&4008
Memory Address 0xE6800000-0xE77FFFFFFF
I/O Port 0x00008C80-0x00008CFF
Memory Address 0xE0000000-0xE3FFFFFFF
IRQ Channel IRQ 27
Driver c:\windows\system32\drivers\dac2w2k.sys (7.00-14 built by:
WinDDK, 172.75 KB (176,896 bytes), 9/9/2002 1:46 PM)

Name Mylex eXtremeRAID 2000 Disk Array Controller (Accelerated)

Manufacturer Mylex

Status OK

PNP Device ID

PCI\VEN_1069&DEV_BA56&SUBSYS_00401069&REV_00\4&30064324&0&4010
Memory Address 0xE5800000-0xE67FFFFFFF
I/O Port 0x00007C80-0x00007CFF
Memory Address 0xDC000000-0xE78FFFFFFF
IRQ Channel IRQ 28
Driver c:\windows\system32\drivers\dac2w2k.sys (7.00-14 built by:
WinDDK, 172.75 KB (176,896 bytes), 9/9/2002 1:46 PM)

[IDE]

Item Value

Name Standard Dual Channel PCI IDE Controller

Manufacturer (Standard IDE ATA/ATAPI controllers)

Status OK

PNP Device ID

PCI\VEN_1166&DEV_0212&SUBSYS_02121166&REV_93\3&13C0B0C5&0&79
I/O Port 0x000008B0-0x000008BF

Appendix C – Tunable Parameters

Driver c:\windows\system32\drivers\pciide.sys (5.2.3663.0
(main.020715-1506), 3.50 KB (3,584 bytes), 7/29/2002 1:49 PM)

Name Primary IDE Channel

Manufacturer (Standard IDE ATA/ATAPI controllers)

Status OK

PNP Device ID PCIIDE\IDECHANNEL\4&10A8249&0&0

I/O Port 0x000001F0-0x000001F7

I/O Port 0x000003F6-0x000003F6

IRQ Channel IRQ 14

Driver c:\windows\system32\drivers\atapi.sys (5.2.3663.0
(main.020715-1506), 90.38 KB (92,544 bytes), 7/29/2002 1:09 PM)

Name Secondary IDE Channel

Manufacturer (Standard IDE ATA/ATAPI controllers)

Status Error

PNP Device ID PCIIDE\IDECHANNEL\4&10A8249&0&1

I/O Port 0x00000170-0x00000177

I/O Port 0x00000376-0x00000376

IRQ Channel IRQ 15

Driver c:\windows\system32\drivers\atapi.sys (5.2.3663.0
(main.020715-1506), 90.38 KB (92,544 bytes), 7/29/2002 1:09 PM)

[Printing]

Name	Driver	Port Name	Server Name
------	--------	-----------	-------------

[Problem Devices]

Device	PNP Device ID	Error Code	
Secondary IDE Channel	PCIIDE\IDECHANNEL\4&10A8249&0&1		This device cannot find enough free resources that it can use.

[USB]

Device	PNP Device ID
--------	---------------

System Information report written at: 12/19/02 11:25:29

System Name: PE6500

[Software Environment]

[System Drivers]

Name	Description	File	Type	Started	Start Mode	State	Status
	Error Control		Accept	Pause	Accept	Stop	
abiosdsk	Abiosdsk		Not Available		Kernel Driver		No
	Disabled	Stopped	OK	Ignore	No	No	
acpi	Microsoft ACPI Driver		Kernel Driver	Yes	c:\windows\system32\drivers\acpi.sys	Boot Running	OK Normal No
	Yes						
acpiec	ACPIEC		Kernel Driver	No	c:\windows\system32\drivers\acpiec.sys	Disabled Stopped	OK Normal
	No	No					

Appendix C – Tunable Parameters

adpu160m	adpu160m	c:\windows\system32\drivers\adpu160m.sys						
	Kernel Driver	Yes	Boot	Running	OK	Normal		No
	Yes							
adpu320	adpu320	Not Available			Kernel Driver			No
	Disabled	Stopped	OK	Normal	No	No		
afcnc	afcnc	Not Available			Kernel Driver	No	Disabled	
	Stopped	OK	Normal	No	No			
afd	AFD Networking Support Environment							
	c:\windows\system32\drivers\afd.sys	Kernel Driver				Yes		Auto
	Running	OK	Normal	No	Yes			
aha154x	Aha154x	Not Available			Kernel Driver			No
	Disabled	Stopped	OK	Normal	No	No		
aic78u2	aic78u2	Not Available			Kernel Driver			No
	Disabled	Stopped	OK	Normal	No	No		
aic78xx	aic78xx	Not Available			Kernel Driver			No
	Disabled	Stopped	OK	Normal	No	No		
aliide	AliIde	Not Available			Kernel Driver			No
	Disabled	Stopped	OK	Normal	No	No		
asynctac	RAS Asynchronous Media Driver							
	c:\windows\system32\drivers\asynctac.sys	Kernel Driver						No
	Manual	Stopped	OK	Normal	No	No		
ataapi	Standard IDE/ESDI Hard Disk Controller							
	c:\windows\system32\drivers\ataapi.sys	Kernel Driver						Yes
	Boot	Running	OK	Normal	No	Yes		
atdisk	Atdisk	Not Available			Kernel Driver			No
	Disabled	Stopped	OK	Ignore	No	No		
ati2mpad	ati2mpad	c:\windows\system32\drivers\ati2mpad.sys						
	Kernel Driver	Yes	Manual	Running	OK	Ignore		
	No	Yes						
atmarpc	ATM ARP Client Protocol							
	c:\windows\system32\drivers\atmarpc.sys	Kernel Driver						No
	Manual	Stopped	OK	Normal	No	No		
audstub	Audio Stub Driver c:\windows\system32\drivers\audstub.sys							
	Kernel Driver	Yes	Manual	Running	OK	Normal		
	No	Yes						
b57w2k	Broadcom NetXtreme Gigabit Ethernet							
	c:\windows\system32\drivers\b57xp32.sys	Kernel Driver						Yes
	Manual	Running	OK	Normal	No	Yes		
beep	Beep	c:\windows\system32\drivers\beep.sys						
	Yes	System	Running	OK	Normal	No	Yes	
cbidf2k	cbidf2k	c:\windows\system32\drivers\cbidf2k.sys						
	Kernel Driver	No	Disabled	Stopped	OK	Normal		
	No	No						
cd20xrnt	cd20xrnt	Not Available			Kernel Driver			No
	Disabled	Stopped	OK	Normal	No	No		
cdfs	Cdfs	c:\windows\system32\drivers\cdfs.sys						
Driver	Yes	Disabled	Running	OK	Normal	No	Yes	
cdrom	CD-ROM Driver c:\windows\system32\drivers\cdrom.sys							
	Kernel Driver	Yes	System	Running	OK	Normal		
	No	Yes						
changer	Changer	Not Available			Kernel Driver			No
	System	Stopped	OK	Ignore	No	No		
clusdisk	Cluster Disk Driver							
	c:\windows\system32\drivers\clusdisk.sys	Kernel Driver						No
	Disabled	Stopped	OK	Normal	No	No		

Appendix C – Tunable Parameters

cmdide	CmdIde	Not Available	Kernel Driver	No				
	Disabled	Stopped	OK	Normal	No	No		
cpqarray	Cpqarray	Not Available	Kernel Driver	No				
	Disabled	Stopped	OK	Normal	No	No		
cpqarray2	cpqarray2	Not Available	Kernel Driver	No				
	Disabled	Stopped	OK	Normal	No	No		
cpqcissm	cpqcissm	Not Available	Kernel Driver	No				
	Disabled	Stopped	OK	Normal	No	No		
cpqfcalm	cpqfcalm	Not Available	Kernel Driver	No				
	Disabled	Stopped	OK	Normal	No	No		
crcdisk	CRC Disk Filter Driver							
	c:\windows\system32\drivers\crcdisk.sys		Kernel Driver	Yes				
	Boot	Running	OK	Normal	No	Yes		
dac2w2k	dac2w2k	c:\windows\system32\drivers\dac2w2k.sys						
	Kernel Driver	Yes	Boot	Running	OK	Normal	No	
	Yes							
dac960nt	dac960nt	Not Available	Kernel Driver	No				
	Disabled	Stopped	OK	Normal	No	No		
dfsdriver	DfsDriver	c:\windows\system32\drivers\dfs.sys					File System	
Driver	Yes	Boot	Running	OK	Normal	No	Yes	
disk	Disk Driver	c:\windows\system32\drivers\disk.sys					Kernel	
Driver	Yes	Boot	Running	OK	Normal	No	Yes	
dmboot	dmboot	c:\windows\system32\drivers\dmboot.sys						
	Kernel Driver	No	Disabled	Stopped	OK	Normal		
	No	No						
dmio	Logical Disk Manager Driver							
	c:\windows\system32\drivers\dmio.sys		Kernel Driver	Yes				
	Boot	Running	OK	Normal	No	Yes		
dmload	dmload	c:\windows\system32\drivers\dmload.sys						
	Kernel Driver	Yes	Boot	Running	OK	Normal	No	
	Yes							
dpti2o	dpti2o	Not Available	Kernel Driver	No				
	Disabled	Stopped	OK	Normal	No	No		
fastfat	Fastfat	c:\windows\system32\drivers\fastfat.sys					File	
System Driver	Yes	Disabled	Running	OK	Normal	No	No	
	Yes							
fdc	Floppy Disk Controller Driver c:\windows\system32\drivers\fdc.sys							
	Kernel Driver	Yes	Manual	Running	OK	Normal		
	No	Yes						
fips	Fips	c:\windows\system32\drivers\fips.sys					Kernel Driver	
	Yes	System	Running	OK	Normal	No	Yes	
flpydisk	Floppy Disk Driver							
	c:\windows\system32\drivers\flpydisk.sys		Kernel Driver	Yes				
	Manual	Running	OK	Normal	No	Yes		
ftdisk	Volume Manager Driver							
	c:\windows\system32\drivers\ftdisk.sys		Kernel Driver	Yes				
	Boot	Running	OK	Normal	No	Yes		
gpc	Generic Packet Classifier							
	c:\windows\system32\drivers\msgpc.sys		Kernel Driver	Yes				
	Manual	Running	OK	Normal	No	Yes		
hpn	hpn	Not Available	Kernel Driver	No	Disabled			
	Stopped	OK	Normal	No	No			
hpt3xx	hpt3xx	Not Available	Kernel Driver	No				
	Disabled	Stopped	OK	Normal	No	No		

Appendix C – Tunable Parameters

http	HTTP	c:\windows\system32\drivers\http.sys	Kernel Driver					
	No	Manual	Stopped	OK	Normal	No	No	
i2omgmt	i2omgmt	Not Available	Kernel Driver			No	No	
	System	Stopped	OK	Normal		No	No	
i2omp	i2omp	Not Available	Kernel Driver			No	Disabled	
	Stopped	OK	Normal		No	No		
i8042prt	i8042	Keyboard and PS/2 Mouse Port Driver						
		c:\windows\system32\drivers\i8042prt.sys	Kernel Driver			No	Yes	Yes
	System	Running	OK	Normal		No	Yes	
imapi	CD-Burning Filter Driver							
		c:\windows\system32\drivers\imapi.sys	Kernel Driver			No	No	No
	System	Stopped	OK	Normal		No	No	
intelide	IntelIde	Not Available	Kernel Driver			No	No	No
	Disabled	Stopped	OK	Normal		No	No	
ipfilterdriver	IP Traffic Filter Driver							
		c:\windows\system32\drivers\ipfltdrv.sys	Kernel Driver			No	No	No
	Manual	Stopped	OK	Normal		No	No	
ipinip	IP in IP Tunnel Driver							
		c:\windows\system32\drivers\ipinip.sys	Kernel Driver			No	No	No
	Manual	Stopped	OK	Normal		No	No	
ipnat	IP Network Address Translator							
		c:\windows\system32\drivers\ipnat.sys	Kernel Driver			No	No	No
	Manual	Stopped	OK	Normal		No	No	
ipsec	IPSEC driver	c:\windows\system32\drivers\ipsec.sys						
	Kernel Driver	Yes	System	Running	OK	Normal		
	No	Yes						
ipsraidn	ipsraidn	Not Available	Kernel Driver			No	No	No
	Disabled	Stopped	OK	Normal		No	No	
isapnp	PnP ISA/EISA Bus Driver							
		c:\windows\system32\drivers\isapnp.sys	Kernel Driver			No	Yes	Yes
	Boot	Running	OK	Critical	No	Yes		
kbdclass	Keyboard Class Driver							
		c:\windows\system32\drivers\kbdclass.sys	Kernel Driver			No	Yes	Yes
	System	Running	OK	Normal		No	Yes	
ksecdd	KSecDD	c:\windows\system32\drivers\ksecdd.sys						
	Kernel Driver	Yes	Boot	Running	OK	Normal		No
	Yes							
lp6nds35	lp6nds35	Not Available	Kernel Driver			No	No	No
	Disabled	Stopped	OK	Normal		No	No	
macxp32	macxp32	c:\windows\system32\drivers\macxp32.sys						
	Kernel Driver	Yes	Boot	Running	OK	Normal		No
	Yes							
mnmdd	mnmdd	c:\windows\system32\drivers\mnmdd.sys	Kernel Driver					
	Yes	System	Running	OK	Ignore	No	Yes	
modem	Modem	c:\windows\system32\drivers\modem.sys	Kernel Driver					
	No	Manual	Stopped	OK	Ignore	No	No	
mouclass	Mouse Class Driver							
		c:\windows\system32\drivers\mouclass.sys	Kernel Driver			No	Yes	Yes
	System	Running	OK	Normal		No	Yes	
mountmgr	Mount Point Manager							
		c:\windows\system32\drivers\mountmgr.sys	Kernel Driver			No	Yes	Yes
	Boot	Running	OK	Normal		No	Yes	
mraid35x	mraid35x	Not Available	Kernel Driver			No	No	No
	Disabled	Stopped	OK	Normal		No	No	

Appendix C – Tunable Parameters

```

mrxdav      WebDav Client Redirector
             c:\windows\system32\drivers\mrxdav.sys      File System Driver
             No   Manual      Stopped      OK   Normal      No   No
mrxsmb      MRXSMB      c:\windows\system32\drivers\mrxsmb.sys      File
System Driver      Yes   System      Running      OK   Normal      No
             Yes
msfs        Msfs      c:\windows\system32\drivers\msfs.sys      File System
Driver      Yes   System      Running      OK   Normal      No   Yes
mup         Mup      c:\windows\system32\drivers\mup.sys      File System Driver
             Yes   Boot      Running      OK   Normal      No   Yes
ndis        NDIS System Driver      c:\windows\system32\drivers\ndis.sys
Kernel Driver      Yes   Boot      Running      OK   Normal      No
             Yes
ndistapi    Remote Access NDIS TAPI Driver
             c:\windows\system32\drivers\ndistapi.sys      Kernel Driver      Yes
             Manual      Running      OK   Normal      No   Yes
ndisuio     NDIS Usermode I/O Protocol
             c:\windows\system32\drivers\ndisuio.sys      Kernel Driver      No
             Manual      Stopped      OK   Normal      No   No
ndiswan     Remote Access NDIS WAN Driver
             c:\windows\system32\drivers\ndiswan.sys      Kernel Driver      Yes
             Manual      Running      OK   Normal      No   Yes
ndproxy     NDIS Proxy      c:\windows\system32\drivers\ndproxy.sys
Kernel Driver      Yes   Manual      Running      OK   Normal
             No   Yes
netbios     NetBIOS Interface      c:\windows\system32\drivers\netbios.sys
File System Driver      Yes   System      Running      OK
             Normal      No   Yes
netbt       NetBios over Tcpip      c:\windows\system32\drivers\netbt.sys
Kernel Driver      Yes   System      Running      OK   Normal
             No   Yes
nfrd960     nfrd960      Not Available      Kernel Driver      No
             Disabled      Stopped      OK   Normal      No   No
npfs        Npfs      c:\windows\system32\drivers\npfs.sys      File System
Driver      Yes   System      Running      OK   Normal      No   Yes
ntfs        Ntfs      c:\windows\system32\drivers\ntfs.sys      File System
Driver      Yes   Disabled      Running      OK   Normal      No   Yes
null        Null      c:\windows\system32\drivers\null.sys      Kernel Driver
             Yes   System      Running      OK   Normal      No   Yes
parport     Parport      c:\windows\system32\drivers\parport.sys
Kernel Driver      No   Manual      Stopped      OK   Ignore
             No   No
partmgr     Partition Manager      c:\windows\system32\drivers\partmgr.sys
Kernel Driver      Yes   Boot      Running      OK   Normal      No
             Yes
parvdm      ParVdm      c:\windows\system32\drivers\parvdm.sys
Kernel Driver      No   Auto      Stopped      OK   Ignore      No
             No
pci         PCI Bus Driver      c:\windows\system32\drivers\pci.sys      Kernel
Driver      Yes   Boot      Running      OK   Critical      No   Yes
pciide      PCIIde      c:\windows\system32\drivers\pciide.sys
Kernel Driver      Yes   Boot      Running      OK   Normal      No
             Yes

```

Appendix C – Tunable Parameters

```

pcmcia      Pcmcia      c:\windows\system32\drivers\pcmcia.sys
  Kernel Driver  No   Disabled  Stopped  OK   Normal
  No   No
pdcomp      PDCOMP      Not Available  Kernel Driver  No
  Manual  Stopped  OK   Ignore   No   No
pdframe     PDFFRAME    Not Available  Kernel Driver  No
  Manual  Stopped  OK   Ignore   No   No
pdreli      PDRELI      Not Available  Kernel Driver  No
  Manual  Stopped  OK   Ignore   No   No
pdrframe    PDRFRAME    Not Available  Kernel Driver  No
  Manual  Stopped  OK   Ignore   No   No
perc2       perc2       Not Available  Kernel Driver  No   Disabled
  Stopped  OK   Normal   No   No
perc2hib    perc2hib    Not Available  Kernel Driver  No
  Disabled  Stopped  OK   Normal   No   No
pptpminiport  WAN Miniport (PPTP)
  c:\windows\system32\drivers\raspptp.sys  Kernel Driver  Yes
  Manual  Running  OK   Normal   No   Yes
processor   Processor Driver  c:\windows\system32\drivers\processr.sys
  Kernel Driver  Yes  Manual  Running  OK   Normal
  No   Yes
ptilink     Direct Parallel Link Driver
  c:\windows\system32\drivers\ptilink.sys  Kernel Driver  Yes
  Manual  Running  OK   Normal   No   Yes
ql1080      ql1080      Not Available  Kernel Driver  No
  Disabled  Stopped  OK   Normal   No   No
ql10wnt     Ql10wnt     Not Available  Kernel Driver  No
  Disabled  Stopped  OK   Normal   No   No
ql12160     ql12160     Not Available  Kernel Driver  No
  Disabled  Stopped  OK   Normal   No   No
ql1240      ql1240      Not Available  Kernel Driver  No
  Disabled  Stopped  OK   Normal   No   No
ql1280      ql1280      Not Available  Kernel Driver  No
  Disabled  Stopped  OK   Normal   No   No
ql2100      ql2100      Not Available  Kernel Driver  No
  Disabled  Stopped  OK   Normal   No   No
ql2200      ql2200      Not Available  Kernel Driver  No
  Disabled  Stopped  OK   Normal   No   No
ql2300      ql2300      Not Available  Kernel Driver  No
  Disabled  Stopped  OK   Normal   No   No
rasacd      Remote Access Auto Connection Driver
  c:\windows\system32\drivers\rasacd.sys  Kernel Driver  Yes
  System  Running  OK   Normal   No   Yes
rasl2tp     WAN Miniport (L2TP)
  c:\windows\system32\drivers\rasl2tp.sys  Kernel Driver  Yes
  Manual  Running  OK   Normal   No   Yes
rasppoe     Remote Access PPPOE Driver
  c:\windows\system32\drivers\rasppoe.sys  Kernel Driver  Yes
  Manual  Running  OK   Normal   No   Yes
raspti      Direct Parallel  c:\windows\system32\drivers\raspti.sys
  Kernel Driver  Yes  Manual  Running  OK   Normal
  No   Yes
rdbss       Rdbss       c:\windows\system32\drivers\rdbss.sys  File System
  Driver  Yes  System  Running  OK   Normal   No   Yes

```

Appendix C – Tunable Parameters

rdpcdd	RDPDCCD	c:\windows\system32\drivers\rdpcdd.sys					
	Kernel Driver	Yes	System	Running	OK	Ignore	
	No	Yes					
rdpdr	Terminal Server Device Redirector Driver						
		c:\windows\system32\drivers\rdpdr.sys			Kernel Driver		Yes
	Manual	Running	OK	Normal	No	Yes	
rdpwd	RDPWD	c:\windows\system32\drivers\rdpwd.sys			Kernel Driver		
	No	Manual	Stopped	OK	Ignore	No	No
redbook	Digital CD Audio Playback Filter Driver						
		c:\windows\system32\drivers\redbook.sys			Kernel Driver		Yes
	System	Running	OK	Normal	No	Yes	
secdrv	Secdrv	c:\windows\system32\drivers\secdrv.sys					
	Kernel Driver	No	Manual	Stopped	OK	Normal	
	No	No					
serenum	Serenum Filter Driver						
		c:\windows\system32\drivers\serenum.sys			Kernel Driver		Yes
	Manual	Running	OK	Normal	No	Yes	
serial	Serial port driver						
		c:\windows\system32\drivers\serial.sys			Kernel Driver		Yes
	System	Running	OK	Ignore	No	Yes	
sfloppy	Sfloppy	c:\windows\system32\drivers\sfloppy.sys					
	Kernel Driver	No	System	Stopped	OK	Ignore	
	No	No					
simbad	Simbad	Not Available			Kernel Driver		No
	Disabled	Stopped	OK	Normal	No	No	
sparrow	Sparrow	Not Available			Kernel Driver		No
	Disabled	Stopped	OK	Normal	No	No	
srv	Srv	c:\windows\system32\drivers\srv.sys			File System Driver		
	Yes	Manual	Running	OK	Normal	No	Yes
swenum	Software Bus Driver						
		c:\windows\system32\drivers\swenum.sys			Kernel Driver		Yes
	Manual	Running	OK	Normal	No	Yes	
symc810	symc810	Not Available			Kernel Driver		No
	Disabled	Stopped	OK	Normal	No	No	
symc8xx	symc8xx	Not Available			Kernel Driver		No
	Disabled	Stopped	OK	Normal	No	No	
symmpi	symmpi	Not Available			Kernel Driver		No
	Disabled	Stopped	OK	Normal	No	No	
sym_hi	sym_hi	Not Available			Kernel Driver		No
	Disabled	Stopped	OK	Normal	No	No	
sym_u3	sym_u3	Not Available			Kernel Driver		No
	Disabled	Stopped	OK	Normal	No	No	
tcpip	TCP/IP Protocol Driver	c:\windows\system32\drivers\tcpip.sys					
	Kernel Driver	Yes	System	Running	OK	Normal	
	No	Yes					
tdpipe	TDPIPE	c:\windows\system32\drivers\tdpipe.sys					
	Kernel Driver	No	Manual	Stopped	OK	Ignore	
	No	No					
tdtcp	TDTCP	c:\windows\system32\drivers\tdtcp.sys			Kernel Driver		
	No	Manual	Stopped	OK	Ignore	No	No
termdd	Terminal Device Driver						
		c:\windows\system32\drivers\termdd.sys			Kernel Driver		Yes
	System	Running	OK	Normal	No	Yes	
toside	TosIde	Not Available			Kernel Driver		No
	Disabled	Stopped	OK	Normal	No	No	

Appendix C – Tunable Parameters

```

udfs Udfs c:\windows\system32\drivers\udfs.sys File System
Driver No Disabled Stopped OK Normal No No
ultra ultra Not Available Kernel Driver No Disabled
Stopped OK Normal No No
update Microcode Update Driver
c:\windows\system32\drivers\update.sys Kernel Driver Yes
Manual Running OK Normal No Yes
usbhub USB2 Enabled Hub c:\windows\system32\drivers\usbhub.sys
Kernel Driver No Manual Stopped OK Normal
No No
usbohci Microsoft USB Open Host Controller Miniport Driver
c:\windows\system32\drivers\usbohci.sys Kernel Driver No
Manual Stopped OK Normal No No
vgasave VGA Display Controller. c:\windows\system32\drivers\vga.sys
Kernel Driver Yes System Running OK Ignore
No Yes
viaide ViaIde Not Available Kernel Driver No
Disabled Stopped OK Normal No No
volsnap VolSnap c:\windows\system32\drivers\volsnap.sys
Kernel Driver Yes Boot Running OK Normal No
Yes
wanarp Remote Access IP ARP Driver
c:\windows\system32\drivers\wanarp.sys Kernel Driver Yes
Manual Running OK Normal No Yes
wdica WDICA Not Available Kernel Driver No Manual
Stopped OK Ignore No No
wlbs Network Load Balancing c:\windows\system32\drivers\wlbs.sys
Kernel Driver No Manual Stopped OK Normal
No No

```

[Signed Drivers]

```

Device Name Signed Device Class Driver Version Driver Date
Manufacturer INF Name Driver Name Device ID
Not Available Not Available Not Available Not Available
Not Available Not Available Not Available Not
Available HTREE\ROOT\0
ACPI Multiprocessor PC No COMPUTER 5.2.3663.0 7/15/2002
(Standard computers) hal.inf Not Available
ROOT\ACPI_HAL\0000
Microsoft ACPI-Compliant System No SYSTEM 5.2.3663.0
7/15/2002 Microsoft acpi.inf Not Available
ACPI_HAL\PNP0C08\0
Processor No PROCESSOR 5.2.3663.0 7/15/2002 (Standard
processor types) cpu.inf Not Available ACPI\GENUINEINTEL_-
_X86_FAMILY_15_MODEL_2\0
Processor No PROCESSOR 5.2.3663.0 7/15/2002 (Standard
processor types) cpu.inf Not Available ACPI\GENUINEINTEL_-
_X86_FAMILY_15_MODEL_2\1
Processor No PROCESSOR 5.2.3663.0 7/15/2002 (Standard
processor types) cpu.inf Not Available ACPI\GENUINEINTEL_-
_X86_FAMILY_15_MODEL_2\2
Processor No PROCESSOR 5.2.3663.0 7/15/2002 (Standard
processor types) cpu.inf Not Available ACPI\GENUINEINTEL_-
_X86_FAMILY_15_MODEL_2\3

```

Appendix C – Tunable Parameters

Processor No PROCESSOR 5.2.3663.0 7/15/2002 (Standard
processor types) cpu.inf Not Available ACPI\GENUINEINTEL_
_X86_FAMILY_15_MODEL_2_4

Processor No PROCESSOR 5.2.3663.0 7/15/2002 (Standard
processor types) cpu.inf Not Available ACPI\GENUINEINTEL_
_X86_FAMILY_15_MODEL_2_5

Processor No PROCESSOR 5.2.3663.0 7/15/2002 (Standard
processor types) cpu.inf Not Available ACPI\GENUINEINTEL_
_X86_FAMILY_15_MODEL_2_6

Processor No PROCESSOR 5.2.3663.0 7/15/2002 (Standard
processor types) cpu.inf Not Available ACPI\GENUINEINTEL_
_X86_FAMILY_15_MODEL_2_7

PCI bus No SYSTEM 5.2.3663.0 7/15/2002 (Standard system
devices) machine.inf Not Available ACPI\PNP0A03\1

ServerWorks Grand Champion - NorthBridge High End No SYSTEM
5.2.3663.0 7/15/2002 ServerWorks (RCC) machine.inf Not
Available
PCI\VEN_1166&DEV_0011&SUBSYS_00000000&REV_22\3&13C0B0C5&0&00

ServerWorks Grand Champion - NorthBridge High End No SYSTEM
5.2.3663.0 7/15/2002 ServerWorks (RCC) machine.inf Not
Available
PCI\VEN_1166&DEV_0011&SUBSYS_00000000&REV_00\3&13C0B0C5&0&01

ServerWorks Grand Champion - NorthBridge High End No SYSTEM
5.2.3663.0 7/15/2002 ServerWorks (RCC) machine.inf Not
Available
PCI\VEN_1166&DEV_0011&SUBSYS_00000000&REV_00\3&13C0B0C5&0&02

ServerWorks Grand Champion - NorthBridge High End No SYSTEM
5.2.3663.0 7/15/2002 ServerWorks (RCC) machine.inf Not
Available
PCI\VEN_1166&DEV_0011&SUBSYS_00000000&REV_00\3&13C0B0C5&0&03

Adaptec AIC-7892 Ultra160 PCI SCSI Card No SCSIADAPTER 5.2.3663.0
7/15/2002 Adaptec pnpscsi.inf Not Available
PCI\VEN_9005&DEV_008F&SUBSYS_01091028&REV_02\3&13C0B0C5&0&18

Disk drive No DISKDRIVE 5.2.3663.0 7/15/2002 (Standard disk
drives) disk.inf Not Available
SCSI\DISK&VEN_SEAGATE&PROD_ST318406LC&REV_8A03\4&39BE13D2&0&000

Disk drive No DISKDRIVE 5.2.3663.0 7/15/2002 (Standard disk
drives) disk.inf Not Available
SCSI\DISK&VEN_SEAGATE&PROD_ST318305LC&REV_2203\4&39BE13D2&0&010

PE 1x8 Backplane No SYSTEM 5.2.3663.0 7/15/2002 Dell
scsidev.inf Not Available
SCSI\PROCESSOR&VEN_PE/PV&PROD_1X8_SCSI_BP&REV_1.0\4&39BE13D2&0&06
0

RAGE XL PCI (Microsoft Corporation) No DISPLAY 5.10.2600.6009
7/2/2001 ATI Technologies Inc. atiixpad.inf Not
Available
PCI\VEN_1002&DEV_4752&SUBSYS_01091028&REV_27\3&13C0B0C5&0&20

Dell 1726T-HS/D1025HT No MONITOR 5.1.2001.0 6/6/2001 Dell
Computer Corp. monitor.inf Not Available
DISPLAY\DEL5319\4&C321929&0&80000001&00&04

PCI standard host CPU bridge No SYSTEM 5.2.3663.0 7/15/2002
(Standard system devices) machine.inf Not Available
PCI\VEN_1166&DEV_0201&SUBSYS_00000000&REV_93\3&13C0B0C5&0&78

Appendix C – Tunable Parameters

Direct memory access controller No SYSTEM 5.2.3663.0
 7/15/2002 (Standard system devices) machine.inf Not Available
 Available ACPI\PNP0200\4&25F73A82&0
 Numeric data processor No SYSTEM 5.2.3663.0 7/15/2002
 (Standard system devices) machine.inf Not Available
 ACPI\PNP0C04\4&25F73A82&0
 Programmable interrupt controller No SYSTEM 5.2.3663.0
 7/15/2002 (Standard system devices) machine.inf Not Available
 Available ACPI\PNP0000\4&25F73A82&0
 System speaker No SYSTEM 5.2.3663.0 7/15/2002 (Standard
 system devices) machine.inf Not Available
 ACPI\PNP0800\4&25F73A82&0
 System timer No SYSTEM 5.2.3663.0 7/15/2002 (Standard
 system devices) machine.inf Not Available
 ACPI\PNP0100\4&25F73A82&0
 Standard floppy disk controller No FDC 5.2.3663.0 7/15/2002
 (Standard floppy disk controllers) fdc.inf Not Available
 ACPI\PNP0700\4&25F73A82&0
 Floppy disk drive No FLOPPYDISK 5.2.3663.0 7/15/2002 (Standard
 floppy disk drives) flpydisk.inf Not Available
 FDC\GENERIC_FLOPPY_DRIVE\5&1AE2F47D&0&0
 Standard 101/102-Key or Microsoft Natural PS/2 Keyboard No
 KEYBOARD 5.2.3663.0 7/15/2002 (Standard keyboards)
 keyboard.inf Not Available ACPI\PNP0303\4&25F73A82&0
 PS/2 Compatible Mouse No MOUSE 5.2.3663.0 7/15/2002 Microsoft
 msmouse.inf Not Available ACPI\PNP0F13\4&25F73A82&0
 Communications Port No PORTS 5.2.3663.0 7/15/2002 (Standard
 port types) msports.inf Not Available ACPI\PNP0501\1
 System CMOS/real time clock No SYSTEM 5.2.3663.0 7/15/2002
 (Standard system devices) machine.inf Not Available
 ACPI\PNP0B00\4&25F73A82&0
 System board No SYSTEM 5.2.3663.0 7/15/2002 (Standard
 system devices) machine.inf Not Available ACPI\PNP0C01\2
 System board No SYSTEM 5.2.3663.0 7/15/2002 (Standard
 system devices) machine.inf Not Available ACPI\PNP0C01\1
 Standard Dual Channel PCI IDE Controller No HDC 5.2.3663.0
 7/15/2002 (Standard IDE ATA/ATAPI controllers) mshdc.inf
 Not Available
 PCI\VEN_1166&DEV_0212&SUBSYS_02121166&REV_93\3&13C0B0C5&0&79
 Primary IDE Channel No HDC 5.2.3663.0 7/15/2002 (Standard
 IDE ATA/ATAPI controllers) mshdc.inf Not Available
 PCIIDE\IDECHANNEL\4&10A8249&0&0
 CD-ROM Drive No CDROM 5.2.3663.0 7/15/2002 (Standard CD-ROM
 drives) cdrom.inf Not Available IDE\CDROMTEAC_CD-
 224E_____3.7D____\5&3125DC91&0&0.0.0
 Secondary IDE Channel No HDC 5.2.3663.0 7/15/2002 (Standard
 IDE ATA/ATAPI controllers) mshdc.inf Not Available
 PCIIDE\IDECHANNEL\4&10A8249&0&1
 PCI standard ISA bridge No SYSTEM 5.2.3663.0 7/15/2002
 (Standard system devices) machine.inf Not Available
 PCI\VEN_1166&DEV_0225&SUBSYS_00000000&REV_00\3&13C0B0C5&0&7B
 ISAPNP Read Data Port No SYSTEM 5.2.3663.0 7/15/2002
 (Standard system devices) machine.inf Not Available
 ISAPNP\READDATAPORT\0

Appendix C – Tunable Parameters

PCI standard host CPU bridge No SYSTEM 5.2.3663.0 7/15/2002
(Standard system devices) machine.inf Not Available
PCI\VEN_1166&DEV_0010&SUBSYS_00000000&REV_03\3&13C0B0C5&0&80

PCI standard host CPU bridge No SYSTEM 5.2.3663.0 7/15/2002
(Standard system devices) machine.inf Not Available
PCI\VEN_1166&DEV_0010&SUBSYS_00000000&REV_03\3&13C0B0C5&0&82

PCI standard host CPU bridge No SYSTEM 5.2.3663.0 7/15/2002
(Standard system devices) machine.inf Not Available
PCI\VEN_1166&DEV_0010&SUBSYS_00000000&REV_03\3&13C0B0C5&0&88

PCI standard host CPU bridge No SYSTEM 5.2.3663.0 7/15/2002
(Standard system devices) machine.inf Not Available
PCI\VEN_1166&DEV_0010&SUBSYS_00000000&REV_03\3&13C0B0C5&0&8A

PCI standard host CPU bridge No SYSTEM 5.2.3663.0 7/15/2002
(Standard system devices) machine.inf Not Available
PCI\VEN_1166&DEV_0010&SUBSYS_00000000&REV_03\3&13C0B0C5&0&90

PCI standard host CPU bridge No SYSTEM 5.2.3663.0 7/15/2002
(Standard system devices) machine.inf Not Available
PCI\VEN_1166&DEV_0010&SUBSYS_00000000&REV_03\3&13C0B0C5&0&92

PCI bus No SYSTEM 5.2.3663.0 7/15/2002 (Standard system
devices) machine.inf Not Available ACPI\PNP0A03\2

DEC 21154 PCI to PCI bridge No SYSTEM 5.2.3663.0 7/15/2002
DEC machine.inf Not Available
PCI\VEN_1011&DEV_0026&SUBSYS_00000000&REV_05\3&1070020&0&08

Mylex eXtremeRAID 2000 Disk Array Controller (Accelerated) No
SCSIADAPTER 7.0.14.0 9/9/2002 Mylex oem1.inf Not
Available
PCI\VEN_1069&DEV_BA56&SUBSYS_00401069&REV_00\4&235BDD1F&0&4008

DELL PV22XS Backplane No SYSTEM 5.2.3663.0 7/15/2002 Dell
scsidev.inf Not Available
SCSI\PROCESSOR&VEN_DELL&PROD_PV22XS&REV_E.10\5&22275B46&0&260

DELL PV22XS Backplane No SYSTEM 5.2.3663.0 7/15/2002 Dell
scsidev.inf Not Available
SCSI\PROCESSOR&VEN_DELL&PROD_PV22XS&REV_E.10\5&22275B46&0&360

Mylex RAID Disk Device No DISKDRIVE 5.2.3663.0 7/15/2002 Mylex
disk.inf Not Available
SCSI\DISK&VEN_MYLEX&PROD_EXTREMERAIID_2000&REV_0600\5&22275B46&0&4
00

Mylex GAM Device No SYSTEM 5.2.3663.0 7/15/2002 Mylex
scsidev.inf Not Available
SCSI\PROCESSOR&VEN_MYLEX&PROD_GAM_DEVICE&REV_\5&22275B46&0&660

PCI bus No SYSTEM 5.2.3663.0 7/15/2002 (Standard system
devices) machine.inf Not Available ACPI\PNP0A03\3

Broadcom NetXtreme Gigabit Ethernet No NET 2.67.0.0 7/15/2002
Broadcom netb57xp.inf Not Available
PCI\VEN_14E4&DEV_1644&SUBSYS_01091028&REV_14\3&29E81982&0&08

Broadcom NetXtreme Gigabit Ethernet No NET 2.67.0.0 7/15/2002
Broadcom netb57xp.inf Not Available
PCI\VEN_14E4&DEV_1644&SUBSYS_01091028&REV_14\3&29E81982&0&10

PCI bus No SYSTEM 5.2.3663.0 7/15/2002 (Standard system
devices) machine.inf Not Available ACPI\PNP0A03\4

DEC 21154 PCI to PCI bridge No SYSTEM 5.2.3663.0 7/15/2002
DEC machine.inf Not Available
PCI\VEN_1011&DEV_0026&SUBSYS_00000000&REV_05\3&172E68DD&0&08

Mylex eXtremeRAID 2000 Disk Array Controller (Accelerated) No
SCSIADAPTER 7.0.14.0 9/9/2002 Mylex oem1.inf Not

Appendix C – Tunable Parameters

Available

PCI\VEN_1069&DEV_BA56&SUBSYS_00401069&REV_00\4&2AAB4416&0&4008
DELL PV22XS Backplane No SYSTEM 5.2.3663.0 7/15/2002 Dell
scsidev.inf Not Available
SCSI\PROCESSOR&VEN_DELL&PROD_PV22XS&REV_E.10\5&54721FD&0&060
DELL PV22XS Backplane No SYSTEM 5.2.3663.0 7/15/2002 Dell
scsidev.inf Not Available
SCSI\PROCESSOR&VEN_DELL&PROD_PV22XS&REV_E.10\5&54721FD&0&160
DELL PV22XS Backplane No SYSTEM 5.2.3663.0 7/15/2002 Dell
scsidev.inf Not Available
SCSI\PROCESSOR&VEN_DELL&PROD_PV22XS&REV_E.10\5&54721FD&0&260
DELL PV22XS Backplane No SYSTEM 5.2.3663.0 7/15/2002 Dell
scsidev.inf Not Available
SCSI\PROCESSOR&VEN_DELL&PROD_PV22XS&REV_E.10\5&54721FD&0&360
Mylex RAID Disk Device No DISKDRIVE 5.2.3663.0 7/15/2002 Mylex
disk.inf Not Available
SCSI\DISK&VEN_MYLEX&PROD_EXTREMER RAID_2000&REV_0600\5&54721FD&0&40
0
Mylex GAM Device No SYSTEM 5.2.3663.0 7/15/2002 Mylex
scsidev.inf Not Available
SCSI\PROCESSOR&VEN_MYLEX&PROD_GAM_DEVICE&REV_\5&54721FD&0&660
PCI bus No SYSTEM 5.2.3663.0 7/15/2002 (Standard system
devices) machine.inf Not Available ACPI\PNP0A03\5
DEC 21154 PCI to PCI bridge No SYSTEM 5.2.3663.0 7/15/2002
DEC machine.inf Not Available
PCI\VEN_1011&DEV_0026&SUBSYS_00000000&REV_05\3&474B838&0&08
Mylex eXtremeRAID 2000 Disk Array Controller (Accelerated) No
SCSIADAPTER 7.0.14.0 9/9/2002 Mylex oem1.inf Not

Available

PCI\VEN_1069&DEV_BA56&SUBSYS_00401069&REV_00\4&18212E42&0&4008
DELL PV22XS Backplane No SYSTEM 5.2.3663.0 7/15/2002 Dell
scsidev.inf Not Available
SCSI\PROCESSOR&VEN_DELL&PROD_PV22XS&REV_E.10\5&185D32FD&0&060
DELL PV22XS Backplane No SYSTEM 5.2.3663.0 7/15/2002 Dell
scsidev.inf Not Available
SCSI\PROCESSOR&VEN_DELL&PROD_PV22XS&REV_E.10\5&185D32FD&0&160
DELL PV22XS Backplane No SYSTEM 5.2.3663.0 7/15/2002 Dell
scsidev.inf Not Available
SCSI\PROCESSOR&VEN_DELL&PROD_PV22XS&REV_E.10\5&185D32FD&0&260
DELL PV22XS Backplane No SYSTEM 5.2.3663.0 7/15/2002 Dell
scsidev.inf Not Available
SCSI\PROCESSOR&VEN_DELL&PROD_PV22XS&REV_E.10\5&185D32FD&0&360
Mylex RAID Disk Device No DISKDRIVE 5.2.3663.0 7/15/2002 Mylex
disk.inf Not Available
SCSI\DISK&VEN_MYLEX&PROD_EXTREMER RAID_2000&REV_0600\5&185D32FD&0&4
00
Mylex GAM Device No SYSTEM 5.2.3663.0 7/15/2002 Mylex
scsidev.inf Not Available
SCSI\PROCESSOR&VEN_MYLEX&PROD_GAM_DEVICE&REV_\5&185D32FD&0&660
PCI bus No SYSTEM 5.2.3663.0 7/15/2002 (Standard system
devices) machine.inf Not Available ACPI\PNP0A03\6
DEC 21154 PCI to PCI bridge No SYSTEM 5.2.3663.0 7/15/2002
DEC machine.inf Not Available
PCI\VEN_1011&DEV_0026&SUBSYS_00000000&REV_05\3&E44F86D&0&10

Appendix C – Tunable Parameters

Mylex eXtremeRAID 2000 Disk Array Controller (Accelerated) No
SCSIADAPTER 7.0.14.0 9/9/2002 Mylex oem1.inf Not
Available
PCI\VEN_1069&DEV_BA56&SUBSYS_00401069&REV_00\4&18595B4B&0&4010
DELL PV22XS Backplane No SYSTEM 5.2.3663.0 7/15/2002 Dell
scsidev.inf Not Available
SCSI\PROCESSOR&VEN_DELL&PROD_PV22XS&REV_E.10\5&30D9988F&0&060
DELL PV22XS Backplane No SYSTEM 5.2.3663.0 7/15/2002 Dell
scsidev.inf Not Available
SCSI\PROCESSOR&VEN_DELL&PROD_PV22XS&REV_E.10\5&30D9988F&0&160
DELL PV22XS Backplane No SYSTEM 5.2.3663.0 7/15/2002 Dell
scsidev.inf Not Available
SCSI\PROCESSOR&VEN_DELL&PROD_PV22XS&REV_E.10\5&30D9988F&0&260
DELL PV22XS Backplane No SYSTEM 5.2.3663.0 7/15/2002 Dell
scsidev.inf Not Available
SCSI\PROCESSOR&VEN_DELL&PROD_PV22XS&REV_E.10\5&30D9988F&0&360
Mylex RAID Disk Device No DISKDRIVE 5.2.3663.0 7/15/2002 Mylex
disk.inf Not Available
SCSI\DISK&VEN_MYLEX&PROD_EXTREMER RAID_2000&REV_0600\5&30D9988F&0&4
00
Mylex GAM Device No SYSTEM 5.2.3663.0 7/15/2002 Mylex
scsidev.inf Not Available
SCSI\PROCESSOR&VEN_MYLEX&PROD_GAM_DEVICE&REV_\5&30D9988F&0&660
PCI bus No SYSTEM 5.2.3663.0 7/15/2002 (Standard system
devices) machine.inf Not Available ACPI\PNP0A03\7
DEC 21154 PCI to PCI bridge No SYSTEM 5.2.3663.0 7/15/2002
DEC machine.inf Not Available
PCI\VEN_1011&DEV_0026&SUBSYS_00000000&REV_05\3&20FEA912&0&08
Mylex eXtremeRAID 2000 Disk Array Controller (Accelerated) No
SCSIADAPTER 7.0.14.0 9/9/2002 Mylex oem1.inf Not
Available
PCI\VEN_1069&DEV_BA56&SUBSYS_00401069&REV_00\4&13747BCE&0&4008
DELL PV22XS Backplane No SYSTEM 5.2.3663.0 7/15/2002 Dell
scsidev.inf Not Available
SCSI\PROCESSOR&VEN_DELL&PROD_PV22XS&REV_E.10\5&A89AE50&0&060
DELL PV22XS Backplane No SYSTEM 5.2.3663.0 7/15/2002 Dell
scsidev.inf Not Available
SCSI\PROCESSOR&VEN_DELL&PROD_PV22XS&REV_E.10\5&A89AE50&0&160
DELL PV22XS Backplane No SYSTEM 5.2.3663.0 7/15/2002 Dell
scsidev.inf Not Available
SCSI\PROCESSOR&VEN_DELL&PROD_PV22XS&REV_E.10\5&A89AE50&0&260
DELL PV22XS Backplane No SYSTEM 5.2.3663.0 7/15/2002 Dell
scsidev.inf Not Available
SCSI\PROCESSOR&VEN_DELL&PROD_PV22XS&REV_E.10\5&A89AE50&0&360
Mylex RAID Disk Device No DISKDRIVE 5.2.3663.0 7/15/2002 Mylex
disk.inf Not Available
SCSI\DISK&VEN_MYLEX&PROD_EXTREMER RAID_2000&REV_0600\5&A89AE50&0&40
0
Mylex GAM Device No SYSTEM 5.2.3663.0 7/15/2002 Mylex
scsidev.inf Not Available
SCSI\PROCESSOR&VEN_MYLEX&PROD_GAM_DEVICE&REV_\5&A89AE50&0&660
DEC 21154 PCI to PCI bridge No SYSTEM 5.2.3663.0 7/15/2002
DEC machine.inf Not Available
PCI\VEN_1011&DEV_0026&SUBSYS_00000000&REV_05\3&20FEA912&0&10

Appendix C – Tunable Parameters

```

Mylex eXtremeRAID 2000 Disk Array Controller (Accelerated) No
  SCSIADAPTER 7.0.14.0 9/9/2002 Mylex oem1.inf Not
Available
  PCI\VEN_1069&DEV_BA56&SUBSYS_00401069&REV_00\4&30064324&0&4010
DELL PV22XS Backplane No SYSTEM 5.2.3663.0 7/15/2002 Dell
  scsidev.inf Not Available
  SCSI\PROCESSOR&VEN_DELL&PROD_PV22XS&REV_E.10\5&22B0559B&0&060
DELL PV22XS Backplane No SYSTEM 5.2.3663.0 7/15/2002 Dell
  scsidev.inf Not Available
  SCSI\PROCESSOR&VEN_DELL&PROD_PV22XS&REV_E.10\5&22B0559B&0&160
DELL PV22XS Backplane No SYSTEM 5.2.3663.0 7/15/2002 Dell
  scsidev.inf Not Available
  SCSI\PROCESSOR&VEN_DELL&PROD_PV22XS&REV_E.10\5&22B0559B&0&260
DELL PV22XS Backplane No SYSTEM 5.2.3663.0 7/15/2002 Dell
  scsidev.inf Not Available
  SCSI\PROCESSOR&VEN_DELL&PROD_PV22XS&REV_E.10\5&22B0559B&0&360
Mylex RAID Disk Device No DISKDRIVE 5.2.3663.0 7/15/2002 Mylex
  disk.inf Not Available
  SCSI\DISK&VEN_MYLEX&PROD_EXTREMER RAID_2000&REV_0600\5&22B0559B&0&4
00
Mylex GAM Device No SYSTEM 5.2.3663.0 7/15/2002 Mylex
  scsidev.inf Not Available
  SCSI\PROCESSOR&VEN_MYLEX&PROD_GAM_DEVICE&REV_\5&22B0559B&0&660
ACPI Fixed Feature Button No SYSTEM 5.2.3663.0 7/15/2002
  (Standard system devices) machine.inf Not Available
  ACPI\FIXEDBUTTON\2&DABA3FF&0
Logical Disk Manager No SYSTEM 5.2.3663.0 7/15/2002
  (Standard system devices) machine.inf Not Available
  ROOT\DMIO\0000
Volume Manager No SYSTEM 5.2.3663.0 7/15/2002 (Standard
  system devices) machine.inf Not Available ROOT\FTDISK\0000
Generic volume No VOLUME 5.2.3663.0 7/15/2002 Microsoft
  volume.inf Not Available
  STORAGE\VOLUME\1&30A96598&0&SIGNATUREEE9EAE9EAOFFSET7E00LENGTH21DB
DA400
Generic volume No VOLUME 5.2.3663.0 7/15/2002 Microsoft
  volume.inf Not Available
  STORAGE\VOLUME\1&30A96598&0&SIGNATUREEE9EAE9EAOFFSET21DBE2200LENGT
H21F36A800
Generic volume No VOLUME 5.2.3663.0 7/15/2002 Microsoft
  volume.inf Not Available
  STORAGE\VOLUME\1&30A96598&0&SIGNATURE9A3DEE00OFFSET7E00LENGTH43C7
6CA00
Generic volume No VOLUME 5.2.3663.0 7/15/2002 Microsoft
  volume.inf Not Available
  STORAGE\VOLUME\1&30A96598&0&SIGNATURE22E46A0DOFFSET7E00LENGTH65B1
8DDC00
Generic volume No VOLUME 5.2.3663.0 7/15/2002 Microsoft
  volume.inf Not Available
  STORAGE\VOLUME\1&30A96598&0&SIGNATURE7BD99CA4OFFSET7E00LENGTH25C2
0F8A00
Generic volume No VOLUME 5.2.3663.0 7/15/2002 Microsoft
  volume.inf Not Available
  STORAGE\VOLUME\1&30A96598&0&SIGNATURE7BD99CA4OFFSET25C2100800LENG
TH14E838CA00

```

Appendix C – Tunable Parameters

Generic volume	No	VOLUME	5.2.3663.0	7/15/2002	Microsoft
volume.inf	Not Available				
STORAGE\VOLUME\1&30A96598&0&SIGNATURE7BD99CA4OFFSET3AAA48D200LENG TH493E2E4A00					
Generic volume	No	VOLUME	5.2.3663.0	7/15/2002	Microsoft
volume.inf	Not Available				
STORAGE\VOLUME\1&30A96598&0&SIGNATURE87828458OFFSET7E00LENGTH25C2 0F8A00					
Generic volume	No	VOLUME	5.2.3663.0	7/15/2002	Microsoft
volume.inf	Not Available				
STORAGE\VOLUME\1&30A96598&0&SIGNATURE87828458OFFSET25C2100800LENG TH14E838CA00					
Generic volume	No	VOLUME	5.2.3663.0	7/15/2002	Microsoft
volume.inf	Not Available				
STORAGE\VOLUME\1&30A96598&0&SIGNATURE87828458OFFSET3AAA48D200LENG TH493E2E4A00					
Generic volume	No	VOLUME	5.2.3663.0	7/15/2002	Microsoft
volume.inf	Not Available				
STORAGE\VOLUME\1&30A96598&0&SIGNATURE7BD99CA7OFFSET7E00LENGTH25C2 0F8A00					
Generic volume	No	VOLUME	5.2.3663.0	7/15/2002	Microsoft
volume.inf	Not Available				
STORAGE\VOLUME\1&30A96598&0&SIGNATURE7BD99CA7OFFSET25C2100800LENG TH14E838CA00					
Generic volume	No	VOLUME	5.2.3663.0	7/15/2002	Microsoft
volume.inf	Not Available				
STORAGE\VOLUME\1&30A96598&0&SIGNATURE7BD99CA7OFFSET3AAA48D200LENG TH493E2E4A00					
Generic volume	No	VOLUME	5.2.3663.0	7/15/2002	Microsoft
volume.inf	Not Available				
STORAGE\VOLUME\1&30A96598&0&SIGNATURE7BDAB6A8OFFSET7E00LENGTH25C2 0F8A00					
Generic volume	No	VOLUME	5.2.3663.0	7/15/2002	Microsoft
volume.inf	Not Available				
STORAGE\VOLUME\1&30A96598&0&SIGNATURE7BDAB6A8OFFSET25C2100800LENG TH14E838CA00					
Generic volume	No	VOLUME	5.2.3663.0	7/15/2002	Microsoft
volume.inf	Not Available				
STORAGE\VOLUME\1&30A96598&0&SIGNATURE7BDAB6A8OFFSET3AAA48D200LENG TH493E2E4A00					
Generic volume	No	VOLUME	5.2.3663.0	7/15/2002	Microsoft
volume.inf	Not Available				
STORAGE\VOLUME\1&30A96598&0&SIGNATURE7BD99CA5OFFSET7E00LENGTH25C2 0F8A00					
Generic volume	No	VOLUME	5.2.3663.0	7/15/2002	Microsoft
volume.inf	Not Available				
STORAGE\VOLUME\1&30A96598&0&SIGNATURE7BD99CA5OFFSET25C2100800LENG TH14E838CA00					
Generic volume	No	VOLUME	5.2.3663.0	7/15/2002	Microsoft
volume.inf	Not Available				
STORAGE\VOLUME\1&30A96598&0&SIGNATURE7BD99CA5OFFSET3AAA48D200LENG TH493E2E4A00					
AFD Networking Support Environment	Not Available				LEGACYDRIVER
Not Available	Not Available	Not Available	Not Available	Not Available	Not
Available	Not Available		ROOT\LEGACY_AFD\0000		

Appendix C – Tunable Parameters

Beep	Not Available	LEGACYDRIVER	Not Available	Not Available
Available	Not Available	Not Available	Not Available	
	ROOT\LEGACY_BEEP\0000			
CRC Disk Filter Driver	Not Available	LEGACYDRIVER	Not Available	Not Available
Available	Not Available	Not Available	Not Available	Not Available
Available	ROOT\LEGACY_CRCDISK\0000			
dmboot	Not Available	LEGACYDRIVER	Not Available	Not Available
Available	Not Available	Not Available	Not Available	Not Available
	ROOT\LEGACY_DMBOOT\0000			
dmload	Not Available	LEGACYDRIVER	Not Available	Not Available
Available	Not Available	Not Available	Not Available	Not Available
	ROOT\LEGACY_DMLOAD\0000			
Fips	Not Available	LEGACYDRIVER	Not Available	Not Available
Available	Not Available	Not Available	Not Available	Not Available
	ROOT\LEGACY_FIPS\0000			
Generic Packet Classifier	Not Available	LEGACYDRIVER	Not Available	Not Available
Available	Not Available	Not Available	Not Available	Not Available
Available	ROOT\LEGACY_GPC\0000			
IPSEC driver	Not Available	LEGACYDRIVER	Not Available	Not Available
Available	Not Available	Not Available	Not Available	Not Available
	ROOT\LEGACY_IPSEC\0000			
ksecdd	Not Available	LEGACYDRIVER	Not Available	Not Available
Available	Not Available	Not Available	Not Available	Not Available
	ROOT\LEGACY_KSECDD\0000			
macxp32	Not Available	LEGACYDRIVER	Not Available	Not Available
Available	Not Available	Not Available	Not Available	Not Available
	ROOT\LEGACY_MACXP32\0000			
mnmdd	Not Available	LEGACYDRIVER	Not Available	Not Available
Available	Not Available	Not Available	Not Available	Not Available
	ROOT\LEGACY_MNMDD\0000			
mountmgr	Not Available	LEGACYDRIVER	Not Available	Not Available
Available	Not Available	Not Available	Not Available	Not Available
	ROOT\LEGACY_MOUNTMGR\0000			
NDIS System Driver	Not Available	LEGACYDRIVER	Not Available	Not Available
Available	Not Available	Not Available	Not Available	Not Available
Available	ROOT\LEGACY_NDIS\0000			
Remote Access NDIS TAPI Driver	Not Available	LEGACYDRIVER	Not Available	Not Available
Available	Not Available	Not Available	Not Available	Not Available
	ROOT\LEGACY_NDISTAPI\0000			
NDIS Usermode I/O Protocol	Not Available	LEGACYDRIVER	Not Available	Not Available
Available	Not Available	Not Available	Not Available	Not Available
Available	ROOT\LEGACY_NDISUIO\0000			
NDProxy	Not Available	LEGACYDRIVER	Not Available	Not Available
Available	Not Available	Not Available	Not Available	Not Available
	ROOT\LEGACY_NDPROXY\0000			
NetBios over Tcip	Not Available	LEGACYDRIVER	Not Available	Not Available
Available	Not Available	Not Available	Not Available	Not Available
Available	ROOT\LEGACY_NETBT\0000			
Null	Not Available	LEGACYDRIVER	Not Available	Not Available
Available	Not Available	Not Available	Not Available	Not Available
	ROOT\LEGACY_NULL\0000			
Partition Manager	Not Available	LEGACYDRIVER	Not Available	Not Available
Available	Not Available	Not Available	Not Available	Not Available
	ROOT\LEGACY_PARTMGR\0000			

Appendix C – Tunable Parameters

ParVdm	Not Available	LEGACYDRIVER	Not Available	Not
Available	Not Available	Not Available	Not Available	
ROOT\LEGACY_PARVDM\0000				
Remote Access Auto Connection Driver			Not Available	
LEGACYDRIVER	Not Available		Not Available	Not
Available	Not Available	Not Available	ROOT\LEGACY_RASACD\0000	
RDPCDD	Not Available	LEGACYDRIVER	Not Available	Not
Available	Not Available	Not Available	Not Available	
ROOT\LEGACY_RDPCDD\0000				
TCP/IP Protocol Driver	Not Available	LEGACYDRIVER		Not
Available	Not Available	Not Available	Not Available	Not
Available	ROOT\LEGACY_TCPIP\0000			
VGA Display Controller.	Not Available	LEGACYDRIVER		Not
Available	Not Available	Not Available	Not Available	Not
Available	ROOT\LEGACY_VGASAVE\0000			
volsnap	Not Available	LEGACYDRIVER	Not Available	Not
Available	Not Available	Not Available	Not Available	
ROOT\LEGACY_VOLSNAP\0000				
Remote Access IP ARP Driver	Not Available	LEGACYDRIVER		Not
Available	Not Available	Not Available	Not Available	Not
Available	ROOT\LEGACY_WANARP\0000			
Audio Codecs	No	MEDIA 5.2.3663.0	7/15/2002	(Standard system devices)
	wave.inf	Not Available	ROOT\MEDIA\MS_MMACM	
Legacy Audio Drivers	No	MEDIA 5.2.3663.0	7/15/2002	(Standard system devices)
	wave.inf	Not Available	ROOT\MEDIA\MS_MMDRV	
Media Control Devices	No	MEDIA 5.2.3663.0	7/15/2002	(Standard system devices)
	wave.inf	Not Available	ROOT\MEDIA\MS_MMMCI	
Legacy Video Capture Devices	No	MEDIA 5.2.3663.0	7/15/2002	(Standard system devices)
	wave.inf	Not Available	ROOT\MEDIA\MS_MMVCD	
Video Codecs	No	MEDIA 5.2.3663.0	7/15/2002	(Standard system devices)
	wave.inf	Not Available	ROOT\MEDIA\MS_MMVID	
WAN Miniport (L2TP)	No	NET 5.2.3663.0	7/15/2002	Microsoft
	netrasa.inf	Not Available	ROOT\MS_L2TPMINIPORT\0000	
WAN Miniport (IP)	No	NET 5.2.3663.0	7/15/2002	Microsoft
	netrasa.inf	Not Available	ROOT\MS_NDISWANIP\0000	
WAN Miniport (PPPOE)	No	NET 5.2.3663.0	7/15/2002	Microsoft
	netrasa.inf	Not Available	ROOT\MS_PPPOEMINIPORT\0000	
WAN Miniport (PPTP)	No	NET 5.2.3663.0	7/15/2002	Microsoft
	netrasa.inf	Not Available	ROOT\MS_PPTPMINIPORT\0000	
Direct Parallel	No	NET 5.2.3663.0	7/15/2002	Microsoft
	netrasa.inf	Not Available	ROOT\MS_PTMINIPORT\0000	
Terminal Server Device Redirector	No	SYSTEM 5.2.3663.0	7/15/2002	(Standard system devices)
	machine.inf	Not Available	ROOT\RDPDR\0000	
Terminal Server Keyboard Driver	No	SYSTEM 5.2.3663.0	7/15/2002	(Standard system devices)
	machine.inf	Not Available	ROOT\RDP_KBD\0000	
Terminal Server Mouse Driver	No	SYSTEM 5.2.3663.0	7/15/2002	(Standard system devices)
	machine.inf	Not Available	ROOT\RDP_MOU\0000	
Plug and Play Software Device Enumerator	No	SYSTEM 5.2.3663.0	7/15/2002	(Standard system devices)
	machine.inf	Not Available	ROOT\SYSTEM\0000	

Appendix C – Tunable Parameters

Microcode Update Device No SYSTEM 5.2.3663.0 7/15/2002
(Standard system devices) machine.inf Not Available
ROOT\SYSTEM\0001

[Environment Variables]

Variable	Value	User Name
ClusterLog	C:\WINDOWS\Cluster\cluster.log	<SYSTEM>
ComSpec	%SystemRoot%\system32\cmd.exe	<SYSTEM>
NUMBER_OF_PROCESSORS	8	<SYSTEM>
OS	Windows_NT	<SYSTEM>
Path	%SystemRoot%\system32;%SystemRoot%;%SystemRoot%\System32\Wbem;C:\MSTPCC.422\SETUP\scripts\utility;C:\Program Files\Microsoft SQL Server\MSSQL\Binn;. ;C:\Program Files\Microsoft SQL Server\80\Tools\BINN<SYSTEM>	
PATHEXT	.COM;.EXE;.BAT;.CMD;.VBS;.VBE;.JS;.JSE;.WSF;.WSH	<SYSTEM>
PROCESSOR_ARCHITECTURE	x86	<SYSTEM>
PROCESSOR_IDENTIFIER	x86 Family 15 Model 2 Stepping 2, GenuineIntel	<SYSTEM>
PROCESSOR_LEVEL	15	<SYSTEM>
PROCESSOR_REVISION	0202	<SYSTEM>
TEMP	%SystemRoot%\TEMP	<SYSTEM>
TMP	%SystemRoot%\TEMP	<SYSTEM>
windir	%SystemRoot%	<SYSTEM>
TEMP	%USERPROFILE%\Local Settings\Temp	NT AUTHORITY\SYSTEM
TMP	%USERPROFILE%\Local Settings\Temp	NT AUTHORITY\SYSTEM
TEMP	%USERPROFILE%\Local Settings\Temp	NT AUTHORITY\NETWORK SERVICE
TMP	%USERPROFILE%\Local Settings\Temp	NT AUTHORITY\NETWORK SERVICE
TEMP	%USERPROFILE%\Local Settings\Temp	PE6500\Administrator
TMP	%USERPROFILE%\Local Settings\Temp	PE6500\Administrator

[Print Jobs]

Document	Size	Owner	Notify	Status	Time Submitted	Start
Time	Until	Time	Elapsed	Pages	Printed	Job ID
Priority	Parameters	Driver	Print	Processor	Host	Print
Queue	Data	Type	Name			

[Network Connections]

Local Name	Remote Name	Type	Status	User Name
------------	-------------	------	--------	-----------

[Running Tasks]

Name	Path	Process ID	Priority	Min Working Set	Max Working Set		
Start Time	Version	Size	File Date				
system	idle	process	Not Available	0	0	Not Available	
	Not Available	Not Available	Not Available	Not Available	Not		
Available	Not Available						
system	Available	Not Available	4	8	0	1413120	Not
Available	Not Available	Not Available	Not Available	Not Available	Not Available		

Appendix C – Tunable Parameters

```

smss.exe      c:\windows\system32\smss.exe  368  11  204800
              1413120      12/18/2002 12:16 PM      5.2.3663.0 (main.020715-1506)
              46.00 KB (47,104 bytes) 7/29/2002 1:57 PM
csrss.exe    Not Available      568  13  Not Available      Not
Available    12/18/2002 12:16 PM      Not Available      Not Available
              Not Available
winlogon.exe c:\windows\system32\winlogon.exe 592  13
              204800      1413120      12/18/2002 12:16 PM      5.2.3663.0
(main.020715-1506) 512.00 KB (524,288 bytes) 7/29/2002 2:04 PM
services.exe c:\windows\system32\services.exe 636  9
              204800      1413120      12/18/2002 12:16 PM      5.2.3663.0
(main.020715-1506) 99.00 KB (101,376 bytes) 7/29/2002 1:55 PM
lsass.exe   c:\windows\system32\lsass.exe 648  9  204800
              1413120      12/18/2002 12:16 PM      5.2.3663.0 (main.020715-1506)
              13.00 KB (13,312 bytes) 7/29/2002 1:27 PM
svchost.exe c:\windows\system32\svchost.exe  804  8  204800
              1413120      12/18/2002 12:16 PM      5.2.3663.0 (main.020715-1506)
              12.00 KB (12,288 bytes) 7/29/2002 1:58 PM
svchost.exe c:\windows\system32\svchost.exe  848  8  204800
              1413120      12/18/2002 12:16 PM      5.2.3663.0 (main.020715-1506)
              12.00 KB (12,288 bytes) 7/29/2002 1:58 PM
svchost.exe c:\windows\system32\svchost.exe  968  8  204800
              1413120      12/18/2002 12:16 PM      5.2.3663.0 (main.020715-1506)
              12.00 KB (12,288 bytes) 7/29/2002 1:58 PM
msdtc.exe   Not Available      1056  8  Not Available      Not
Available    12/18/2002 12:16 PM      Not Available      Not Available
              Not Available
explorer.exe c:\windows\explorer.exe 1520  8  204800
              1413120      12/18/2002 12:16 PM      6.00.3663.0 (main.020715-
1506) 989.50 KB (1,013,248 bytes) 7/29/2002 1:18 PM
mmc.exe     c:\windows\system32\mmc.exe  1908  8  204800
              1413120      12/18/2002 2:38 PM      5.2.3663.0 (main.020715-1506)
              758.00 KB (776,192 bytes) 7/29/2002 1:29 PM
dmremote.exe c:\windows\system32\dmremote.exe 1960  8
              204800      1413120      12/18/2002 2:38 PM      5.2.3663.0
(main.020715-1506) 14.50 KB (14,848 bytes) 7/29/2002 1:16 PM
dmadmin.exe c:\windows\system32\dmadmin.exe 1664  8  204800
              1413120      12/18/2002 2:38 PM      5.2.3663.0 (main.020715-1506)
              212.00 KB (217,088 bytes) 7/29/2002 1:16 PM
cmd.exe     c:\windows\system32\cmd.exe  1756  8  204800
              1413120      12/18/2002 5:41 PM      5.2.3663.0 (main.020715-1506)
              371.00 KB (379,904 bytes) 7/29/2002 1:11 PM
sqlservr.exe c:\program files\microsoft sql
server\mssql\binn\sqlservr.exe 540  13  204800      1413120
              12/18/2002 5:41 PM      2000.080.0731.00 7.17 MB (7,516,244
bytes) 12/12/2002 12:10 PM
notepad.exe c:\windows\system32\notepad.exe 340  8  204800
              1413120      12/19/2002 1:43 AM      5.2.3663.0 (main.020715-1506)
              66.00 KB (67,584 bytes) 7/29/2002 1:35 PM
helpctr.exe c:\windows\pchealth\helpctr\binaries\helpctr.exe 328
              8  204800      1413120      12/19/2002 10:35 AM      5.2.3663.0
(main.020715-1506) 670.00 KB (686,080 bytes) 9/25/2002 12:08
PM
helpsvc.exe c:\windows\pchealth\helpctr\binaries\helpsvc.exe 2024
              8  204800      1413120      12/19/2002 10:35 AM      5.2.3663.0

```

Appendix C – Tunable Parameters

(main.020715-1506) 683.50 KB (699,904 bytes) 9/25/2002 12:08 PM
wmiprvse.exe Not Available 480 8 Not Available Not Available
Available 12/19/2002 10:35 AM Not Available Not Available
Not Available
notepad.exe c:\windows\system32\notepad.exe 1920 8 204800
1413120 12/19/2002 10:41 AM 5.2.3663.0 (main.020715-1506)
66.00 KB (67,584 bytes) 7/29/2002 1:35 PM

[Loaded Modules]

Name	Version	Size	File Date	Manufacturer	Path
smss	5.2.3663.0 (main.020715-1506)	46.00 KB (47,104 bytes)	7/29/2002 1:57 PM	Microsoft Corporation	c:\windows\system32\smss.exe
ntdll	5.2.3663.0 (main.020715-1506)	697.50 KB (714,240 bytes)	7/29/2002 1:36 PM	Microsoft Corporation	c:\windows\system32\ntdll.dll
winlogon	5.2.3663.0 (main.020715-1506)	512.00 KB (524,288 bytes)	7/29/2002 2:04 PM	Microsoft Corporation	c:\windows\system32\winlogon.exe
kernel32	5.2.3663.0 (main.020715-1506)	934.50 KB (956,928 bytes)	7/29/2002 1:25 PM	Microsoft Corporation	c:\windows\system32\kernel32.dll
msvcrt	7.0.3663.0 (main.020715-1506)	319.50 KB (327,168 bytes)	7/29/2002 1:33 PM	Microsoft Corporation	c:\windows\system32\msvcrt.dll
advapi32	5.2.3663.0 (main.020715-1506)	526.00 KB (538,624 bytes)	7/29/2002 1:09 PM	Microsoft Corporation	c:\windows\system32\advapi32.dll
rpcrt4	5.2.3663.0 (main.020715-1506)	544.50 KB (557,568 bytes)	7/29/2002 1:51 PM	Microsoft Corporation	c:\windows\system32\rpcrt4.dll
user32	5.2.3663.0 (main.020715-1506)	547.50 KB (560,640 bytes)	7/29/2002 2:01 PM	Microsoft Corporation	c:\windows\system32\user32.dll
gdi32	5.2.3663.0 (main.020715-1506)	246.00 KB (251,904 bytes)	7/29/2002 1:20 PM	Microsoft Corporation	c:\windows\system32\gdi32.dll
userenv	5.2.3663.0 (main.020715-1506)	710.00 KB (727,040 bytes)	7/29/2002 2:01 PM	Microsoft Corporation	c:\windows\system32\userenv.dll
nddeapi	5.2.3663.0 (main.020715-1506)	15.00 KB (15,360 bytes)	7/29/2002 1:33 PM	Microsoft Corporation	c:\windows\system32\nddeapi.dll
crypt32	5.131.3663.0 (main.020715-1506)	545.00 KB (558,080 bytes)	7/29/2002 1:14 PM	Microsoft Corporation	c:\windows\system32\crypt32.dll
msasn1	5.2.3663.0 (main.020715-1506)	51.00 KB (52,224 bytes)	7/29/2002 1:31 PM	Microsoft Corporation	c:\windows\system32\msasn1.dll
secur32	5.2.3663.0 (main.020715-1506)	57.00 KB (58,368 bytes)	7/29/2002 1:55 PM	Microsoft Corporation	c:\windows\system32\secur32.dll

Appendix C – Tunable Parameters

winsta 5.2.3663.0 (main.020715-1506) 48.00 KB (49,152 bytes)
7/29/2002 2:05 PM Microsoft Corporation
c:\windows\system32\winsta.dll

netapi32 5.2.3663.0 (main.020715-1506) 309.50 KB (316,928 bytes)
7/29/2002 1:34 PM Microsoft Corporation
c:\windows\system32\netapi32.dll

profmap 5.2.3663.0 (main.020715-1506) 21.00 KB (21,504 bytes)
7/29/2002 1:50 PM Microsoft Corporation
c:\windows\system32\profmap.dll

regapi 5.2.3663.0 (main.020715-1506) 47.00 KB (48,128 bytes)
7/29/2002 1:51 PM Microsoft Corporation
c:\windows\system32\regapi.dll

ws2_32 5.2.3663.0 (main.020715-1506) 77.00 KB (78,848 bytes)
7/29/2002 2:06 PM Microsoft Corporation
c:\windows\system32\ws2_32.dll

ws2help 5.2.3663.0 (main.020715-1506) 19.00 KB (19,456 bytes)
7/29/2002 2:06 PM Microsoft Corporation
c:\windows\system32\ws2help.dll

authz 5.2.3663.0 (main.020715-1506) 56.50 KB (57,856 bytes) 7/29/2002
1:09 PM Microsoft Corporation c:\windows\system32\authz.dll

psapi 5.2.3663.0 (main.020715-1506) 21.00 KB (21,504 bytes) 7/29/2002
1:50 PM Microsoft Corporation c:\windows\system32\psapi.dll

version 5.2.3663.0 (main.020715-1506) 16.50 KB (16,896 bytes)
7/29/2002 2:02 PM Microsoft Corporation
c:\windows\system32\version.dll

setupapi 5.2.3663.0 (main.020715-1506) 917.50 KB (939,520 bytes)
7/29/2002 1:55 PM Microsoft Corporation
c:\windows\system32\setupapi.dll

msgina 5.2.3663.0 (main.020715-1506) 1.19 MB (1,252,864 bytes)
7/29/2002 1:32 PM Microsoft Corporation
c:\windows\system32\msgina.dll

shsvcs 6.00.3663.0 (main.020715-1506) 122.50 KB (125,440
bytes) 7/29/2002 1:56 PM Microsoft Corporation
c:\windows\system32\shsvcs.dll

shlwapi 6.00.3663.0 (main.020715-1506) 269.00 KB (275,456
bytes) 7/29/2002 1:56 PM Microsoft Corporation
c:\windows\system32\shlwapi.dll

sfc 5.2.3663.0 (main.020715-1506) 4.50 KB (4,608 bytes) 7/29/2002
1:55 PM Microsoft Corporation c:\windows\system32\sfc.dll

sfc_os 5.2.3663.0 (main.020715-1506) 130.00 KB (133,120 bytes)
7/29/2002 1:55 PM Microsoft Corporation
c:\windows\system32\sfc_os.dll

wintrust 5.131.3663.0 (main.020715-1506) 155.00 KB (158,720
bytes) 7/29/2002 2:05 PM Microsoft Corporation
c:\windows\system32\wintrust.dll

ole32 5.2.3663.0 (main.020715-1506) 1.08 MB (1,134,592 bytes)
7/29/2002 1:48 PM Microsoft Corporation
c:\windows\system32\ole32.dll

imagehlp 5.2.3663.0 (main.020715-1506) 123.00 KB (125,952 bytes)
7/29/2002 1:22 PM Microsoft Corporation
c:\windows\system32\imagehlp.dll

comctl32 6.0 (main.020715-1506) 905.00 KB (926,720 bytes)
9/25/2002 6:55 AM Microsoft Corporation
c:\windows\winsxs\x86_microsoft.windows.common-
controls_6595b64144ccf1df_6.0.100.0_x-ww_8417450b\comctl32.dll

Appendix C – Tunable Parameters

winscard 5.2.3663.0 (main.020715-1506) 93.50 KB (95,744 bytes)
7/29/2002 2:05 PM Microsoft Corporation
c:\windows\system32\winscard.dll

wtsapi32 5.2.3663.0 (main.020715-1506) 17.00 KB (17,408 bytes)
7/29/2002 2:07 PM Microsoft Corporation
c:\windows\system32\wtsapi32.dll

sxs 5.2.3663.0 (main.020715-1506) 685.50 KB (701,952 bytes)
7/29/2002 1:58 PM Microsoft Corporation
c:\windows\system32\sxs.dll

winmm 5.2.3663.0 (main.020715-1506) 163.00 KB (166,912 bytes)
7/29/2002 2:04 PM Microsoft Corporation
c:\windows\system32\winmm.dll

shell32 6.00.3663.0 (main.020715-1506) 7.69 MB (8,067,072 bytes)
7/29/2002 1:56 PM Microsoft Corporation
c:\windows\system32\shell32.dll

rsaenh 5.2.3663.0 (main.020715-1506) 174.07 KB (178,248 bytes)
7/29/2002 1:51 PM Microsoft Corporation
c:\windows\system32\rsaenh.dll

wldap32 5.2.3663.0 (main.020715-1506) 167.00 KB (171,008 bytes)
7/29/2002 2:05 PM Microsoft Corporation
c:\windows\system32\wldap32.dll

cscdll 5.2.3663.0 (main.020715-1506) 92.50 KB (94,720 bytes)
7/29/2002 1:14 PM Microsoft Corporation
c:\windows\system32\cscdll.dll

wlnotify 5.2.3663.0 (main.020715-1506) 84.50 KB (86,528 bytes)
7/29/2002 2:05 PM Microsoft Corporation
c:\windows\system32\wlnotify.dll

winspool 5.2.3663.0 (main.020715-1506) 131.50 KB (134,656 bytes)
7/29/2002 2:05 PM Microsoft Corporation
c:\windows\system32\winspool.drv

mpr 5.2.3663.0 (main.020715-1506) 55.00 KB (56,320 bytes) 7/29/2002 1:30 PM
Microsoft Corporation c:\windows\system32\mpr.dll

comctl32 5.82 (main.020715-1506) 559.50 KB (572,928 bytes)
9/25/2002 6:55 AM Microsoft Corporation
c:\windows\winsxs\x86_microsoft.windows.common-
controls_6595b64144ccf1df_5.82.0.0_x-ww_8a69ba05\comctl32.dll

uxtheme 6.00.3663.0 (main.020715-1506) 190.50 KB (195,072 bytes)
7/29/2002 2:02 PM Microsoft Corporation
c:\windows\system32\uxtheme.dll

samlib 5.2.3663.0 (main.020715-1506) 40.50 KB (41,472 bytes)
7/29/2002 1:54 PM Microsoft Corporation
c:\windows\system32\samlib.dll

cscui 5.2.3663.0 (main.020715-1506) 299.00 KB (306,176 bytes)
7/29/2002 1:14 PM Microsoft Corporation
c:\windows\system32\cscui.dll

oleaut32 5.2.3663.0 483.50 KB (495,104 bytes) 7/29/2002 1:48 PM
Microsoft Corporation c:\windows\system32\oleaut32.dll

clbcatq 2001.12.4593.0 (main.020715-1506) 465.50 KB (476,672 bytes)
9/25/2002 12:04 PM Microsoft Corporation
c:\windows\system32\clbcatq.dll

comres 2001.12.4593.0 (main.020715-1506) 778.00 KB (796,672 bytes)
7/29/2002 1:14 PM Microsoft Corporation
c:\windows\system32\comres.dll

Appendix C – Tunable Parameters

ntmarta 5.2.3663.0 (main.020715-1506) 110.50 KB (113,152 bytes)
7/29/2002 1:36 PM Microsoft Corporation
c:\windows\system32\ntmarta.dll

wbemprox 5.2.3663.0 (main.020715-1506) 16.00 KB (16,384 bytes)
9/25/2002 12:04 PM Microsoft Corporation
c:\windows\system32\wbem\wbemprox.dll

wbemcomn 5.2.3663.0 (main.020715-1506) 205.00 KB (209,920 bytes)
9/25/2002 12:04 PM Microsoft Corporation
c:\windows\system32\wbem\wbemcomn.dll

wbemsvc 5.2.3663.0 (main.020715-1506) 42.50 KB (43,520 bytes)
9/25/2002 12:04 PM Microsoft Corporation
c:\windows\system32\wbem\wbemsvc.dll

fastprox 5.2.3663.0 (main.020715-1506) 434.50 KB (444,928 bytes)
9/25/2002 12:04 PM Microsoft Corporation
c:\windows\system32\wbem\fastprox.dll

msvcp60 6.05.2144.0 388.00 KB (397,312 bytes) 7/29/2002 1:33 PM
Microsoft Corporation c:\windows\system32\msvcp60.dll

ntdsapi 5.2.3663.0 (main.020715-1506) 67.00 KB (68,608 bytes)
7/29/2002 1:36 PM Microsoft Corporation
c:\windows\system32\ntdsapi.dll

dnsapi 5.2.3663.0 (main.020715-1506) 141.50 KB (144,896 bytes)
7/29/2002 1:16 PM Microsoft Corporation
c:\windows\system32\dnsapi.dll

services 5.2.3663.0 (main.020715-1506) 99.00 KB (101,376 bytes)
7/29/2002 1:55 PM Microsoft Corporation
c:\windows\system32\services.exe

scesrv 5.2.3663.0 (main.020715-1506) 301.00 KB (308,224 bytes)
7/29/2002 1:54 PM Microsoft Corporation
c:\windows\system32\scesrv.dll

umpnpgmr 5.2.3663.0 (main.020715-1506) 115.00 KB (117,760 bytes)
7/29/2002 2:01 PM Microsoft Corporation
c:\windows\system32\umpnpgmr.dll

ncobjapi 5.2.3663.0 (main.020715-1506) 33.00 KB (33,792 bytes)
7/29/2002 1:33 PM Microsoft Corporation
c:\windows\system32\ncobjapi.dll

eventlog 5.2.3663.0 (main.020715-1506) 58.50 KB (59,904 bytes)
7/29/2002 1:18 PM Microsoft Corporation
c:\windows\system32\eventlog.dll

lsass 5.2.3663.0 (main.020715-1506) 13.00 KB (13,312 bytes) 7/29/2002
1:27 PM Microsoft Corporation c:\windows\system32\lsass.exe

lsasrv 5.2.3663.0 (main.020715-1506) 711.00 KB (728,064 bytes)
7/29/2002 1:27 PM Microsoft Corporation
c:\windows\system32\lsasrv.dll

samsrv 5.2.3663.0 (main.020715-1506) 408.00 KB (417,792 bytes)
7/29/2002 1:54 PM Microsoft Corporation
c:\windows\system32\samsrv.dll

cryptdll 5.2.3663.0 (main.020715-1506) 30.00 KB (30,720 bytes)
7/29/2002 1:14 PM Microsoft Corporation
c:\windows\system32\cryptdll.dll

msprivs 5.2.3663.0 (main.020715-1506) 44.00 KB (45,056 bytes)
7/29/2002 1:32 PM Microsoft Corporation
c:\windows\system32\msprivs.dll

kerberos 5.2.3663.0 (main.020715-1506) 299.00 KB (306,176 bytes)
7/29/2002 1:25 PM Microsoft Corporation
c:\windows\system32\kerberos.dll

Appendix C – Tunable Parameters

msv1_0 5.2.3663.0 (main.020715-1506) 114.50 KB (117,248 bytes)
7/29/2002 1:33 PM Microsoft Corporation
c:\windows\system32\msv1_0.dll

netlogon 5.2.3663.0 (main.020715-1506) 401.50 KB (411,136 bytes)
7/29/2002 1:34 PM Microsoft Corporation
c:\windows\system32\netlogon.dll

w32time 5.2.3663.0 (main.020715-1506) 205.50 KB (210,432 bytes)
7/29/2002 2:02 PM Microsoft Corporation
c:\windows\system32\w32time.dll

iphlpapi 5.2.3663.0 (main.020715-1506) 80.50 KB (82,432 bytes)
7/29/2002 1:22 PM Microsoft Corporation
c:\windows\system32\iphlpapi.dll

schannel 5.2.3663.0 (main.020715-1506) 138.50 KB (141,824 bytes)
7/29/2002 1:54 PM Microsoft Corporation
c:\windows\system32\schannel.dll

wdigest 5.2.3663.0 (main.020715-1506) 59.50 KB (60,928 bytes)
7/29/2002 2:03 PM Microsoft Corporation
c:\windows\system32\wdigest.dll

rassfm 5.2.3663.0 (main.020715-1506) 20.50 KB (20,992 bytes)
7/29/2002 1:50 PM Microsoft Corporation
c:\windows\system32\rassfm.dll

kdcsvc 5.2.3663.0 (main.020715-1506) 190.50 KB (195,072 bytes)
7/29/2002 1:25 PM Microsoft Corporation
c:\windows\system32\kdcsvc.dll

ntdsa 5.2.3663.0 (main.020715-1506) 1.40 MB (1,465,344 bytes)
7/29/2002 1:36 PM Microsoft Corporation
c:\windows\system32\ntdsa.dll

ntdsatq 5.2.3663.0 (main.020715-1506) 27.50 KB (28,160 bytes)
7/29/2002 1:36 PM Microsoft Corporation
c:\windows\system32\ntdsatq.dll

mwssock 5.2.3663.0 (main.020715-1506) 243.50 KB (249,344 bytes)
7/29/2002 1:33 PM Microsoft Corporation
c:\windows\system32\mwssock.dll

esent 5.2.3663.0 (main.020715-1506) 925.50 KB (947,712 bytes)
7/29/2002 1:18 PM Microsoft Corporation
c:\windows\system32\esent.dll

certcli 5.2.3663.0 (main.020715-1506) 215.00 KB (220,160 bytes)
7/29/2002 1:10 PM Microsoft Corporation
c:\windows\system32\certcli.dll

atl 3.05.2144 82.00 KB (83,968 bytes) 7/29/2002 1:09 PM Microsoft Corporation
c:\windows\system32\atl.dll

cryptui 5.131.3663.0 (main.020715-1506) 463.50 KB (474,624 bytes)
7/29/2002 1:14 PM Microsoft Corporation
c:\windows\system32\cryptui.dll

scecli 5.2.3663.0 (main.020715-1506) 174.00 KB (178,176 bytes)
7/29/2002 1:54 PM Microsoft Corporation
c:\windows\system32\scecli.dll

dssenh 5.2.3663.0 (main.020715-1506) 129.07 KB (132,168 bytes)
7/29/2002 1:17 PM Microsoft Corporation
c:\windows\system32\dssenh.dll

svchost 5.2.3663.0 (main.020715-1506) 12.00 KB (12,288 bytes)
7/29/2002 1:58 PM Microsoft Corporation
c:\windows\system32\svchost.exe

Appendix C – Tunable Parameters

rpcss 5.2.3663.0 (main.020715-1506) 266.00 KB (272,384 bytes)
7/29/2002 1:51 PM Microsoft Corporation
c:\windows\system32\rpcss.dll

wshtcpip 5.2.3663.0 (main.020715-1506) 17.00 KB (17,408 bytes)
7/29/2002 2:07 PM Microsoft Corporation
c:\windows\system32\wshtcpip.dll

termsrv 5.2.3663.0 (main.020715-1506) 215.00 KB (220,160 bytes)
9/25/2002 12:04 PM Microsoft Corporation
c:\windows\system32\termsrv.dll

icaapi 5.2.3663.0 (main.020715-1506) 10.00 KB (10,240 bytes)
9/25/2002 12:04 PM Microsoft Corporation
c:\windows\system32\icaapi.dll

mstlsapi 5.2.3663.0 (main.020715-1506) 103.00 KB (105,472 bytes)
7/29/2002 1:33 PM Microsoft Corporation
c:\windows\system32\mstlsapi.dll

activeds 5.2.3663.0 (main.020715-1506) 184.50 KB (188,928 bytes)
7/29/2002 1:08 PM Microsoft Corporation
c:\windows\system32\activeds.dll

adslrpc 5.2.3663.0 (main.020715-1506) 139.50 KB (142,848 bytes)
7/29/2002 1:09 PM Microsoft Corporation
c:\windows\system32\adslrpc.dll

credui 5.2.3663.0 (main.020715-1506) 161.00 KB (164,864 bytes)
7/29/2002 1:14 PM Microsoft Corporation
c:\windows\system32\credui.dll

wkssvc 5.2.3663.0 (main.020715-1506) 122.00 KB (124,928 bytes)
7/29/2002 2:05 PM Microsoft Corporation
c:\windows\system32\wkssvc.dll

dmserver 5.2.3663.0 (main.020715-1506) 22.00 KB (22,528 bytes)
7/29/2002 1:16 PM Microsoft Corporation
c:\windows\system32\dmserver.dll

srvsvc 5.2.3663.0 (main.020715-1506) 87.50 KB (89,600 bytes)
7/29/2002 1:57 PM Microsoft Corporation
c:\windows\system32\srvsvc.dll

wmisvc 5.2.3663.0 (main.020715-1506) 113.50 KB (116,224 bytes)
9/25/2002 12:04 PM Microsoft Corporation
c:\windows\system32\wbem\wmisvc.dll

vssapi 5.2.3663.0 (main.020715-1506) 471.00 KB (482,304 bytes)
7/29/2002 2:02 PM Microsoft Corporation
c:\windows\system32\vssapi.dll

es 2001.12.4593.0 (main.020715-1506) 218.00 KB (223,232 bytes)
7/29/2002 1:18 PM Microsoft Corporation
c:\windows\system32\es.dll

sens 5.2.3663.0 (main.020715-1506) 35.00 KB (35,840 bytes) 7/29/2002
1:55 PM Microsoft Corporation c:\windows\system32\sens.dll

netman 5.2.3663.0 (main.020715-1506) 147.00 KB (150,528 bytes)
7/29/2002 1:34 PM Microsoft Corporation
c:\windows\system32\netman.dll

mprapi 5.2.3663.0 (main.020715-1506) 78.00 KB (79,872 bytes)
7/29/2002 1:30 PM Microsoft Corporation
c:\windows\system32\mprapi.dll

rtutils 5.2.3663.0 (main.020715-1506) 31.00 KB (31,744 bytes)
7/29/2002 1:52 PM Microsoft Corporation
c:\windows\system32\rtutils.dll

Appendix C – Tunable Parameters

rasapi32 5.2.3663.0 (main.020715-1506) 217.00 KB (222,208 bytes)
7/29/2002 1:50 PM Microsoft Corporation
c:\windows\system32\rasapi32.dll

rasman 5.2.3663.0 (main.020715-1506) 55.00 KB (56,320 bytes)
7/29/2002 1:50 PM Microsoft Corporation
c:\windows\system32\rasman.dll

tapi32 5.2.3663.0 (main.020715-1506) 169.50 KB (173,568 bytes)
7/29/2002 1:59 PM Microsoft Corporation
c:\windows\system32\tapi32.dll

wzcsvc 5.2.3663.0 (main.020715-1506) 271.00 KB (277,504 bytes)
7/16/2002 8:48 AM Microsoft Corporation
c:\windows\system32\wzcsvc.dll

wmi 5.2.3663.0 (main.020715-1506) 6.50 KB (6,656 bytes) 7/29/2002
2:05 PM Microsoft Corporation c:\windows\system32\wmi.dll

dhcpcsvc 5.2.3663.0 (main.020715-1506) 101.00 KB (103,424 bytes)
7/29/2002 1:16 PM Microsoft Corporation
c:\windows\system32\dhcpcsvc.dll

wzcsapi 5.2.3663.0 (main.020715-1506) 24.00 KB (24,576 bytes)
7/16/2002 8:48 AM Microsoft Corporation
c:\windows\system32\wzcsapi.dll

netshell 5.2.3663.0 (main.020715-1506) 1.57 MB (1,648,128 bytes)
7/29/2002 1:35 PM Microsoft Corporation
c:\windows\system32\netshell.dll

clusapi 5.2.3663.0 (main.020715-1506) 54.50 KB (55,808 bytes)
7/29/2002 1:11 PM Microsoft Corporation
c:\windows\system32\clusapi.dll

hnetcfg 5.2.3663.0 (main.020715-1506) 241.50 KB (247,296 bytes)
7/29/2002 1:20 PM Microsoft Corporation
c:\windows\system32\hnetcfg.dll

wininet 6.00.3663.0 (main.020715-1506) 581.00 KB (594,944
bytes) 7/29/2002 2:04 PM Microsoft Corporation
c:\windows\system32\wininet.dll

wbemcore 5.2.3663.0 (main.020715-1506) 448.50 KB (459,264 bytes)
9/25/2002 12:04 PM Microsoft Corporation
c:\windows\system32\wbem\wbemcore.dll

esscli 5.2.3663.0 (main.020715-1506) 232.00 KB (237,568 bytes)
9/25/2002 12:04 PM Microsoft Corporation
c:\windows\system32\wbem\esscli.dll

wmiutils 5.2.3663.0 (main.020715-1506) 88.50 KB (90,624 bytes)
9/25/2002 12:04 PM Microsoft Corporation
c:\windows\system32\wbem\wmiutils.dll

repdrvfs 5.2.3663.0 (main.020715-1506) 140.00 KB (143,360 bytes)
9/25/2002 12:04 PM Microsoft Corporation
c:\windows\system32\wbem\repdrvfs.dll

wmiprvsd 5.2.3663.0 (main.020715-1506) 403.50 KB (413,184 bytes)
9/25/2002 12:04 PM Microsoft Corporation
c:\windows\system32\wbem\wmiprvsd.dll

wbemess 5.2.3663.0 (main.020715-1506) 253.00 KB (259,072 bytes)
9/25/2002 12:04 PM Microsoft Corporation
c:\windows\system32\wbem\wbemess.dll

rasdlg 5.2.3663.0 (main.020715-1506) 637.00 KB (652,288 bytes)
7/29/2002 1:50 PM Microsoft Corporation
c:\windows\system32\rasdlg.dll

Appendix C – Tunable Parameters

ncprov 5.2.3663.0 (main.020715-1506) 42.50 KB (43,520 bytes)
9/25/2002 12:04 PM Microsoft Corporation
c:\windows\system32\wbem\ncprov.dll

pchsvc 5.2.3663.0 (main.020715-1506) 30.00 KB (30,720 bytes)
9/25/2002 12:08 PM Microsoft Corporation
c:\windows\pchealth\helpctr\binaries\pchsvc.dll

netcfgx 5.2.3663.0 (main.020715-1506) 616.00 KB (630,784 bytes)
7/29/2002 1:34 PM Microsoft Corporation
c:\windows\system32\netcfgx.dll

winipsec 5.2.3663.0 (main.020715-1506) 29.00 KB (29,696 bytes)
7/29/2002 2:04 PM Microsoft Corporation
c:\windows\system32\winipsec.dll

explorer 6.00.3663.0 (main.020715-1506) 989.50 KB (1,013,248 bytes)
7/29/2002 1:18 PM Microsoft Corporation
c:\windows\explorer.exe

browseui 6.00.3663.0 (main.020715-1506) 999.50 KB (1,023,488 bytes)
7/29/2002 1:10 PM Microsoft Corporation
c:\windows\system32\browseui.dll

shdocvw 6.00.3663.0 (main.020715-1506) 1.28 MB (1,341,952 bytes)
7/29/2002 1:55 PM Microsoft Corporation
c:\windows\system32\shdocvw.dll

apphelp 5.2.3663.0 (main.020715-1506) 117.00 KB (119,808 bytes)
7/29/2002 1:09 PM Microsoft Corporation
c:\windows\system32\apphelp.dll

themeui 6.00.3663.0 (main.020715-1506) 360.00 KB (368,640 bytes)
7/29/2002 1:59 PM Microsoft Corporation
c:\windows\system32\themeui.dll

msimg32 5.2.3663.0 (main.020715-1506) 4.50 KB (4,608 bytes)
7/29/2002 1:32 PM Microsoft Corporation
c:\windows\system32\msimg32.dll

linkinfo 5.2.3663.0 (main.020715-1506) 15.50 KB (15,872 bytes)
7/29/2002 1:27 PM Microsoft Corporation
c:\windows\system32\linkinfo.dll

ntshrui 6.00.3663.0 (main.020715-1506) 134.50 KB (137,728 bytes)
7/29/2002 1:36 PM Microsoft Corporation
c:\windows\system32\ntshrui.dll

urlmon 6.00.3663.0 (main.020715-1506) 442.00 KB (452,608 bytes)
7/29/2002 2:01 PM Microsoft Corporation
c:\windows\system32\urlmon.dll

webcheck 6.00.3663.0 (main.020715-1506) 253.50 KB (259,584 bytes)
7/29/2002 2:04 PM Microsoft Corporation
c:\windows\system32\webcheck.dll

wsock32 5.2.3663.0 (main.020715-1506) 22.00 KB (22,528 bytes)
7/29/2002 2:07 PM Microsoft Corporation
c:\windows\system32\wsock32.dll

stobject 5.2.3663.0 (main.020715-1506) 116.50 KB (119,296 bytes)
7/29/2002 1:58 PM Microsoft Corporation
c:\windows\system32\stobject.dll

batmeter 6.00.3663.0 (main.020715-1506) 28.00 KB (28,672 bytes)
7/29/2002 1:10 PM Microsoft Corporation
c:\windows\system32\batmeter.dll

powrprof 6.00.3663.0 (main.020715-1506) 14.00 KB (14,336 bytes)
7/29/2002 1:49 PM Microsoft Corporation
c:\windows\system32\powrprof.dll

Appendix C – Tunable Parameters

```
printui      5.2.3663.0 (main.020715-1506) 522.00 KB (534,528 bytes)
              7/29/2002 1:49 PM Microsoft Corporation
              c:\windows\system32\printui.dll
cfgmgr32     5.2.3663.0 (main.020715-1506) 17.00 KB (17,408 bytes)
              7/29/2002 1:11 PM Microsoft Corporation
              c:\windows\system32\cfgmgr32.dll
drprov       5.2.3663.0 (main.020715-1506) 12.00 KB (12,288 bytes)
              7/29/2002 1:17 PM Microsoft Corporation
              c:\windows\system32\drprov.dll
ntlanman     5.2.3663.0 (main.020715-1506) 39.50 KB (40,448 bytes)
              7/29/2002 1:36 PM Microsoft Corporation
              c:\windows\system32\ntlanman.dll
netui0       5.2.3663.0 (main.020715-1506) 73.00 KB (74,752 bytes)
              7/29/2002 1:35 PM Microsoft Corporation
              c:\windows\system32\netui0.dll
netuil       5.2.3663.0 (main.020715-1506) 176.50 KB (180,736 bytes)
              7/29/2002 1:35 PM Microsoft Corporation
              c:\windows\system32\netuil.dll
davclnt      5.2.3663.0 (main.020715-1506) 23.00 KB (23,552 bytes)
              7/29/2002 1:15 PM Microsoft Corporation
              c:\windows\system32\davclnt.dll
browselc     6.00.3663.0 (main.020715-1506)      61.50 KB (62,976 bytes)
              7/29/2002 1:10 PM Microsoft Corporation
              c:\windows\system32\browselc.dll
shdoclc      6.00.3663.0 (main.020715-1506)      521.00 KB (533,504
bytes)       7/29/2002 1:55 PM Microsoft Corporation
              c:\windows\system32\shdoclc.dll
mydocs       6.00.3663.0 (main.020715-1506)      87.00 KB (89,088 bytes)
              7/29/2002 1:33 PM Microsoft Corporation
              c:\windows\system32\mydocs.dll
zipfldr      6.00.3663.0 (main.020715-1506)      314.50 KB (322,048
bytes)       7/29/2002 2:07 PM Microsoft Corporation
              c:\windows\system32\zipfldr.dll
wzshlstb     3.0 (32-bit)      24.07 KB (24,644 bytes) 11/22/2000 7:00
AM WinZip Computing, Inc. c:\progra~1\winzip\wzshlstb.dll
sendmail     6.00.3663.0 (main.020715-1506)      54.00 KB (55,296 bytes)
              7/29/2002 1:55 PM Microsoft Corporation
              c:\windows\system32\sendmail.dll
srchui       1.00 708.06 KB (725,054 bytes)      9/25/2002 12:09 PM
Microsoft Corporation c:\windows\srchasst\srchui.dll
msacm32      5.2.3663.0 (main.020715-1506) 66.00 KB (67,584 bytes)
              7/29/2002 1:31 PM Microsoft Corporation
              c:\windows\system32\msacm32.dll
oleacc       4.2.5406.0 (main.020715-1506) 164.50 KB (168,448 bytes)
              7/29/2002 1:48 PM Microsoft Corporation
              c:\windows\system32\oleacc.dll
msi          2.0.3663.0 1.97 MB (2,067,456 bytes)      7/29/2002 1:32 PM
Microsoft Corporation c:\windows\system32\msi.dll
srchctls     1.00 57.06 KB (58,434 bytes) 9/25/2002 12:09 PM
Microsoft Corporation c:\windows\srchasst\srchctls.dll
msxml3       8.40.8806.0 1.06 MB (1,107,968 bytes)      7/29/2002 1:33 PM
Microsoft Corporation c:\windows\system32\msxml3.dll
sensapi      5.2.3663.0 (main.020715-1506) 6.00 KB (6,144 bytes)
              7/29/2002 1:55 PM Microsoft Corporation
              c:\windows\system32\sensapi.dll
```

Appendix C – Tunable Parameters

jscrip 5.6.0.7727 412.00 KB (421,888 bytes) 7/29/2002 1:24 PM
Microsoft Corporation c:\windows\system32\jscrip.dll

winrnr 5.2.3663.0 (main.020715-1506) 14.50 KB (14,848 bytes)
7/29/2002 2:05 PM Microsoft Corporation
c:\windows\system32\winrnr.dll

rasadhlp 5.2.3663.0 (main.020715-1506) 6.00 KB (6,144 bytes)
7/29/2002 1:50 PM Microsoft Corporation
c:\windows\system32\rasadhlp.dll

query 5.2.3663.0 (main.020715-1506) 1.28 MB (1,344,512 bytes)
7/29/2002 1:50 PM Microsoft Corporation
c:\windows\system32\query.dll

offfilt 2002, 5, 18, 0 107.50 KB (110,080 bytes) 7/29/2002
1:48 PM Microsoft Corporation c:\windows\system32\offfilt.dll

nlhtml 7.0.1315.0 89.00 KB (91,136 bytes) 7/29/2002 1:35 PM
Microsoft Corporation c:\windows\system32\nlhtml.dll

mlang 6.00.3663.0 (main.020715-1506) 564.50 KB (578,048 bytes)
7/29/2002 1:29 PM Microsoft Corporation
c:\windows\system32\mlang.dll

mscoree 1.0.3705.0 128.00 KB (131,072 bytes) 9/25/2002 12:05
PM Microsoft Corporation c:\windows\system32\mscoree.dll

shfusion 1.0.3705.0 244.00 KB (249,856 bytes) 9/25/2002 12:05
PM Microsoft Corporation
c:\windows\microsoft.net\framework\v1.0.3705\shfusion.dll

msvcr70 7.00.9466.0 336.00 KB (344,064 bytes) 9/25/2002 12:05
PM Microsoft Corporation
c:\windows\microsoft.net\framework\v1.0.3705\msvcr70.dll

shmedia 6.00.3663.0 (main.020715-1506) 125.00 KB (128,000
bytes) 7/29/2002 1:56 PM Microsoft Corporation
c:\windows\system32\shmedia.dll

msvfw32 5.2.3663.0 (main.020715-1506) 112.00 KB (114,688 bytes)
7/29/2002 1:33 PM Microsoft Corporation
c:\windows\system32\msvfw32.dll

avifil32 5.2.3663.0 (main.020715-1506) 76.50 KB (78,336 bytes)
7/29/2002 1:09 PM Microsoft Corporation
c:\windows\system32\avifil32.dll

tssoft32 1.01 9.50 KB (9,728 bytes) 7/29/2002 2:00 PM DSP GROUP,
INC. c:\windows\system32\tssoft32.acm

tsd32 1.03 16.50 KB (16,896 bytes) 7/29/2002 2:00 PM DSP GROUP, INC.
c:\windows\system32\tsd32.dll

mstask 5.2.3663.0 (main.020715-1506) 277.50 KB (284,160 bytes)
9/25/2002 12:08 PM Microsoft Corporation
c:\windows\system32\mstask.dll

comdlg32 6.00.3663.0 (main.020715-1506) 255.00 KB (261,120
bytes) 7/29/2002 1:11 PM Microsoft Corporation
c:\windows\system32\comdlg32.dll

msadp32 5.2.3663.0 (main.020715-1506) 14.50 KB (14,848 bytes)
7/29/2002 1:31 PM Microsoft Corporation
c:\windows\system32\msadp32.acm

wmvcore 8.00.00.4477 1.16 MB (1,216,512 bytes) 7/29/2002
2:06 PM Microsoft Corporation c:\windows\system32\wmvcore.dll

wmasf 8.00.00.4477 268.00 KB (274,432 bytes) 7/29/2002 2:05 PM
Microsoft Corporation c:\windows\system32\wmasf.dll

actxprxy 6.00.3663.0 (main.020715-1506) 95.00 KB (97,280 bytes)
7/29/2002 1:08 PM Microsoft Corporation
c:\windows\system32\actxprxy.dll

Appendix C – Tunable Parameters

mmc 5.2.3663.0 (main.020715-1506) 758.00 KB (776,192 bytes)
7/29/2002 1:29 PM Microsoft Corporation
c:\windows\system32\mmc.exe

mfc42u 6.05.2178.0 960.00 KB (983,040 bytes) 7/29/2002 1:29 PM
Microsoft Corporation c:\windows\system32\mfc42u.dll

mmcbase 5.2.3663.0 (main.020715-1506) 68.00 KB (69,632 bytes)
7/29/2002 1:29 PM Microsoft Corporation
c:\windows\system32\mmcbase.dll

mmcndmgr 5.2.3663.0 (main.020715-1506) 1.08 MB (1,136,640 bytes)
7/29/2002 1:29 PM Microsoft Corporation
c:\windows\system32\mmcndmgr.dll

mycomput 5.2.3663.0 (main.020715-1506) 91.00 KB (93,184 bytes)
7/29/2002 1:33 PM Microsoft Corporation
c:\windows\system32\mycomput.dll

ntmsmgr 5.2.3663.0 (main.020715-1506) 475.50 KB (486,912 bytes)
7/29/2002 1:36 PM Microsoft Corporation
c:\windows\system32\ntmsmgr.dll

ntmsapi 5.2.3663.0 (main.020715-1506) 42.00 KB (43,008 bytes)
7/29/2002 1:36 PM Microsoft Corporation
c:\windows\system32\ntmsapi.dll

dfrgsnap 5.2.3663.0 (main.020715-1506) 36.00 KB (36,864 bytes)
7/29/2002 1:16 PM Microsoft Corp. and Executive Software
International, Inc. c:\windows\system32\dfrgsnap.dll

dfrgres 5.2.3663.0 (main.020715-1506) 50.50 KB (51,712 bytes)
7/29/2002 1:16 PM Microsoft Corp. and Executive Software
International, Inc. c:\windows\system32\dfrgres.dll

dmtdskmgr 5.2.3663.0 (main.020715-1506) 153.50 KB (157,184 bytes)
7/29/2002 1:16 PM Microsoft Corporation
c:\windows\system32\dmtdskmgr.dll

dmutil 5.2.3663.0 (main.020715-1506) 50.50 KB (51,712 bytes)
7/16/2002 8:46 AM Microsoft Corporation
c:\windows\system32\dmutil.dll

dmtdskres 5.2.3663.0 (main.020715-1506) 116.00 KB (118,784 bytes)
7/29/2002 1:16 PM Microsoft Corporation
c:\windows\system32\dmtdskres.dll

els 5.2.3663.0 (main.020715-1506) 168.00 KB (172,032 bytes)
7/29/2002 1:17 PM Microsoft Corporation
c:\windows\system32\els.dll

riched32 5.2.3663.0 (main.020715-1506) 3.50 KB (3,584 bytes)
7/29/2002 1:51 PM Microsoft Corporation
c:\windows\system32\riched32.dll

riched20 5.31.23.1217 394.50 KB (403,968 bytes) 7/29/2002
1:51 PM Microsoft Corporation c:\windows\system32\riched20.dll

filemgmt 5.2.3663.0 (main.020715-1506) 313.50 KB (321,024 bytes)
7/29/2002 1:18 PM Microsoft Corporation
c:\windows\system32\filemgmt.dll

localsec 5.2.3663.0 (main.020715-1506) 206.00 KB (210,944 bytes)
7/29/2002 1:27 PM Microsoft Corporation
c:\windows\system32\localsec.dll

adsnt 5.2.3663.0 (main.020715-1506) 236.50 KB (242,176 bytes)
7/29/2002 1:09 PM Microsoft Corporation
c:\windows\system32\adsnt.dll

smlogcfg 5.2.3663.0 (main.020715-1506) 333.00 KB (340,992 bytes)
7/29/2002 1:57 PM Microsoft Corporation
c:\windows\system32\smlogcfg.dll

Appendix C – Tunable Parameters

pdh 5.2.3663.0 (main.020715-1506) 262.00 KB (268,288 bytes)
7/29/2002 1:49 PM Microsoft Corporation
c:\windows\system32\pdh.dll

odbc32 3.520.8713.0 212.00 KB (217,088 bytes) 7/29/2002
1:47 PM Microsoft Corporation c:\windows\system32\odbc32.dll

odbcbcsp 2000.081.8713.02 24.00 KB (24,576 bytes) 7/29/2002 1:47 PM
Microsoft Corporation c:\windows\system32\odbcbcsp.dll

odbcint 3.520.8713.0 92.00 KB (94,208 bytes) 7/29/2002 1:47 PM
Microsoft Corporation c:\windows\system32\odbcint.dll

devmgr 5.2.3663.0 (main.020715-1506) 263.00 KB (269,312 bytes)
7/29/2002 1:15 PM Microsoft Corporation
c:\windows\system32\devmgr.dll

dmdlgs 5.2.3663.0 (main.020715-1506) 271.00 KB (277,504 bytes)
7/29/2002 1:16 PM Microsoft Corporation
c:\windows\system32\dmdlgs.dll

dmview 5.2.3663.0 (main.020715-1506) 61.50 KB (62,976 bytes)
7/29/2002 1:16 PM Microsoft Corporation
c:\windows\system32\dmview.ocx

vds_ps 5.2.3663.0 (main.020715-1506) 21.00 KB (21,504 bytes)
7/29/2002 2:02 PM Microsoft Corporation
c:\windows\system32\vds_ps.dll

dmivcitf 5.2.3663.0 (main.020715-1506) 50.00 KB (51,200 bytes)
7/29/2002 1:16 PM Microsoft Corporation
c:\windows\system32\dmivcitf.dll

dmintf 5.2.3663.0 (main.020715-1506) 19.50 KB (19,968 bytes)
7/29/2002 1:16 PM Microsoft Corporation
c:\windows\system32\dmintf.dll

dmremote 5.2.3663.0 (main.020715-1506) 14.50 KB (14,848 bytes)
7/29/2002 1:16 PM Microsoft Corporation
c:\windows\system32\dmremote.exe

dmadmin 5.2.3663.0 (main.020715-1506) 212.00 KB (217,088 bytes)
7/29/2002 1:16 PM Microsoft Corporation
c:\windows\system32\dmadmin.exe

osuninst 5.2.3663.0 (main.020715-1506) 114.50 KB (117,248 bytes)
7/29/2002 1:48 PM Microsoft Corporation
c:\windows\system32\osuninst.dll

cabinet 5.2.3663.0 (main.020715-1506) 54.00 KB (55,296 bytes)
7/29/2002 1:10 PM Microsoft Corporation
c:\windows\system32\cabinet.dll

fmifs 5.2.3663.0 (main.020715-1506) 17.00 KB (17,408 bytes) 7/29/2002
1:19 PM Microsoft Corporation c:\windows\system32\fmifs.dll

ulib 5.2.3663.0 (main.020715-1506) 265.00 KB (271,360 bytes)
7/29/2002 2:00 PM Microsoft Corporation
c:\windows\system32\ulib.dll

ifsutil 5.2.3663.0 (main.020715-1506) 71.50 KB (73,216 bytes)
7/29/2002 1:22 PM Microsoft Corporation
c:\windows\system32\ifsutil.dll

cmd 5.2.3663.0 (main.020715-1506) 371.00 KB (379,904 bytes)
7/29/2002 1:11 PM Microsoft Corporation
c:\windows\system32\cmd.exe

sqlservr 2000.080.0731.00 7.17 MB (7,516,244 bytes) 12/12/2002
12:10 PM Microsoft Corporation c:\program files\microsoft sql
server\mssql\bin\sqlservr.exe

Appendix C – Tunable Parameters

opens60 2000.080.0194.00 24.06 KB (24,639 bytes) 12/12/2002 12:10 PM
Microsoft Corporation c:\program files\microsoft sql server\mssql\bin\opens60.dll

ums 2000.080.0731.00 52.55 KB (53,808 bytes) 12/12/2002 12:10 PM
Microsoft Corporation c:\program files\microsoft sql server\mssql\bin\ums.dll

sqlsort 2000.080.0731.00 576.56 KB (590,396 bytes) 12/12/2002 12:10 PM
Microsoft Corporation c:\program files\microsoft sql server\mssql\bin\sqlsort.dll

msvcirt 7.0.3663.0 (main.020715-1506) 49.50 KB (50,688 bytes) 7/29/2002 1:33 PM
Microsoft Corporation c:\windows\system32\msvcirt.dll

sqlevn70 2000.080.0731.00 28.00 KB (28,672 bytes) 12/12/2002 12:10 PM
Microsoft Corporation c:\program files\microsoft sql server\mssql\bin\resources\1033\sqlevn70.rll

xolehlp 2001.12.4593.0 (main.020715-1506) 8.00 KB (8,192 bytes) 9/25/2002 12:04 PM
Microsoft Corporation c:\windows\system32\xolehlp.dll

msdtcprx 2001.12.4593.0 (main.020715-1506) 405.50 KB (415,232 bytes) 9/25/2002 12:04 PM
Microsoft Corporation c:\windows\system32\msdtcprx.dll

mtxclu 2001.12.4593.0 (main.020715-1506) 72.50 KB (74,240 bytes) 7/29/2002 1:33 PM
Microsoft Corporation c:\windows\system32\mtxclu.dll

resutils 5.2.3663.0 (main.020715-1506) 56.00 KB (57,344 bytes) 7/29/2002 1:51 PM
Microsoft Corporation c:\windows\system32\resutils.dll

ssnetlib 2000.080.0731.00 80.56 KB (82,492 bytes) 12/12/2002 12:10 PM
Microsoft Corporation c:\program files\microsoft sql server\mssql\bin\ssnetlib.dll

ssnmpn70 2000.080.0534.00 24.56 KB (25,148 bytes) 12/12/2002 12:10 PM
Microsoft Corporation c:\program files\microsoft sql server\mssql\bin\ssnmpn70.dll

security 5.2.3663.0 (main.020715-1506) 5.00 KB (5,120 bytes) 7/29/2002 1:55 PM
Microsoft Corporation c:\windows\system32\security.dll

ssmslpcn 2000.080.0731.00 28.56 KB (29,244 bytes) 12/12/2002 12:10 PM
Microsoft Corporation c:\program files\microsoft sql server\mssql\bin\ssmslpcn.dll

notepad 5.2.3663.0 (main.020715-1506) 66.00 KB (67,584 bytes) 7/29/2002 1:35 PM
Microsoft Corporation c:\windows\system32\notepad.exe

helpctr 5.2.3663.0 (main.020715-1506) 670.00 KB (686,080 bytes) 9/25/2002 12:08 PM
Microsoft Corporation c:\windows\pchealth\helpctr\binaries\helpctr.exe

hcappres 5.2.3663.0 (main.020715-1506) 6.50 KB (6,656 bytes) 9/25/2002 12:08 PM
Microsoft Corporation c:\windows\pchealth\helpctr\binaries\hcappres.dll

itss 5.2.3663.0 (main.020715-1506) 118.50 KB (121,344 bytes) 7/29/2002 1:24 PM
Microsoft Corporation c:\windows\system32\itss.dll

pchshell 5.2.3663.0 (main.020715-1506) 94.00 KB (96,256 bytes) 9/25/2002 12:08 PM
Microsoft Corporation c:\windows\pchealth\helpctr\binaries\pchshell.dll

Appendix C – Tunable Parameters

```

mshtml      6.00.3663.0 (main.020715-1506)      2.57 MB (2,690,560
bytes)      7/29/2002 1:32 PM Microsoft Corporation
             c:\windows\system32\mshtml.dll
msimtf      5.2.3663.0 (main.020715-1506) 141.00 KB (144,384 bytes)
             7/29/2002 1:32 PM Microsoft Corporation
             c:\windows\system32\msimtf.dll
msctf       5.2.3663.0 (main.020715-1506) 273.00 KB (279,552 bytes)
             7/29/2002 1:31 PM Microsoft Corporation
             c:\windows\system32\msctf.dll
msls31      3.10.349.0 137.00 KB (140,288 bytes)      7/29/2002 1:32 PM
Microsoft Corporation c:\windows\system32\msls31.dll
imm32       5.2.3663.0 (main.020715-1506) 104.00 KB (106,496 bytes)
             7/29/2002 1:22 PM Microsoft Corporation
             c:\windows\system32\imm32.dll
mshtmlmed   6.00.3663.0 (main.020715-1506)      424.00 KB (434,176
bytes)      7/29/2002 1:32 PM Microsoft Corporation
             c:\windows\system32\mshtmlmed.dll
vbscript    5.6.0.7727 388.00 KB (397,312 bytes)      7/29/2002 2:02 PM
Microsoft Corporation c:\windows\system32\vbscript.dll
mfc42       6.05.2178.0 960.00 KB (983,040 bytes)      7/29/2002 1:29 PM
Microsoft Corporation c:\windows\system32\mfc42.dll
msinfo      5.2.3663.0 (main.020715-1506) 352.00 KB (360,448 bytes)
             9/25/2002 12:08 PM Microsoft Corporation
             c:\windows\pchealth\helpctr\binaries\msinfo.dll
helpsvc     5.2.3663.0 (main.020715-1506) 683.50 KB (699,904 bytes)
             9/25/2002 12:08 PM Microsoft Corporation
             c:\windows\pchealth\helpctr\binaries\helpsvc.exe

```

[Services]

Display Name	Name	State	Start Mode	Service Type	Path	Error
Control	Start Name	Tag ID				
Alerter	Alerter	Stopped	Disabled	Share Process	c:\windows\system32\svchost.exe -k localservice	NT
AUTHORITY\LocalService	0					
Application Layer Gateway Service	ALG	Stopped	Manual	Own	c:\windows\system32\alg.exe	NT
Process						
AUTHORITY\LocalService	0					
Application Management	AppMgmt	Stopped	Manual	Share	c:\windows\system32\svchost.exe -k netsvcs	Normal
Process						
LocalSystem	0					
Windows Audio	AudioSrv	Stopped	Disabled	Share Process	c:\windows\system32\svchost.exe -k netsvcs	Normal
LocalSystem	0					
Background Intelligent Transfer Service	BITS	Stopped	Manual	Manual	c:\windows\system32\svchost.exe -k netsvcs	Normal
Share Process						
Normal	LocalSystem	0				
Computer Browser	Browser	Stopped	Manual	Share Process	c:\windows\system32\svchost.exe -k netsvcs	Normal
LocalSystem	0					
Indexing Service	CiSvc	Stopped	Manual	Share Process	c:\windows\system32\cisvc.exe	Normal
LocalSystem	0					
ClipBook	ClipSrv	Stopped	Disabled	Own Process	c:\windows\system32\clipsrv.exe	Normal
LocalSystem	0					

Appendix C – Tunable Parameters

```

COM+ System Application COMSysApp Stopped Manual Own Process
    c:\windows\system32\dllhost.exe /processid:{02d4b3f1-fd88-11d1-
960d-00805fc79235} Normal LocalSystem 0
Cryptographic Services CryptSvc Stopped Disabled Share
Process c:\windows\system32\svchost.exe -k netsvcs Normal
LocalSystem 0
Distributed File System Dfs Stopped Manual Own Process
    c:\windows\system32\dfssvc.exe Normal LocalSystem 0
DHCP Client Dhcp Stopped Manual Share Process
    c:\windows\system32\svchost.exe -k networkservice Normal
NT AUTHORITY\NetworkService 0
Logical Disk Manager Administrative Service dmadmin Running
Manual Share Process c:\windows\system32\dmadmin.exe
/com Normal LocalSystem 0
Logical Disk Manager dmserver Running Auto Share Process
    c:\windows\system32\svchost.exe -k netsvcs Normal
LocalSystem 0
DNS Client Dnscache Stopped Manual Share Process
    c:\windows\system32\svchost.exe -k networkservice Normal
NT AUTHORITY\NetworkService 0
Error Reporting Service ERSvc Stopped Manual Share Process
    c:\windows\system32\svchost.exe -k netsvcs Ignore
LocalSystem 0
Event Log Eventlog Running Auto Share Process
    c:\windows\system32\services.exe Normal LocalSystem 0
COM+ Event System EventSystem Running Manual Share Process
    c:\windows\system32\svchost.exe -k netsvcs Normal
LocalSystem 0
Help and Support helpsvc Running Manual Share Process
    c:\windows\system32\svchost.exe -k netsvcs Normal
LocalSystem 0
Human Interface Device Access HidServ Stopped Disabled Share
Process c:\windows\system32\svchost.exe -k netsvcs Normal
LocalSystem 0
HTTP SSL HTTPFilter Stopped Manual Share Process
    c:\windows\system32\lsass.exe Normal LocalSystem 0
IMAPI CD-Burning COM Service ImapiService Stopped Disabled
Own Process "c:\windows\system32\imapi.exe" Normal
LocalSystem 0
Intersite Messaging IsmServ Stopped Disabled Own Process
    c:\windows\system32\ismserv.exe Normal LocalSystem 0
Kerberos Key Distribution Center kdc Stopped Disabled Share
Process c:\windows\system32\lsass.exe Normal LocalSystem 0
Server lanmanserver Running Auto Share Process
    c:\windows\system32\svchost.exe -k netsvcs Normal
LocalSystem 0
Workstation lanmanworkstation Running Auto Share Process
    c:\windows\system32\svchost.exe -k netsvcs Normal
LocalSystem 0
License Logging LicenseService Stopped Manual Own Process
    c:\windows\system32\llssrv.exe Normal NT
AUTHORITY\NetworkService 0
TCP/IP NetBIOS Helper LmHosts Stopped Manual Share
Process c:\windows\system32\svchost.exe -k localservice Normal
NT AUTHORITY\LocalService 0

```

Appendix C – Tunable Parameters

```

Messenger Messenger Stopped Disabled Share Process
    c:\windows\system32\svchost.exe -k netsvcs Normal
    LocalSystem 0
NetMeeting Remote Desktop Sharing mnmsrvc Stopped Disabled
    Own Process c:\windows\system32\mnmsrvc.exe Normal
    LocalSystem 0
Distributed Transaction Coordinator MSDTC Running Auto Own Process
    c:\windows\system32\msdtc.exe Normal NT
AUTHORITY\NetworkService 0
Windows Installer MSIServer Stopped Manual Share Process
    c:\windows\system32\msiexec.exe /v Normal LocalSystem 0
MSSQLSERVER MSSQLSERVER Stopped Manual Own Process
    c:\progra~1\microso~1\mssql\bin\sqlservr.exe Normal
    LocalSystem 0
MSSQLServerADHelper MSSQLServerADHelper Stopped Manual
    Own Process c:\program files\microsoft sql
server\80\tools\bin\sqladhlp.exe Normal LocalSystem 0
Network DDE NetDDE Stopped Disabled Share Process
    c:\windows\system32\netdde.exe Normal LocalSystem 0
Network DDE DSDM NetDDEdsdm Stopped Disabled Share Process
    c:\windows\system32\netdde.exe Normal LocalSystem 0
Net Logon Netlogon Stopped Manual Share Process
    c:\windows\system32\lsass.exe Normal LocalSystem 0
Network Connections Netman Running Manual Share
Process c:\windows\system32\svchost.exe -k netsvcs Normal
    LocalSystem 0
Network Location Awareness (NLA) Nla Stopped Disabled Share
Process c:\windows\system32\svchost.exe -k netsvcs Normal
    LocalSystem 0
File Replication NtFrs Stopped Manual Own Process
    c:\windows\system32\ntfrs.exe Ignore LocalSystem 0
NT LM Security Support Provider NtLmSsp Stopped Disabled
Share Process c:\windows\system32\lsass.exe Normal
    LocalSystem 0
Removable Storage NtmsSvc Stopped Manual Share Process
    c:\windows\system32\svchost.exe -k netsvcs Normal
    LocalSystem 0
Plug and Play PlugPlay Running Auto Share Process
    c:\windows\system32\services.exe Normal LocalSystem 0
IPSEC Services PolicyAgent Stopped Manual Share Process
    c:\windows\system32\lsass.exe Normal LocalSystem 0
Protected Storage ProtectedStorage Stopped Manual Share
Process c:\windows\system32\lsass.exe Normal LocalSystem 0
Remote Access Auto Connection Manager RasAuto Stopped
Manual Share Process c:\windows\system32\svchost.exe -k
netsvcs Normal LocalSystem 0
Remote Access Connection Manager RasMan Stopped Manual
Share Process c:\windows\system32\svchost.exe -k netsvcs
Normal LocalSystem 0
Remote Desktop Help Session Manager RDSessMgr Stopped Manual
Own Process c:\windows\system32\sessmgr.exe Normal
    LocalSystem 0
Routing and Remote Access RemoteAccess Stopped Disabled
Share Process c:\windows\system32\svchost.exe -k netsvcs
Normal LocalSystem 0

```

Appendix C – Tunable Parameters

```

Remote Registry RemoteRegistry Stopped Manual Share
Process c:\windows\system32\svchost.exe -k regsvc Normal NT
AUTHORITY\LocalService 0
Remote Procedure Call (RPC) Locator RpcLocator Stopped Manual
Own Process c:\windows\system32\locator.exe Normal NT
AUTHORITY\NetworkService 0
Remote Procedure Call (RPC) RpcSs Running Auto Share Process
c:\windows\system32\svchost -k rpcss Normal LocalSystem
0
Resultant Set of Policy Provider RSoPProv Stopped Manual
Share Process c:\windows\system32\rsopprov.exe Normal
LocalSystem 0
Special Administration Console Helper sacsvr Stopped
Manual Share Process c:\windows\system32\svchost.exe -k
netsvcs Normal LocalSystem 0
Security Accounts Manager SamSs Running Auto Share Process
c:\windows\system32\lsass.exe Normal LocalSystem 0
Smart Card SCardSvr Stopped Manual Share Process
c:\windows\system32\scardsvr.exe Ignore NT
AUTHORITY\LocalService 0
Task Scheduler Schedule Stopped Manual Share Process
c:\windows\system32\svchost.exe -k netsvcs Normal
LocalSystem 0
Secondary Logon seclogon Stopped Manual Share Process
c:\windows\system32\svchost.exe -k netsvcs Ignore
LocalSystem 0
System Event Notification SENS Running Manual Share
Process c:\windows\system32\svchost.exe -k netsvcs Normal
LocalSystem 0
Internet Connection Firewall (ICF) / Internet Connection Sharing (ICS)
SharedAccess Stopped Disabled Share Process
c:\windows\system32\svchost.exe -k netsvcs Normal
LocalSystem 0
Shell Hardware Detection ShellHWDetection Stopped Manual
Share Process c:\windows\system32\svchost.exe -k netsvcs
Ignore LocalSystem 0
Print Spooler Spooler Stopped Manual Own Process
c:\windows\system32\spoolsv.exe Normal LocalSystem 0
SQLSERVERAGENT SQLSERVERAGENT Stopped Manual Own Process
c:\progra~1\microso~1\mssql\bin\sqlagent.exe Normal
LocalSystem 0
Windows Image Acquisition (WIA) stisvc Stopped Disabled
Share Process c:\windows\system32\svchost.exe -k imgsvc
Normal NT AUTHORITY\LocalService 0
Microsoft Software Shadow Copy Provider swprv Stopped Manual
Own Process c:\windows\system32\svchost.exe -k swprv Normal
LocalSystem 0
Performance Logs and Alerts SysmonLog Stopped Auto Own Process
c:\windows\system32\smlogsvc.exe Normal NT
Authority\NetworkService 0
Telephony TapiSrv Stopped Manual Share Process
c:\windows\system32\svchost.exe -k tapisrv Normal
LocalSystem 0

```

Appendix C – Tunable Parameters

```

Terminal Services TermService Running Manual Share Process
c:\windows\system32\svchost.exe -k termsvcs Normal
LocalSystem 0
Themes Themes Stopped Disabled Share Process
c:\windows\system32\svchost.exe -k netsvcs Normal
LocalSystem 0
Telnet TlntSvr Stopped Disabled Own Process
c:\windows\system32\tlntsvr.exe Normal NT
AUTHORITY\LOCAL SERVICE 0
Distributed Link Tracking Server TrkSvr Stopped Disabled
Share Process c:\windows\system32\svchost.exe -k netsvcs
Normal LocalSystem 0
Distributed Link Tracking Client TrkWks Stopped Manual
Share Process c:\windows\system32\svchost.exe -k netsvcs
Normal LocalSystem 0
Terminal Services Session Directory Tssdis Stopped Disabled
Own Process c:\windows\system32\tssdis.exe Normal
LocalSystem 0
Upload Manager uploadmgr Stopped Disabled Share Process
c:\windows\system32\svchost.exe -k netsvcs Normal
LocalSystem 0
Uninterruptible Power Supply UPS Stopped Manual Own Process
c:\windows\system32\ups.exe Normal LocalSystem 0
Virtual Disk Service vds Stopped Disabled Own Process
c:\windows\system32\vds.exe Normal LocalSystem 0
Volume Shadow Copy VSS Stopped Manual Own Process
c:\windows\system32\vssvc.exe Normal LocalSystem 0
Windows Time W32Time Stopped Manual Share Process
c:\windows\system32\svchost.exe -k netsvcs Normal
LocalSystem 0
WebClient WebClient Stopped Disabled Share Process
c:\windows\system32\svchost.exe -k localservice Normal NT
AUTHORITY\LocalService 0
WinHTTP Web Proxy Auto-Discovery Service WinHttpAutoProxySvc
Stopped Manual Share Process
c:\windows\system32\svchost.exe -k localservice Normal NT
AUTHORITY\LocalService 0
Windows Management Instrumentation winmgmt Running Auto Share
Process c:\windows\system32\svchost.exe -k netsvcs Ignore
LocalSystem 0
Portable Media Serial Number WmdmPmSp Stopped Manual Share
Process c:\windows\system32\svchost.exe -k netsvcs Normal
LocalSystem 0
Windows Management Instrumentation Driver Extensions Wmi Stopped
Manual Share Process c:\windows\system32\svchost.exe -k
netsvcs Normal LocalSystem 0
WMI Performance Adapter WmiApSrv Stopped Manual Own Process
c:\windows\system32\wbem\wmiapsrv.exe Normal LocalSystem
0
Automatic Updates wuauerv Stopped Manual Share Process
c:\windows\system32\svchost.exe -k netsvcs Normal
LocalSystem 0
Wireless Configuration WZCSVC Stopped Manual Share
Process c:\windows\system32\svchost.exe -k netsvcs Normal
LocalSystem 0

```

Appendix C – Tunable Parameters

[Program Groups]

Group Name	Name	User Name	
Accessories	Default User:Accessories	Default User	
Accessories\Accessibility	Default User:Accessories\Accessibility	Default User	
Accessories\Entertainment	Default User:Accessories\Entertainment	Default User	
Startup	Default User:Startup	Default User	
Accessories	All Users:Accessories	All Users	
Accessories\Accessibility	All Users:Accessories\Accessibility	All Users	
Accessories\Communications	All Users:Accessories\Communications	All Users	
Accessories\Entertainment	All Users:Accessories\Entertainment	All Users	
Accessories\System Tools	All Users:Accessories\System Tools	All Users	
Administrative Tools	All Users:Administrative Tools	All Users	
Microsoft SQL Server	All Users:Microsoft SQL Server	All Users	
Startup	All Users:Startup	All Users	
WinZip	All Users:WinZip	All Users	
Accessories	NT AUTHORITY\SYSTEM:Accessories	NT AUTHORITY\SYSTEM	
Accessories\Accessibility	NT AUTHORITY\SYSTEM:Accessories\Accessibility	NT AUTHORITY\SYSTEM	
Accessories\Entertainment	NT AUTHORITY\SYSTEM:Accessories\Entertainment	NT AUTHORITY\SYSTEM	
Startup	NT AUTHORITY\SYSTEM:Startup	NT AUTHORITY\SYSTEM	
Accessories	PE6500\Administrator:Accessories	PE6500\Administrator	
Accessories\Accessibility	PE6500\Administrator:Accessories\Accessibility	PE6500\Administrator	
Accessories\Entertainment	PE6500\Administrator:Accessories\Entertainment	PE6500\Administrator	
Administrative Tools	PE6500\Administrator:Administrative Tools	PE6500\Administrator	
Startup	PE6500\Administrator:Startup	PE6500\Administrator	

[Startup Programs]

Program	Command	User Name	Location
desktop	desktop.ini	NT AUTHORITY\SYSTEM	Startup
desktop	desktop.ini	PE6500\Administrator	Startup
desktop	desktop.ini	.DEFAULT	Startup
desktop	desktop.ini	All Users	Common Startup
KernelFaultCheck	%systemroot%\system32\dumprep 0 -k	All Users	HKLM\SOFTWARE\Microsoft\Windows\CurrentVersion\Run

[OLE Registration]

Object	Local Server
Sound (OLE2)	sndrec32.exe
Media Clip	mplay32.exe

Appendix C – Tunable Parameters

Video Clip mplay32.exe /avi
MIDI Sequence mplay32.exe /mid
Sound Not Available
Media Clip Not Available
Windows Media Player 7 Not Available
WordPad Document "%programfiles%\windows nt\accessories\wordpad.exe"
Windows Media Services DRM Storage object Not Available
Bitmap Image mspaint.exe

[Windows Error Reporting]

Time Type Details
System Information report written at: 12/19/02 11:30:39
System Name: PE6500
[Internet Settings]

[Internet Explorer]

[Following are sub-categories of this main category]
[Summary]

Item Value
Version 6.0.3663.0
Build 63663
Application Path C:\Program Files\Internet Explorer
Language English (United States)
Active Printer Not Available

Cipher Strength 128-bit
Content Advisor Disabled
IEAK Install No

[File Versions]

File	Version	Size	Date	Path	Company
actxprxy.dll	6.0.3663.0	95 KB	7/29/2002 12:08:47 PM	C:\WINDOWS\system32	Microsoft Corporation
actxprxy.dll	6.0.3663.0	95 KB	7/29/2002 12:08:47 PM		Microsoft Corporation
advpack.dll	6.0.3663.0	93 KB	7/29/2002 12:09:03 PM	C:\WINDOWS\system32	Microsoft Corporation
advpack.dll	6.0.3663.0	93 KB	7/29/2002 12:09:03 PM		Microsoft Corporation
asctrls.ocx	6.0.3663.0	89 KB	7/29/2002 12:09:36 PM	C:\WINDOWS\system32	Microsoft Corporation
asctrls.ocx	6.0.3663.0	89 KB	7/29/2002 12:09:36 PM		Microsoft Corporation
browseic.dll	6.0.3663.0	62 KB	7/29/2002 12:10:34 PM	C:\WINDOWS\system32	Microsoft Corporation
browseic.dll	6.0.3663.0	62 KB	7/29/2002 12:10:34 PM		Microsoft Corporation
browseui.dll	6.0.3663.0	1,000 KB	7/29/2002 12:10:35 PM	C:\WINDOWS\system32	Microsoft Corporation

Appendix C – Tunable Parameters

```
browseui.dll      6.0.3663.0  1,000 KB    7/29/2002 12:10:35 PM  .
  Microsoft Corporation
cdfview.dll 6.0.3663.0  141 KB      7/29/2002 12:10:50 PM
  C:\WINDOWS\system32 Microsoft Corporation
cdfview.dll 6.0.3663.0  141 KB      7/29/2002 12:10:50 PM  .
  Microsoft Corporation
comctl32.dll    5.82.3663.0 560 KB      7/29/2002 12:11:51 PM
  C:\WINDOWS\system32 Microsoft Corporation
comctl32.dll    5.82.3663.0 560 KB      7/29/2002 12:11:51 PM  .
  Microsoft Corporation
dxtrans.dll 6.3.3663.0  188 KB      7/29/2002 12:17:50 PM
  C:\WINDOWS\system32 Microsoft Corporation
dxtrans.dll 6.3.3663.0  188 KB      7/29/2002 12:17:50 PM  .
  Microsoft Corporation
dxtmsft.dll 6.3.3663.0  332 KB      7/29/2002 12:17:49 PM
  C:\WINDOWS\system32 Microsoft Corporation
dxtmsft.dll 6.3.3663.0  332 KB      7/29/2002 12:17:49 PM  .
  Microsoft Corporation
iecont.dll <File Missing> Not Available Not Available Not
Available Not Available
iecontlc.dll <File Missing> Not Available Not Available
  Not Available Not Available
iedkcs32.dll 16.0.3663.0 292 KB      7/29/2002 12:22:03 PM
  C:\WINDOWS\system32 Microsoft Corporation
iedkcs32.dll 16.0.3663.0 292 KB      7/29/2002 12:22:03 PM  .
  Microsoft Corporation
iepeers.dll 6.0.3663.0  229 KB      7/29/2002 12:22:08 PM
  C:\WINDOWS\system32 Microsoft Corporation
iepeers.dll 6.0.3663.0  229 KB      7/29/2002 12:22:08 PM  .
  Microsoft Corporation
iesetup.dll 6.0.3663.0  59 KB      7/29/2002 12:22:09 PM
  C:\WINDOWS\system32 Microsoft Corporation
iesetup.dll 6.0.3663.0  59 KB      7/29/2002 12:22:09 PM  . Microsoft
Corporation
ieuinit.inf Not Available 19 KB 7/29/2002 12:22:11 PM
  C:\WINDOWS\system32 Not Available
ieuinit.inf Not Available 19 KB 7/29/2002 12:22:11 PM  . Not
Available
iexplore.exe 6.0.3663.0  90 KB 7/29/2002 12:22:12 PM C:\Program
Files\Internet Explorer Microsoft Corporation
imgutil.dll 6.0.3663.0  30 KB 7/29/2002 12:22:31 PM
  C:\WINDOWS\system32 Microsoft Corporation
imgutil.dll 6.0.3663.0  30 KB 7/29/2002 12:22:31 PM  . Microsoft
Corporation
inetcpl.cpl 6.0.3663.0 296 KB      7/29/2002 12:22:35 PM
  C:\WINDOWS\system32 Microsoft Corporation
inetcpl.cpl 6.0.3663.0 296 KB      7/29/2002 12:22:35 PM  .
  Microsoft Corporation
inetcplc.dll 6.0.3663.0 108 KB      7/29/2002 12:22:35 PM
  C:\WINDOWS\system32 Microsoft Corporation
inetcplc.dll 6.0.3663.0 108 KB      7/29/2002 12:22:35 PM  .
  Microsoft Corporation
inseng.dll 6.0.3663.0 71 KB 7/29/2002 12:22:48 PM
  C:\WINDOWS\system32 Microsoft Corporation
```

Appendix C – Tunable Parameters

inseng.dll	6.0.3663.0	71 KB	7/29/2002 12:22:48 PM	.	Microsoft Corporation
mlang.dll	6.0.3663.0	565 KB	7/29/2002 12:29:34 PM		C:\WINDOWS\system32 Microsoft Corporation
mlang.dll	6.0.3663.0	565 KB	7/29/2002 12:29:34 PM	.	Microsoft Corporation
msencode.dll	2000.7.25.0	92 KB	7/29/2002 12:31:53 PM		C:\WINDOWS\system32 Not Available
msencode.dll	2000.7.25.0	92 KB	7/29/2002 12:31:53 PM	.	Not Available
mshta.exe	6.0.3663.0	27 KB	7/29/2002 12:32:11 PM		C:\WINDOWS\system32 Microsoft Corporation
mshta.exe	6.0.3663.0	27 KB	7/29/2002 12:32:11 PM	.	Microsoft Corporation
mshtml.dll	6.0.3663.0	2,628 KB	7/29/2002 12:32:12 PM		C:\WINDOWS\system32 Microsoft Corporation
mshtml.dll	6.0.3663.0	2,628 KB	7/29/2002 12:32:12 PM	.	Microsoft Corporation
mshtml.tlb	6.0.3663.0	1,319 KB	7/29/2002 12:32:13 PM		C:\WINDOWS\system32 Microsoft Corporation
mshtml.tlb	6.0.3663.0	1,319 KB	7/29/2002 12:32:13 PM	.	Microsoft Corporation
mshtml.ed.dll	6.0.3663.0	424 KB	7/29/2002 12:32:13 PM		C:\WINDOWS\system32 Microsoft Corporation
mshtml.ed.dll	6.0.3663.0	424 KB	7/29/2002 12:32:13 PM	.	Microsoft Corporation
mshtmler.dll	6.0.3663.0	55 KB	7/29/2002 12:32:14 PM		C:\WINDOWS\system32 Microsoft Corporation
mshtmler.dll	6.0.3663.0	55 KB	7/29/2002 12:32:14 PM	.	Microsoft Corporation
msident.dll	6.0.3663.0	47 KB	7/29/2002 12:32:16 PM		C:\WINDOWS\system32 Microsoft Corporation
msident.dll	6.0.3663.0	47 KB	7/29/2002 12:32:16 PM	.	Microsoft Corporation
msidntld.dll	6.0.3663.0	15 KB	7/29/2002 12:32:17 PM		C:\WINDOWS\system32 Microsoft Corporation
msidntld.dll	6.0.3663.0	15 KB	7/29/2002 12:32:17 PM	.	Microsoft Corporation
msieftp.dll	6.0.3663.0	232 KB	7/29/2002 12:32:17 PM		C:\WINDOWS\system32 Microsoft Corporation
msieftp.dll	6.0.3663.0	232 KB	7/29/2002 12:32:17 PM	.	Microsoft Corporation
msrating.dll	6.0.3663.0	132 KB	7/29/2002 12:33:02 PM		C:\WINDOWS\system32 Microsoft Corporation
msrating.dll	6.0.3663.0	132 KB	7/29/2002 12:33:02 PM	.	Microsoft Corporation
mstime.dll	6.0.3663.0	490 KB	7/29/2002 12:33:14 PM		C:\WINDOWS\system32 Microsoft Corporation
mstime.dll	6.0.3663.0	490 KB	7/29/2002 12:33:14 PM	.	Microsoft Corporation
occache.dll	6.0.3663.0	88 KB	7/29/2002 12:36:56 PM		C:\WINDOWS\system32 Microsoft Corporation
occache.dll	6.0.3663.0	88 KB	7/29/2002 12:36:56 PM	.	Microsoft Corporation

Appendix C – Tunable Parameters

proctexe.ocx	6.3.3663.0	78 KB	7/29/2002 12:50:00 PM		
C:\WINDOWS\system32		Intel Corporation			
proctexe.ocx	6.3.3663.0	78 KB	7/29/2002 12:50:00 PM	.	Intel Corporation
sendmail.dll	6.0.3663.0	54 KB	7/29/2002 12:55:07 PM		
C:\WINDOWS\system32		Microsoft Corporation			
sendmail.dll	6.0.3663.0	54 KB	7/29/2002 12:55:07 PM	.	
Microsoft Corporation					
shdoclc.dll	6.0.3663.0	521 KB	7/29/2002 12:55:57 PM		
C:\WINDOWS\system32		Microsoft Corporation			
shdoclc.dll	6.0.3663.0	521 KB	7/29/2002 12:55:57 PM	.	
Microsoft Corporation					
shdocvw.dll	6.0.3663.0	1,311 KB	7/29/2002 12:55:57 PM		
C:\WINDOWS\system32		Microsoft Corporation			
shdocvw.dll	6.0.3663.0	1,311 KB	7/29/2002 12:55:57 PM	.	
Microsoft Corporation					
shfolder.dll	6.0.3663.0	23 KB	7/29/2002 12:56:01 PM		
C:\WINDOWS\system32		Microsoft Corporation			
shfolder.dll	6.0.3663.0	23 KB	7/29/2002 12:56:01 PM	.	
Microsoft Corporation					
shlwapi.dll	6.0.3663.0	269 KB	7/29/2002 12:56:04 PM		
C:\WINDOWS\system32		Microsoft Corporation			
shlwapi.dll	6.0.3663.0	269 KB	7/29/2002 12:56:04 PM	.	
Microsoft Corporation					
tdc.ocx	1.3.0.3130	57 KB	7/29/2002 12:59:22 PM		
C:\WINDOWS\system32		Microsoft Corporation			
tdc.ocx	1.3.0.3130	57 KB	7/29/2002 12:59:22 PM	.	Microsoft Corporation
url.dll	6.0.3663.0	40 KB	7/29/2002 1:01:36 PM		
C:\WINDOWS\system32		Microsoft Corporation			
url.dll	6.0.3663.0	40 KB	7/29/2002 1:01:36 PM	.	Microsoft Corporation
urlmon.dll	6.0.3663.0	442 KB	7/29/2002 1:01:37 PM		
C:\WINDOWS\system32		Microsoft Corporation			
urlmon.dll	6.0.3663.0	442 KB	7/29/2002 1:01:37 PM	.	
Microsoft Corporation					
webcheck.dll	6.0.3663.0	254 KB	7/29/2002 1:04:06 PM		
C:\WINDOWS\system32		Microsoft Corporation			
webcheck.dll	6.0.3663.0	254 KB	7/29/2002 1:04:06 PM	.	
Microsoft Corporation					
wininet.dll	6.0.3663.0	581 KB	7/29/2002 1:04:46 PM		
C:\WINDOWS\system32		Microsoft Corporation			
wininet.dll	6.0.3663.0	581 KB	7/29/2002 1:04:46 PM	.	
Microsoft Corporation					

[Connectivity]

Item Value

Connection Preference Never dial

LAN Settings

AutoConfigProxy Not Available

AutoProxyDetectMode Disabled

AutoConfigURL

Appendix C – Tunable Parameters

Proxy Disabled
ProxyServer
ProxyOverride

[Cache]

[Following are sub-categories of this main category]
[Summary]

Item	Value
Page Refresh Type	Automatic
Temporary Internet Files Folder	C:\Documents and Settings\NetworkService\Local Settings\Temporary Internet Files
Total Disk Space	Not Available
Available Disk Space	Not Available
Maximum Cache Size	Not Available
Available Cache Size	Not Available

[List of Objects]

Program File	Status	CodeBase
No cached object information available		

[Content]

[Following are sub-categories of this main category]
[Summary]

Item	Value
Content Advisor	Disabled

[Personal Certificates]

Issued To	Issued By	Validity	Signature Algorithm
No personal certificate information available			

[Other People Certificates]

Issued To	Issued By	Validity	Signature Algorithm
No other people certificate information available			

[Publishers]

Name
No publisher information available

[Security]

Zone	Security Level
My Computer	Custom
Local intranet	Medium-low
Trusted sites	Low
Internet	Medium
Restricted sites	High

Appendix C – Tunable Parameters

Client Configuration Parameters

COM+ Settings

TPCC.AllTxns:

Activation:

- Enable Object Pooling selected
- Minimum Pool Size: 80
- Maximum Pool Size: 80
- Creation Timeout: 60,000
- Enable Object Construction
- Enable Just in Time Activation

Concurrency:

- Concurrency Required

TPCC Application Registry Parameters

Windows Registry Editor Version 5.00

```
[HKEY_LOCAL_MACHINE\SOFTWARE\Microsoft\TPCC]
"Path"="c:\\inetpub\\wwwroot\\"
"NumberOfDeliveryThreads"=dword:00000013
"MaxConnections"=dword:00002ee0
"MaxPendingDeliveries"=dword:000005dc
"DB_Protocol"="DBLIB"
"TxnMonitor"="COM"
"DbServer"="pe6500"
"DbName"="tpcc"
"DbUser"="sa"
"DbPassword"=""
"COM_SinglePool"="YES"
```

Microsoft Internet Information Server Registry Parameters

```
[HKEY_LOCAL_MACHINE\SYSTEM\CurrentControlSet\Services\InetInfo]
```

```
[HKEY_LOCAL_MACHINE\SYSTEM\CurrentControlSet\Services\InetInfo\Parameters]
```

```
"ListenBackLog"=dword:00000019
"DispatchEntries"=hex(7):4c,00,44,00,41,00,50,00,53,00,56,00,43,00,00,00,00,00
"PoolThreadLimit"=dword:000000be
"ThreadTimeout"=dword:00015180
```

```
[HKEY_LOCAL_MACHINE\SYSTEM\CurrentControlSet\Services\InetInfo\Performance]
```

```
"Library"="infcstrs.dll"
"Open"="OpenINFOPerformanceData"
"Close"="CloseINFOPerformanceData"
"Collect"="CollectINFOPerformanceData"
"Last Counter"=dword:00000842
"Last Help"=dword:00000843
"First Counter"=dword:00000802
"First Help"=dword:00000803
"Library Validation Code"=hex:de,fc,ed,18,0a,98,c0,01,10,25,00,00,00,00,00,00
"WbemAdapFileTime"=hex:00,60,4e,96,aa,40,bf,01
"WbemAdapFileSize"=dword:00002510
"WbemAdapStatus"=dword:00000000
```

World Wide Web Service Registry Parameters

Appendix C – Tunable Parameters

Windows Registry Editor Version 5.00

```
[HKEY_LOCAL_MACHINE\SYSTEM\CurrentControlSet\Services\W3SVC]
"Type"=dword:00000020
"Start"=dword:00000002
"ErrorControl"=dword:00000001
"ImagePath"=hex(2):43,00,3a,00,5c,00,57,00,49,00,4e,00,4e,00,54,00,5c,00,53,00,\
  79,00,73,00,74,00,65,00,6d,00,33,00,32,00,5c,00,69,00,6e,00,65,00,74,00,73,\
  00,72,00,76,00,5c,00,69,00,6e,00,65,00,74,00,69,00,6e,00,66,00,6f,00,2e,00,\
  65,00,78,00,65,00,00,00
"DisplayName"="World Wide Web Publishing Service"
"DependOnService"=hex(7):49,00,49,00,53,00,41,00,44,00,4d,00,49,00,4e,00,00,00,\
  00,00
"DependOnGroup"=hex(7):00,00
"ObjectName"="LocalSystem"
"Description"="Provides Web connectivity and administration through the Internet Information
Services snap-in."
```

```
[HKEY_LOCAL_MACHINE\SYSTEM\CurrentControlSet\Services\W3SVC\ASP]
"NOTE"="This is for backward compatibility only."
```

```
[HKEY_LOCAL_MACHINE\SYSTEM\CurrentControlSet\Services\W3SVC\ASP\Parameters]
```

```
[HKEY_LOCAL_MACHINE\SYSTEM\CurrentControlSet\Services\W3SVC\Parameters]
"MajorVersion"=dword:00000005
"MinorVersion"=dword:00000000
"InstallPath"="C:\\WINNT\\System32\\inetsrv"
"CertMapList"="C:\\WINNT\\System32\\inetsrv\\iisrmap.dll"
"AccessDeniedMessage"="Error: Access is Denied."
"Filter DLLs"=""
"LogFileDirectory"="C:\\WINNT\\System32\\LogFiles"
"AcceptExOutstanding"=dword:00000028
```

```
[HKEY_LOCAL_MACHINE\SYSTEM\CurrentControlSet\Services\W3SVC\Parameters\ADCLaunch]
ch]
```

```
[HKEY_LOCAL_MACHINE\SYSTEM\CurrentControlSet\Services\W3SVC\Parameters\ADCLaunch\AdvancedDataFactory]
```

```
[HKEY_LOCAL_MACHINE\SYSTEM\CurrentControlSet\Services\W3SVC\Parameters\ADCLaunch\RDSServer.DataFactory]
```

```
[HKEY_LOCAL_MACHINE\SYSTEM\CurrentControlSet\Services\W3SVC\Parameters\Script
Map]
```

```
[HKEY_LOCAL_MACHINE\SYSTEM\CurrentControlSet\Services\W3SVC\Parameters\Virtual
Roots]
```

```
"/"="c:\\inetpub\\wwwroot,,205"
"/Scripts"="c:\\inetpub\\scripts,,204"
"/IISHelp"="c:\\winnt\\help\\iishelp,,201"
"/IISAdmin"="C:\\WINNT\\System32\\inetsrv\\iisadmin,,201"
"/IISamples"="c:\\inetpub\\iissamples,,201"
"/MSADC"="c:\\program files\\common files\\system\\msadc,,205"
"/_vti_bin"="C:\\Program Files\\Common Files\\Microsoft Shared\\Web Server
Extensions\\40\\isapi,,205"
```

Appendix C – Tunable Parameters

"/Rpc"="C:\\WINNT\\System32\\RpcProxy,,4"
"/Printers"="C:\\WINNT\\web\\printers,,201"

[HKEY_LOCAL_MACHINE\\SYSTEM\\CurrentControlSet\\Services\\W3SVC\\Performance]

"Library"="w3ctrs.dll"
"Open"="OpenW3PerformanceData"
"Close"="CloseW3PerformanceData"
"Collect"="CollectW3PerformanceData"
"Last Counter"=dword:000008e6
"Last Help"=dword:000008e7
"First Counter"=dword:00000844
"First Help"=dword:00000845
"Library Validation Code"=hex:86,2b,a6,1b,0a,98,c0,01,10,3d,00,00,00,00,00,00
"WbemAdapFileTime"=hex:00,60,4e,96,aa,40,bf,01
"WbemAdapFileSize"=dword:00003d10
"WbemAdapStatus"=dword:00000000

[HKEY_LOCAL_MACHINE\\SYSTEM\\CurrentControlSet\\Services\\W3SVC\\Security]

"Security"=hex:01,00,14,80,a0,00,00,00,ac,00,00,00,14,00,00,00,30,00,00,00,02,\\
00,1c,00,01,00,00,00,02,80,14,00,ff,01,0f,00,01,01,00,00,00,00,00,01,00,00,\\
00,00,02,00,70,00,04,00,00,00,00,18,00,fd,01,02,00,01,01,00,00,00,00,00,\\
05,12,00,00,00,74,00,6f,00,00,00,1c,00,ff,01,0f,00,01,02,00,00,00,00,00,05,\\
20,00,00,00,20,02,00,00,72,00,73,00,00,00,18,00,8d,01,02,00,01,01,00,00,00,\\
00,00,05,0b,00,00,00,20,02,00,00,00,00,1c,00,fd,01,02,00,01,02,00,00,00,00,\\
00,05,20,00,00,00,23,02,00,00,72,00,73,00,01,01,00,00,00,00,00,05,12,00,00,\\
00,01,01,00,00,00,00,00,05,12,00,00,00

[HKEY_LOCAL_MACHINE\\SYSTEM\\CurrentControlSet\\Services\\W3SVC\\Enum]

"0"="Root\\LEGACY_W3SVC\\0000"
"Count"=dword:00000001
"NextInstance"=dword:00000001

Microsoft Windows 2000 Server System Information Report for PE1500

System Information report written at: 12/21/2002 03:05:07 PM
[System Information]

[Following are sub-categories of this main category]

[System Summary]

Item	Value
OS Name	Microsoft Windows 2000 Server
Version	5.0.2195 Service Pack 1 Build 2195
OS Manufacturer	Microsoft Corporation
System Name	CLIENT1
System Manufacturer	Dell Computer Corporation
System Model	PowerEdge 1500SC
System Type	X86-based PC
Processor	x86 Family 6 Model 11 Stepping 1 GenuineIntel ~1130 Mhz
BIOS Version	Phoenix ROM BIOS PLUS Version 1.10 A02
Windows Directory	C:\\WINNT
System Directory	C:\\WINNT\\System32

Appendix C – Tunable Parameters

Boot Device \Device\Harddisk0\Partition1
Locale United States
User Name CLIENT1\Administrator
Time Zone Central Standard Time
Total Physical Memory 523,764 KB
Available Physical Memory 339,064 KB
Total Virtual Memory 1,802,064 KB
Available Virtual Memory 1,454,844 KB
Page File Space 1,278,300 KB
Page File C:\pagefile.sys

[Hardware Resources]

[Following are sub-categories of this main category]

[Conflicts/Sharing]

Resource	Device
IRQ 11	Standard OpenHCD USB Host Controller
IRQ 11	PCI standard host CPU bridge

[DMA]

Channel	Device	Status
4	Direct memory access controller	OK
2	Standard floppy disk controller	OK

[Forced Hardware]

Device	PNP Device ID
No Forced Hardware	

[I/O]

Address Range	Device	Status
0x0000-0x03AF	PCI bus	OK
0x0000-0x03AF	Direct memory access controller	OK
0x03B0-0x03DF	PCI bus	OK
0x03B0-0x03DF	ATI Technologies Inc. RAGE XL PCI	OK
0x03E0-0x0FFF	PCI bus	OK
0xE000-0xEFFF	PCI bus	OK
0xECC0-0xECFE	Intel(R) PRO/100 S Server Adapter	OK
0xEC80-0xECBF	Intel(R) PRO/100 S Server Adapter #2	OK
0xE800-0xE8FF	ATI Technologies Inc. RAGE XL PCI	OK
0x03C0-0x03DF	ATI Technologies Inc. RAGE XL PCI	OK
0x0A79-0x0A79	ISAPNP Read Data Port	OK
0x0279-0x0279	ISAPNP Read Data Port	OK
0x02F4-0x02F7	ISAPNP Read Data Port	OK
0x0080-0x009F	Direct memory access controller	OK
0x00C0-0x00DF	Direct memory access controller	OK
0x00F0-0x00FF	Numeric data processor	OK
0x0020-0x003F	Programmable interrupt controller	OK
0x00A0-0x00BF	Programmable interrupt controller	OK
0x04D0-0x04D1	Programmable interrupt controller	OK
0x0061-0x0061	System speaker	OK

Appendix C – Tunable Parameters

0x0040-0x005F	System timer	OK
0x03F0-0x03F5	Standard floppy disk controller	OK
0x03F7-0x03F7	Standard floppy disk controller	OK
0x0060-0x0060	Standard 101/102-Key or Microsoft Natural PS/2 Keyboard	OK
0x0064-0x0064	Standard 101/102-Key or Microsoft Natural PS/2 Keyboard	OK
0x03F8-0x03FF	Communications Port (COM1)	OK
0x0378-0x037F	ECP Printer Port (LPT1)	OK
0x0778-0x077F	ECP Printer Port (LPT1)	OK
0x0070-0x007F	System CMOS/real time clock	OK
0x0814-0x085B	System board	OK
0x0820-0x083F	System board	OK
0x0580-0x058F	System board	OK
0x0C00-0x0CD7	System board	OK
0x0F50-0x0F58	System board	OK
0x00E0-0x00EF	System board	OK
0x08B0-0x08BF	Standard Dual Channel PCI IDE Controller	OK
0x08C0-0x08C3	Standard Dual Channel PCI IDE Controller	OK
0x01F0-0x01F7	Primary IDE Channel	OK
0x03F6-0x03F6	Primary IDE Channel	OK
0x0170-0x0177	Secondary IDE Channel	OK
0x0376-0x0376	Secondary IDE Channel	OK
0xD000-0xDFFF	PCI bus	OK
0xDC00-0xDCFF	Adaptec AIC-7899 Ultra160/m PCI SCSI Card	OK
0xD800-0xD8FF	Adaptec AIC-7899 Ultra160/m PCI SCSI Card	OK
0xC000-0xCFFF	PCI bus	OK

[IRQs]

IRQ Number Device

9	Microsoft ACPI-Compliant System
17	Intel(R) PRO/100 S Server Adapter
20	Intel(R) PRO/100 S Server Adapter #2
13	Numeric data processor
6	Standard floppy disk controller
1	Standard 101/102-Key or Microsoft Natural PS/2 Keyboard
12	PS/2 Compatible Mouse
4	Communications Port (COM1)
8	System CMOS/real time clock
14	Primary IDE Channel
11	Standard OpenHCD USB Host Controller
11	PCI standard host CPU bridge
29	Adaptec AIC-7899 Ultra160/m PCI SCSI Card
30	Adaptec AIC-7899 Ultra160/m PCI SCSI Card

[Memory]

Range	Device	Status
0xA0000-0xBFFFF	PCI bus	OK
0xA0000-0xBFFFF	ATI Technologies Inc. RAGE XL PCI	OK
0xD0000-0xE7FFF	PCI bus	OK
0xFD000000-0xFE1FFFFFF	PCI bus	OK
0xFD000000-0xFE1FFFFFF	ATI Technologies Inc. RAGE XL PCI	OK
0xFE143000-0xFE143FFF	Intel(R) PRO/100 S Server Adapter	OK

Appendix C – Tunable Parameters

```

0xFE120000-0xFE13FFFF Intel(R) PRO/100 S Server Adapter OK
0xFE142000-0xFE142FFF Intel(R) PRO/100 S Server Adapter #2 OK
0xFE100000-0xFE11FFFF Intel(R) PRO/100 S Server Adapter #2 OK
0xFE141000-0xFE141FFF ATI Technologies Inc. RAGE XL PCI OK
0xFE140000-0xFE140FFF Standard OpenHCD USB Host Controller OK
0xFE000000-0xFEBFFFFF PCI bus OK
0xFEB01000-0xFEB01FFF Adaptec AIC-7899 Ultra160/m PCI SCSI Card OK
0xFEB00000-0xFEB00FFF Adaptec AIC-7899 Ultra160/m PCI SCSI Card OK
0xFE800000-0xFE9FFFFF PCI bus OK
0x0000-0x9FFFF System board OK
0x100000-0x1FFFFFFF System board OK
0xF0000-0xFFFFF System board OK
0xFEC00000-0xFEC0FFFF System board OK
0xFEE00000-0xFEE0FFFF System board OK
0xFFE00000-0xFFFFFFF System board OK

```

[Components]

[Following are sub-categories of this main category]

[Multimedia]

[Following are sub-categories of this main category]

[Audio Codecs]

Codec	Manufacturer	Description	Status	File	Version	Size
c:\winnt\system32\iac25_32.ax	Intel Corporation	Indeo® audio software	OK	C:\WINNT\System32\IAC25_32.AX	2.05.53	195.00 KB (199,680 bytes)
c:\winnt\system32\msg723.acm	Microsoft Corporation		OK	C:\WINNT\System32\MSG723.ACM	4.4.3385	106.77 KB (109,328 bytes)
c:\winnt\system32\lhacm.acm	Microsoft Corporation		OK	C:\WINNT\System32\LHACM.ACM	4.4.3385	33.27 KB (34,064 bytes)
c:\winnt\system32\tssoft32.acm	DSP GROUP, INC.		OK	C:\WINNT\System32\TSSOFT32.ACM	1.01	9.27 KB (9,488 bytes)
c:\winnt\system32\msgsm32.acm	Microsoft Corporation		OK	C:\WINNT\System32\MSGSM32.ACM	5.00.2134.1	22.27 KB (22,800 bytes)
c:\winnt\system32\msg711.acm	Microsoft Corporation		OK	C:\WINNT\System32\MSG711.ACM	5.00.2134.1	10.27 KB (10,512 bytes)
c:\winnt\system32\msadp32.acm	Microsoft Corporation		OK	C:\WINNT\System32\MSADP32.ACM	5.00.2134.1	14.77 KB (15,120 bytes)
c:\winnt\system32\imaadp32.acm	Microsoft Corporation		OK	C:\WINNT\System32\IMAADP32.ACM	5.00.2134.1	16.27 KB (16,656 bytes)

[Video Codecs]

Appendix C – Tunable Parameters

Codec	Manufacturer	Description	Status	File	Version	Size
c:\winnt\system32\ir50_32.dll	Intel Corporation	Indeo® video	5.10 OK			
	C:\WINNT\System32\IR50_32.DLL	R.5.10.15.2.55			737.50 KB	
(755,200 bytes)		7/26/2000 7:00:00 AM				
c:\winnt\system32\msh261.drv	Microsoft Corporation		OK			
	C:\WINNT\System32\MSH261.DRV	4.4.3385			163.77 KB (167,696 bytes)	
		3/29/2002 12:38:55 PM				
c:\winnt\system32\msh263.drv	Microsoft Corporation		OK			
	C:\WINNT\System32\MSH263.DRV	4.4.3385			252.27 KB (258,320 bytes)	
		3/29/2002 12:38:34 PM				
c:\winnt\system32\msvidc32.dll	Microsoft Corporation		OK			
	C:\WINNT\System32\MSVIDC32.DLL	5.00.2134.1			27.27 KB (27,920 bytes)	
		7/26/2000 7:00:00 AM				
c:\winnt\system32\msrle32.dll	Microsoft Corporation		OK			
	C:\WINNT\System32\MSRLE32.DLL	5.00.2134.1			10.77 KB (11,024 bytes)	
		7/26/2000 7:00:00 AM				
c:\winnt\system32\ir32_32.dll	Intel(R) Corporation		OK			
	C:\WINNT\System32\IR32_32.DLL	Not Available			194.50 KB	
(199,168 bytes)		7/26/2000 7:00:00 AM				
c:\winnt\system32\iccvid.dll	Radius Inc.		OK			
	C:\WINNT\System32\ICCVID.DLL	1.10.0.6			108.00 KB (110,592 bytes)	
		7/26/2000 7:00:00 AM				

[CD-ROM]

Item Value

Drive D:

Description CD-ROM Drive

Media Loaded True

Media Type CD-ROM

Name LG CD-ROM CRD-8482B

Manufacturer (Standard CD-ROM drives)

Status OK

Transfer Rate Not Available

SCSI Target ID 0

PNP Device ID IDE\CDROMLG_CD-ROM_CRD-

8482B_____1.05____\5&129881D0&0&0.0.0

[Sound Device]

Item Value

No sound devices

[Display]

Item Value

Name ATI Technologies Inc. RAGE XL PCI

PNP Device ID

PCI\VEN_1002&DEV_4752&SUBSYS_011C1028&REV_27\3&13C0B0C5&0&70

Adapter Type ATI RAGE XL PCI, ATI Technologies Inc. compatible

Adapter Description ATI Technologies Inc. RAGE XL PCI

Adapter RAM 4.00 MB (4,194,304 bytes)

Installed Drivers atidrab.dll

Appendix C – Tunable Parameters

Driver Version 5.00.2179.1
INF File display.inf (atirage3 section)
Color Planes 1
Color Table Entries 256
Resolution 1024 x 768 x 60 hertz
Bits/Pixel 8

[Infrared]

Item Value
No infrared devices

[Input]

[Following are sub-categories of this main category]

[Keyboard]

Item Value
Description Standard 101/102-Key or Microsoft Natural PS/2 Keyboard
Name Enhanced (101- or 102-key)
Layout 00000409
PNP Device ID ACPI\PNP0303\4&639D4DC&0
NumberOfFunctionKeys 12

[Pointing Device]

Item Value
Hardware Type PS/2 Compatible Mouse
Number of Buttons 3
Status OK
PNP Device ID ACPI\PNP0F13\4&639D4DC&0
Power Management Supported False
Double Click Threshold 6
Handedness Right Handed Operation

[Modem]

Item Value
No modems

[Network]

[Following are sub-categories of this main category]

[Adapter]

Item Value
Name [00000000] RAS Async Adapter
Adapter Type Not Available
Product Name RAS Async Adapter
Installed True

Appendix C – Tunable Parameters

PNP Device ID Not Available
Last Reset 10/25/2002 4:01:29 AM
Index 0
Service Name AsyncMac
IP Address Not Available
IP Subnet Not Available
Default IP Gateway Not Available
DHCP Enabled False
DHCP Server Not Available
DHCP Lease Expires Not Available
DHCP Lease Obtained Not Available
MAC Address Not Available
Service Name Not Available

Name [00000001] WAN Miniport (L2TP)
Adapter Type Not Available
Product Name WAN Miniport (L2TP)
Installed True
PNP Device ID ROOT\MS_L2TPMINIPORT\0000
Last Reset 10/25/2002 4:01:29 AM
Index 1
Service Name Rasl2tp
IP Address Not Available
IP Subnet Not Available
Default IP Gateway Not Available
DHCP Enabled False
DHCP Server Not Available
DHCP Lease Expires Not Available
DHCP Lease Obtained Not Available
MAC Address Not Available
Service Name Rasl2tp
Driver c:\winnt\system32\drivers\rasl2tp.sys (50800, 5.00.2179.1)

Name [00000002] WAN Miniport (PPTP)
Adapter Type Wide Area Network (WAN)
Product Name WAN Miniport (PPTP)
Installed True
PNP Device ID ROOT\MS_PPTPMINIPORT\0000
Last Reset 10/25/2002 4:01:29 AM
Index 2
Service Name PptpMiniport
IP Address Not Available
IP Subnet Not Available
Default IP Gateway Not Available
DHCP Enabled False
DHCP Server Not Available
DHCP Lease Expires Not Available
DHCP Lease Obtained Not Available
MAC Address 50:50:54:50:30:30
Service Name PptpMiniport
Driver c:\winnt\system32\drivers\raspptp.sys (47856, 5.00.2160.1)

Name [00000003] Direct Parallel
Adapter Type Not Available
Product Name Direct Parallel

Appendix C – Tunable Parameters

Installed True
PNP Device ID ROOT\MS_PTMINIPOINT\0000
Last Reset 10/25/2002 4:01:29 AM
Index 3
Service Name Raspti
IP Address Not Available
IP Subnet Not Available
Default IP Gateway Not Available
DHCP Enabled False
DHCP Server Not Available
DHCP Lease Expires Not Available
DHCP Lease Obtained Not Available
MAC Address Not Available
Service Name Raspti
Driver c:\winnt\system32\drivers\raspti.sys (16880, 5.00.2146.1)

Name [00000004] WAN Miniport (IP)
Adapter Type Not Available
Product Name WAN Miniport (IP)
Installed True
PNP Device ID ROOT\MS_NDISWANIP\0000
Last Reset 10/25/2002 4:01:29 AM
Index 4
Service Name NdisWan
IP Address Not Available
IP Subnet Not Available
Default IP Gateway Not Available
DHCP Enabled False
DHCP Server Not Available
DHCP Lease Expires Not Available
DHCP Lease Obtained Not Available
MAC Address Not Available
Service Name NdisWan
Driver c:\winnt\system32\drivers\ndiswan.sys (90768, 5.00.2184.1)

Name [00000005] Intel 82544EI-based XT Gigabit Adapter
Adapter Type Not Available
Product Name Intel 82544EI-based XT Gigabit Adapter
Installed True
PNP Device ID
PCI\VEN_8086&DEV_1008&SUBSYS_011C1028&REV_02\3&29E81982&0&10
Last Reset 10/25/2002 4:01:29 AM
Index 5
Service Name E1000
IP Address Not Available
IP Subnet Not Available
Default IP Gateway Not Available
DHCP Enabled True
DHCP Server Not Available
DHCP Lease Expires Not Available
DHCP Lease Obtained Not Available
MAC Address Not Available
Service Name E1000
Driver c:\winnt\system32\drivers\e1000nt5.sys (73696,
3.40.340.0000)

Appendix C – Tunable Parameters

Name [00000006] Intel(R) PRO/100 S Server Adapter
Adapter Type Ethernet 802.3
Product Name Intel(R) PRO/100 S Server Adapter
Installed True
PNP Device ID
PCI\VEN_8086&DEV_1229&SUBSYS_10508086&REV_0D\3&13C0B0C5&0&20
Last Reset 10/25/2002 4:01:29 AM
Index 6
Service Name E100B
IP Address 192.1.10.100
IP Subnet 255.255.255.0
Default IP Gateway Not Available
DHCP Enabled False
DHCP Server Not Available
DHCP Lease Expires Not Available
DHCP Lease Obtained Not Available
MAC Address 00:02:B3:89:63:82
Service Name E100B
IRQ Number 17
I/O Port 0xECC0-0xECFF
Driver c:\winnt\system32\drivers\e100bnt5.sys (123152,
5.41.27.0000)

Name [00000007] Intel(R) PRO/100 S Server Adapter
Adapter Type Ethernet 802.3
Product Name Intel(R) PRO/100 S Server Adapter
Installed True
PNP Device ID
PCI\VEN_8086&DEV_1229&SUBSYS_10508086&REV_0D\3&13C0B0C5&0&30
Last Reset 10/25/2002 4:01:29 AM
Index 7
Service Name E100B
IP Address 192.1.1.1
IP Subnet 255.255.255.0
Default IP Gateway Not Available
DHCP Enabled False
DHCP Server Not Available
DHCP Lease Expires Not Available
DHCP Lease Obtained Not Available
MAC Address 00:02:B3:8C:F2:98
Service Name E100B
IRQ Number 20
I/O Port 0xEC80-0xECBF
Driver c:\winnt\system32\drivers\e100bnt5.sys (123152,
5.41.27.0000)

[Protocol]

Item Value
Name MSAFD Tcpi [TCP/IP]
ConnectionlessService False
GuaranteesDelivery True
GuaranteesSequencing True

Appendix C – Tunable Parameters

MaximumAddressSize 16 bytes
MaximumMessageSize 0 bytes
MessageOriented False
MinimumAddressSize 16 bytes
PseudoStreamOriented False
SupportsBroadcasting False
SupportsConnectData False
SupportsDisconnectData False
SupportsEncryption False
SupportsExpeditedData True
SupportsGracefulClosing True
SupportsGuaranteedBandwidth False
SupportsMulticasting False

Name MSAFD Tcpi [UDP/IP]
ConnectionlessService True
GuaranteesDelivery False
GuaranteesSequencing False
MaximumAddressSize 16 bytes
MaximumMessageSize 65467 bytes
MessageOriented True
MinimumAddressSize 16 bytes
PseudoStreamOriented False
SupportsBroadcasting True
SupportsConnectData False
SupportsDisconnectData False
SupportsEncryption False
SupportsExpeditedData False
SupportsGracefulClosing False
SupportsGuaranteedBandwidth False
SupportsMulticasting True

Name RSVP UDP Service Provider
ConnectionlessService True
GuaranteesDelivery False
GuaranteesSequencing False
MaximumAddressSize 16 bytes
MaximumMessageSize 65467 bytes
MessageOriented True
MinimumAddressSize 16 bytes
PseudoStreamOriented False
SupportsBroadcasting True
SupportsConnectData False
SupportsDisconnectData False
SupportsEncryption True
SupportsExpeditedData False
SupportsGracefulClosing False
SupportsGuaranteedBandwidth False
SupportsMulticasting True

Name RSVP TCP Service Provider
ConnectionlessService False
GuaranteesDelivery True
GuaranteesSequencing True
MaximumAddressSize 16 bytes

Appendix C – Tunable Parameters

MaximumMessageSize 0 bytes
MessageOriented False
MinimumAddressSize 16 bytes
PseudoStreamOriented False
SupportsBroadcasting False
SupportsConnectData False
SupportsDisconnectData False
SupportsEncryption True
SupportsExpeditedData True
SupportsGracefulClosing True
SupportsGuaranteedBandwidth False
SupportsMulticasting False

Name MSAFD NetBIOS [\Device\NetBT_Tcpip_{3E4E49AF-0B8F-46D4-AD06-B595EC94A4C3}] SEQPACKET 4

ConnectionlessService False
GuaranteesDelivery True
GuaranteesSequencing True
MaximumAddressSize 20 bytes
MaximumMessageSize 64000 bytes
MessageOriented True
MinimumAddressSize 20 bytes
PseudoStreamOriented False
SupportsBroadcasting False
SupportsConnectData False
SupportsDisconnectData False
SupportsEncryption False
SupportsExpeditedData False
SupportsGracefulClosing False
SupportsGuaranteedBandwidth False
SupportsMulticasting False

Name MSAFD NetBIOS [\Device\NetBT_Tcpip_{3E4E49AF-0B8F-46D4-AD06-B595EC94A4C3}] DATAGRAM 4

ConnectionlessService True
GuaranteesDelivery False
GuaranteesSequencing False
MaximumAddressSize 20 bytes
MaximumMessageSize 64000 bytes
MessageOriented True
MinimumAddressSize 20 bytes
PseudoStreamOriented False
SupportsBroadcasting True
SupportsConnectData False
SupportsDisconnectData False
SupportsEncryption False
SupportsExpeditedData False
SupportsGracefulClosing False
SupportsGuaranteedBandwidth False
SupportsMulticasting False

Name MSAFD NetBIOS [\Device\NetBT_Tcpip_{3C8CADDf-D7E4-4BA8-B1D9-969B42211330}] SEQPACKET 3

ConnectionlessService False
GuaranteesDelivery True

Appendix C – Tunable Parameters

GuaranteesSequencing True
MaximumAddressSize 20 bytes
MaximumMessageSize 64000 bytes
MessageOriented True
MinimumAddressSize 20 bytes
PseudoStreamOriented False
SupportsBroadcasting False
SupportsConnectData False
SupportsDisconnectData False
SupportsEncryption False
SupportsExpeditedData False
SupportsGracefulClosing False
SupportsGuaranteedBandwidth False
SupportsMulticasting False

Name MSAFD NetBIOS [\Device\NetBT_Tcpip_{3C8CADDf-D7E4-4BA8-B1D9-969B42211330}] DATAGRAM 3
ConnectionlessService True
GuaranteesDelivery False
GuaranteesSequencing False
MaximumAddressSize 20 bytes
MaximumMessageSize 64000 bytes
MessageOriented True
MinimumAddressSize 20 bytes
PseudoStreamOriented False
SupportsBroadcasting True
SupportsConnectData False
SupportsDisconnectData False
SupportsEncryption False
SupportsExpeditedData False
SupportsGracefulClosing False
SupportsGuaranteedBandwidth False
SupportsMulticasting False

Name MSAFD NetBIOS [\Device\NetBT_Tcpip_{67D62213-4A1D-4A86-9ADF-EF52C0C1F8DF}] SEQPACKET 0
ConnectionlessService False
GuaranteesDelivery True
GuaranteesSequencing True
MaximumAddressSize 20 bytes
MaximumMessageSize 64000 bytes
MessageOriented True
MinimumAddressSize 20 bytes
PseudoStreamOriented False
SupportsBroadcasting False
SupportsConnectData False
SupportsDisconnectData False
SupportsEncryption False
SupportsExpeditedData False
SupportsGracefulClosing False
SupportsGuaranteedBandwidth False
SupportsMulticasting False

Name MSAFD NetBIOS [\Device\NetBT_Tcpip_{67D62213-4A1D-4A86-9ADF-EF52C0C1F8DF}] DATAGRAM 0

Appendix C – Tunable Parameters

ConnectionlessService True
GuaranteesDelivery False
GuaranteesSequencing False
MaximumAddressSize 20 bytes
MaximumMessageSize 64000 bytes
MessageOriented True
MinimumAddressSize 20 bytes
PseudoStreamOriented False
SupportsBroadcasting True
SupportsConnectData False
SupportsDisconnectData False
SupportsEncryption False
SupportsExpeditedData False
SupportsGracefulClosing False
SupportsGuaranteedBandwidth False
SupportsMulticasting False

Name MSAFD NetBIOS [\Device\NetBT_Tcpip_{6457AAC4-5D98-4B79-8F6C-8D234A496C87}] SEQPACKET 1

ConnectionlessService False
GuaranteesDelivery True
GuaranteesSequencing True
MaximumAddressSize 20 bytes
MaximumMessageSize 64000 bytes
MessageOriented True
MinimumAddressSize 20 bytes
PseudoStreamOriented False
SupportsBroadcasting False
SupportsConnectData False
SupportsDisconnectData False
SupportsEncryption False
SupportsExpeditedData False
SupportsGracefulClosing False
SupportsGuaranteedBandwidth False
SupportsMulticasting False

Name MSAFD NetBIOS [\Device\NetBT_Tcpip_{6457AAC4-5D98-4B79-8F6C-8D234A496C87}] DATAGRAM 1

ConnectionlessService True
GuaranteesDelivery False
GuaranteesSequencing False
MaximumAddressSize 20 bytes
MaximumMessageSize 64000 bytes
MessageOriented True
MinimumAddressSize 20 bytes
PseudoStreamOriented False
SupportsBroadcasting True
SupportsConnectData False
SupportsDisconnectData False
SupportsEncryption False
SupportsExpeditedData False
SupportsGracefulClosing False
SupportsGuaranteedBandwidth False
SupportsMulticasting False

Appendix C – Tunable Parameters

Name MSAFD NetBIOS [\Device\NetBT_Tcpip_{0630F94E-070D-4D57-8C49-676CC7BF20DE}] SEQPACKET 2

ConnectionlessService	False
GuaranteesDelivery	True
GuaranteesSequencing	True
MaximumAddressSize	20 bytes
MaximumMessageSize	64000 bytes
MessageOriented	True
MinimumAddressSize	20 bytes
PseudoStreamOriented	False
SupportsBroadcasting	False
SupportsConnectData	False
SupportsDisconnectData	False
SupportsEncryption	False
SupportsExpeditedData	False
SupportsGracefulClosing	False
SupportsGuaranteedBandwidth	False
SupportsMulticasting	False

Name MSAFD NetBIOS [\Device\NetBT_Tcpip_{0630F94E-070D-4D57-8C49-676CC7BF20DE}] DATAGRAM 2

ConnectionlessService	True
GuaranteesDelivery	False
GuaranteesSequencing	False
MaximumAddressSize	20 bytes
MaximumMessageSize	64000 bytes
MessageOriented	True
MinimumAddressSize	20 bytes
PseudoStreamOriented	False
SupportsBroadcasting	True
SupportsConnectData	False
SupportsDisconnectData	False
SupportsEncryption	False
SupportsExpeditedData	False
SupportsGracefulClosing	False
SupportsGuaranteedBandwidth	False
SupportsMulticasting	False

[WinSock]

Item	Value
File	c:\winnt\system32\winsock.dll
Version	3.10
Size	2.80 KB (2,864 bytes)

File	c:\winnt\system32\wsock32.dll
Version	5.00.2195.1207
Size	21.27 KB (21,776 bytes)

[Ports]

[Following are sub-categories of this main category]

Appendix C – Tunable Parameters

[Serial]

```
Item Value
Name COM1
Status OK
PNP Device ID ACPI\PNP0501\1
Maximum Input Buffer Size Not Available
Maximum Output Buffer Size Not Available
Settable Baud Rate Not Available
Settable Data Bits Not Available
Settable Flow Control Not Available
Settable Parity Not Available
Settable Parity Check Not Available
Settable Stop Bits Not Available
Settable RLSO Not Available
Supports RLSO Not Available
Supports 16 Bit Mode Not Available
Supports Special Characters Not Available
Baud Rate 9600
Bits/Byte 8
Stop Bits 1
Parity None
Busy -1
Abort Read/Write on Error Not Available
Binary Mode Enabled Not Available
Continue Xmit on XOff Not Available
CTS Outflow Control Not Available
Discard NULL Bytes Not Available
DSR Outflow Control Not Available
DSR Sensitivity Not Available
DTR Flow Control Type Not Available
EOF Character Not Available
Error Replace Character Not Available
Error Replacement Enabled Not Available
Event Character Not Available
Parity Check Enabled -1
RTS Flow Control Type Not Available
XOff Character 19
XOffXmit Threshold 512
XOn Character 17
XOnXmit Threshold 2048
XOnXOff InFlow Control Not Available
XOnXOff OutFlow Control Not Available
IRQ Number 4
I/O Port 0x03F8-0x03FF
Driver c:\winnt\system32\drivers\serial.sys (62448, 5.00.2134.1)
```

[Parallel]

```
Item Value
Name LPT1
PNP Device ID ACPI\PNP0401\4&639D4DC&0
```

Appendix C – Tunable Parameters

[Storage]

[Following are sub-categories of this main category]

[Drives]

Item Value

Drive A:

Description 3 1/2 Inch Floppy Drive

Drive C:

Description Local Fixed Disk

Compressed False

File System NTFS

Size 16.95 GB (18,202,509,312 bytes)

Free Space 14.42 GB (15,484,764,160 bytes)

Volume Name

Volume Serial Number 309C10C1

Partition Disk #0, Partition #0

Partition Size 16.95 GB (18,202,512,384 bytes)

Starting Offset 32256 bytes

Drive Description Disk drive

Drive Manufacturer (Standard disk drives)

Drive Model SEAGATE ST318203LC SCSI Disk Device

Drive BytesPerSector 512

Drive MediaLoaded True

Drive MediaType Fixed hard disk media

Drive Partitions 1

Drive SCsIBus 0

Drive SCsILogicalUnit 0

Drive SCsIPort 2

Drive SCsITargetId 0

Drive SectorsPerTrack 63

Drive Size 18202544640 bytes

Drive TotalCylinders 2213

Drive TotalSectors 35551845

Drive TotalTracks 564315

Drive TracksPerCylinder 255

Drive E:

Description Network Connection

Provider Name \\client1\c\$

[SCSI]

Item Value

Name Adaptec AIC-7899 Ultra160/m PCI SCSI Card

Caption Adaptec AIC-7899 Ultra160/m PCI SCSI Card

Driver adpul60m

Status OK

PNP Device ID

PCI\VEN_9005&DEV_00CF&SUBSYS_011C1028&REV_01\3&1070020&0&10

Device ID PCI\VEN_9005&DEV_00CF&SUBSYS_011C1028&REV_01\3&1070020&0&10

Device Map Not Available

Appendix C – Tunable Parameters

Index Not Available

Max Number Controlled Not Available

IRQ Number 29

I/O Port 0xDC00-0xDCFF

Driver c:\winnt\system32\drivers\adpu160m.sys (64432, v3.10a)

Name Adaptec AIC-7899 Ultra160/m PCI SCSI Card

Caption Adaptec AIC-7899 Ultra160/m PCI SCSI Card

Driver adpu160m

Status OK

PNP Device ID

PCI\VEN_9005&DEV_00CF&SUBSYS_011C1028&REV_01\3&1070020&0&11

Device ID PCI\VEN_9005&DEV_00CF&SUBSYS_011C1028&REV_01\3&1070020&0&11

Device Map Not Available

Index Not Available

Max Number Controlled Not Available

IRQ Number 30

I/O Port 0xD800-0xD8FF

Driver c:\winnt\system32\drivers\adpu160m.sys (64432, v3.10a)

[Printing]

Name Port Name Server Name

No printing information

[Problem Devices]

Device PNP Device ID Error Code

Intel 82544EI-based XT Gigabit Adapter

PCI\VEN_8086&DEV_1008&SUBSYS_011C1028&REV_02\3&29E81982&0&1022

[USB]

Device PNP Device ID

Standard OpenHCD USB Host Controller

PCI\VEN_1166&DEV_0220&SUBSYS_02201166&REV_05\3&13C0B0C5&0&7A

USB Root Hub USB\ROOT_HUB\4&1A0F8909&0

[Software Environment]

[Following are sub-categories of this main category]

[Drivers]

Name	Description	File	Type	Started	Start Mode	State	Status
	Error Control		Accept	Pause		Accept	Stop
abiosdsk	Abiosdsk		Not Available		Kernel Driver		False
	Disabled	Stopped	OK	Ignore	False	False	
abp480n5	abp480n5		Not Available		Kernel Driver		False
	Disabled	Stopped	OK	Normal	False	False	
acpi	Microsoft ACPI Driver	c:\winnt\system32\drivers\acpi.sys					
	Kernel Driver	True	Boot	Running	OK	Normal	False
	True						

Appendix C – Tunable Parameters

```

acpiec      ACPIEC      c:\winnt\system32\drivers\acpiec.sys
            Kernel Driver  False Disabled   Stopped   OK      Normal
            False False
adpu160m    adpu160m    c:\winnt\system32\drivers\adpu160m.sys
            Kernel Driver  True  Boot  Running   OK      Normal      False
            True
afd         AFD Networking Support Environment
            c:\winnt\system32\drivers\afd.sys  Kernel Driver  True  Auto
            Running   OK      Normal   False True
aha154x     Aha154x     Not Available  Kernel Driver  False
            Disabled  Stopped  OK      Normal   False False
aic116x     aic116x     Not Available  Kernel Driver  False
            Disabled  Stopped  OK      Normal   False False
aic78u2     aic78u2     Not Available  Kernel Driver  False
            Disabled  Stopped  OK      Normal   False False
aic78xx     aic78xx     Not Available  Kernel Driver  False
            Disabled  Stopped  OK      Normal   False False
ami0nt     ami0nt     Not Available  Kernel Driver  False
            Disabled  Stopped  OK      Normal   False False
amsint     amsint     Not Available  Kernel Driver  False
            Disabled  Stopped  OK      Normal   False False
asc         asc  Not Available  Kernel Driver  False Disabled
            Stopped   OK      Normal   False False
asc3350p    asc3350p    Not Available  Kernel Driver  False
            Disabled  Stopped  OK      Normal   False False
asc3550     asc3550     Not Available  Kernel Driver  False
            Disabled  Stopped  OK      Normal   False False
asyncmac   RAS Asynchronous Media Driver
            c:\winnt\system32\drivers\asyncmac.sys  Kernel Driver  False
            Manual    Stopped  OK      Normal   False False
ataapi     Standard IDE/ESDI Hard Disk Controller
            c:\winnt\system32\drivers\ataapi.sys  Kernel Driver  True  Boot
            Running   OK      Normal   False True
atdisk     Atdisk     Not Available  Kernel Driver  False
            Disabled  Stopped  OK      Ignore   False False
atirage3   atirage3   c:\winnt\system32\drivers\atimpab.sys
            Kernel Driver  True  Manual   Running   OK      Ignore
            False True
atmarpc    ATM ARP Client Protocol
            c:\winnt\system32\drivers\atmarpc.sys  Kernel Driver  False
            Manual    Stopped  OK      Normal   False False
audstub    Audio Stub Driver c:\winnt\system32\drivers\audstub.sys
            Kernel Driver  True  Manual   Running   OK      Normal
            False True
beep       Beep  c:\winnt\system32\drivers\beep.sys  Kernel Driver  True
            System     Running  OK      Normal   False True
buslogic   BusLogic  Not Available  Kernel Driver  False
            Disabled  Stopped  OK      Normal   False False
cd20xrnt   cd20xrnt   Not Available  Kernel Driver  False
            Disabled  Stopped  OK      Normal   False False
cdaudio    Cdaudio    c:\winnt\system32\drivers\cdaudio.sys
            Kernel Driver  False System  Stopped   OK      Ignore
            False False
cdfsf      Cdfs  c:\winnt\system32\drivers\cdfsf.sys  File System Driver
            True  Disabled  Running  OK      Normal   False True

```

Appendix C – Tunable Parameters

cdrom	CD-ROM Driver	c:\winnt\system32\drivers\cdrom.sys	Kernel Driver	True	System	Running	OK	Normal	False	True
changer	Changer	Not Available	Kernel Driver	False	System	Stopped	OK	Ignore	False	False
cpqarray	Cpqarray	Not Available	Kernel Driver	False	Disabled	Stopped	OK	Normal	False	False
cpqarray2	cpqarray2	Not Available	Kernel Driver	False	Disabled	Stopped	OK	Normal	False	False
cpqfcalm	cpqfcalm	Not Available	Kernel Driver	False	Disabled	Stopped	OK	Normal	False	False
cpqfws2e	cpqfws2e	Not Available	Kernel Driver	False	Disabled	Stopped	OK	Normal	False	False
dac960nt	dac960nt	Not Available	Kernel Driver	False	Disabled	Stopped	OK	Normal	False	False
deckzpsx	deckzpsx	Not Available	Kernel Driver	False	Disabled	Stopped	OK	Normal	False	False
dfsdriver	DfsDriver	c:\winnt\system32\drivers\dfs.sys	File System Driver	True	Boot	Running	OK	Normal	False	True
disk	Disk Driver	c:\winnt\system32\drivers\disk.sys	Kernel Driver	True	Boot	Running	OK	Normal	False	True
diskperf	Diskperf	c:\winnt\system32\drivers\diskperf.sys	Kernel Driver	True	Boot	Running	OK	Normal	False	True
dmboot	dmboot	c:\winnt\system32\drivers\dmboot.sys	Kernel Driver	False	Disabled	Stopped	OK	Normal	False	False
dmio	Logical Disk Manager Driver	c:\winnt\system32\drivers\dmio.sys	Kernel Driver	True	Boot	Running	OK	Normal	False	True
dmload	dmload	c:\winnt\system32\drivers\dmload.sys	Kernel Driver	True	Boot	Running	OK	Normal	False	True
e1000	Intel(R) PRO/1000 Adapter Driver	c:\winnt\system32\drivers\e1000nt5.sys	Kernel Driver	Manual	Stopped	OK	Normal	False	False	False
e100b	Intel(R) PRO Adapter Driver	c:\winnt\system32\drivers\e100bnt5.sys	Kernel Driver	Manual	Running	OK	Normal	False	True	True
efs	EFS	c:\winnt\system32\drivers\efs.sys	File System Driver	True	Disabled	Running	OK	Normal	False	True
fastfat	Fastfat	c:\winnt\system32\drivers\fastfat.sys	File System Driver	True	Disabled	Running	OK	Normal	False	True
fd16_700	Fd16_700	Not Available	Kernel Driver	Disabled	Stopped	OK	Normal	False	False	False
fdc	Floppy Disk Controller Driver	c:\winnt\system32\drivers\fdc.sys	Kernel Driver	True	Manual	Running	OK	Normal	False	True
fireport	fireport	Not Available	Kernel Driver	Disabled	Stopped	OK	Normal	False	False	False
flashpnt	flashpnt	Not Available	Kernel Driver	Disabled	Stopped	OK	Normal	False	False	False
flpydisk	Floppy Disk Driver	c:\winnt\system32\drivers\flpydisk.sys	Kernel Driver	Manual	Running	OK	Normal	False	True	True

Appendix C – Tunable Parameters

```

ftdisk      Volume Manager Driver
             c:\winnt\system32\drivers\ftdisk.sys      Kernel Driver      True
             Boot Running      OK      Normal      False True
gpc         Generic Packet Classifier      c:\winnt\system32\drivers\msgpc.sys
             Kernel Driver      True Manual      Running      OK      Normal
             False True
i8042prt    i8042 Keyboard and PS/2 Mouse Port Driver
             c:\winnt\system32\drivers\i8042prt.sys    Kernel Driver      True
             System      Running      OK      Normal      False True
ini910u     ini910u      Not Available      Kernel Driver      False
             Disabled      Stopped      OK      Normal      False False
intelide    IntelIde      Not Available      Kernel Driver      False
             Disabled      Stopped      OK      Normal      False False
ipfilterdriver  IP Traffic Filter Driver
             c:\winnt\system32\drivers\ipfltdrv.sys    Kernel Driver      False
             Manual      Stopped      OK      Normal      False False
ipinip      IP in IP Tunnel Driver
             c:\winnt\system32\drivers\ipinip.sys      Kernel Driver      False
             Manual      Stopped      OK      Normal      False False
ipnat      IP Network Address Translator c:\winnt\system32\drivers\ipnat.sys
             Kernel Driver      False Manual      Stopped      OK      Normal
             False False
ipsec      IPSEC driver      c:\winnt\system32\drivers\ipsec.sys Kernel
Driver      False Manual      Stopped      OK      Normal      False False
ipsraidn   ipsraidn      Not Available      Kernel Driver      False
             Disabled      Stopped      OK      Normal      False False
isapnp     PnP ISA/EISA Bus Driver
             c:\winnt\system32\drivers\isapnp.sys      Kernel Driver      True
             Boot Running      OK      Critical      False True
kbdclass   Keyboard Class Driver
             c:\winnt\system32\drivers\kbdclass.sys    Kernel Driver      True
             System      Running      OK      Normal      False True
ksecdd     KSecDD      c:\winnt\system32\drivers\ksecdd.sys
             Kernel Driver      True Boot Running      OK      Normal      False
             True
lbrtfdc    lbrtfdc      Not Available      Kernel Driver      False
             System      Stopped      OK      Ignore      False False
lp6nds35   lp6nds35      Not Available      Kernel Driver      False
             Disabled      Stopped      OK      Normal      False False
mmdd      mmdd      c:\winnt\system32\drivers\mmdd.sys Kernel Driver      True
             System      Running      OK      Ignore      False True
modem      Modem      c:\winnt\system32\drivers\modem.sys Kernel Driver      False
             Manual      Stopped      OK      Ignore      False False
mouclass   Mouse Class Driver
             c:\winnt\system32\drivers\mouclass.sys    Kernel Driver      True
             System      Running      OK      Normal      False True
mountmgr   MountMgr      c:\winnt\system32\drivers\mountmgr.sys
             Kernel Driver      True Boot Running      OK      Normal      False
             True
mraid35x   mraid35x      Not Available      Kernel Driver      False
             Disabled      Stopped      OK      Normal      False False
mrxsmb     MRXSMB      c:\winnt\system32\drivers\mrxsmb.sys      File
System Driver      True System      Running      OK      Normal      False
             True

```

Appendix C – Tunable Parameters

```

msfs Msfs c:\winnt\system32\drivers\msfs.sys File System Driver
    True System Running OK Normal False True
mskssrv Microsoft Streaming Service Proxy
    c:\winnt\system32\drivers\mskssrv.sys Kernel Driver False
    Manual Stopped OK Normal False False
mspclock Microsoft Streaming Clock Proxy
    c:\winnt\system32\drivers\mspclock.sys Kernel Driver False
    Manual Stopped OK Normal False False
mbspqm Microsoft Streaming Quality Manager Proxy
    c:\winnt\system32\drivers\mbspqm.sys Kernel Driver False
    Manual Stopped OK Normal False False
mup Mup c:\winnt\system32\drivers\mup.sys File System Driver
    True Boot Running OK Normal False True
ncrc710 Ncrc710 Not Available Kernel Driver False
    Disabled Stopped OK Normal False False
ndis NDIS System Driver c:\winnt\system32\drivers\ndis.sys
    Kernel Driver True Boot Running OK Normal False
    True
ndistapi Remote Access NDIS TAPI Driver
    c:\winnt\system32\drivers\ndistapi.sys Kernel Driver True
    Manual Running OK Normal False True
ndiswan Remote Access NDIS WAN Driver
    c:\winnt\system32\drivers\ndiswan.sys Kernel Driver True
    Manual Running OK Normal False True
ndproxy NDIS Proxy c:\winnt\system32\drivers\ndproxy.sys
    Kernel Driver True Manual Running OK Normal
    False True
netbios NetBIOS Interface c:\winnt\system32\drivers\netbios.sys
    File System Driver True System Running OK
    Normal False True
netbt NetBios over Tcpip c:\winnt\system32\drivers\netbt.sys
    Kernel Driver True System Running OK Normal
    False True
netdetect NetDetect c:\winnt\system32\drivers\netdetect.sys
    Kernel Driver False Manual Stopped OK Normal
    False False
npfs Npfs c:\winnt\system32\drivers\npfs.sys File System Driver
    True System Running OK Normal False True
ntfs Ntfs c:\winnt\system32\drivers\ntfs.sys File System Driver
    True Disabled Running OK Normal False True
null Null c:\winnt\system32\drivers\null.sys Kernel Driver True
    System Running OK Normal False True
nwnlkflt IPX Traffic Filter Driver
    c:\winnt\system32\drivers\nwnlkflt.sys Kernel Driver False
    Manual Stopped OK Normal False False
nwnlkfwd IPX Traffic Forwarder Driver
    c:\winnt\system32\drivers\nwnlkfwd.sys Kernel Driver False
    Manual Stopped OK Normal False False
openhci Microsoft USB Open Host Controller Driver
    c:\winnt\system32\drivers\openhci.sys Kernel Driver True
    Manual Running OK Normal False True
parallel Parallel class driver
    c:\winnt\system32\drivers\parallel.sys Kernel Driver True
    Manual Running OK Normal False True

```

Appendix C – Tunable Parameters

```

parport      Parallel port driver
              c:\winnt\system32\drivers\parport.sys      Kernel Driver      True
              System      Running      OK      Ignore      False True
partmgr      PartMgr      c:\winnt\system32\drivers\partmgr.sys
              Kernel Driver      True Boot Running      OK      Normal      False
              True
parvdm       ParVdm      c:\winnt\system32\drivers\parvdm.sys
              Kernel Driver      True Auto Running      OK      Ignore      False
              True
pci          PCI Bus Driver      c:\winnt\system32\drivers\pci.sys      Kernel
Driver      True Boot Running      OK      Critical      False True
pcidump      PCIDump      Not Available      Kernel Driver      False
              System      Stopped      OK      Ignore      False False
pciide       PCIIde      c:\winnt\system32\drivers\pciide.sys
              Kernel Driver      True Boot Running      OK      Normal      False
              True
pcmcia       Pcmcia      c:\winnt\system32\drivers\pcmcia.sys
              Kernel Driver      False Disabled      Stopped      OK      Normal
              False False
pdcomp       PDCOMP      Not Available      Kernel Driver      False
              Manual      Stopped      OK      Ignore      False False
pdframe      PDFRAME      Not Available      Kernel Driver      False
              Manual      Stopped      OK      Ignore      False False
pdreli       PDRELI      Not Available      Kernel Driver      False
              Manual      Stopped      OK      Ignore      False False
pdrframe     PDRFRAME      Not Available      Kernel Driver      False
              Manual      Stopped      OK      Ignore      False False
pptpminiport      WAN Miniport (PPTP)
              c:\winnt\system32\drivers\raspttp.sys      Kernel Driver      True
              Manual      Running      OK      Normal      False True
ptilink      Direct Parallel Link Driver
              c:\winnt\system32\drivers\ptilink.sys      Kernel Driver      True
              Manual      Running      OK      Normal      False True
ql1080       ql1080      Not Available      Kernel Driver      False
              Disabled      Stopped      OK      Normal      False False
ql10wnt      Ql10wnt      Not Available      Kernel Driver      False
              Disabled      Stopped      OK      Normal      False False
ql1240       ql1240      Not Available      Kernel Driver      False
              Disabled      Stopped      OK      Normal      False False
ql2100       ql2100      Not Available      Kernel Driver      False
              Disabled      Stopped      OK      Normal      False False
rasacd       Remote Access Auto Connection Driver
              c:\winnt\system32\drivers\rasacd.sys      Kernel Driver      True
              System      Running      OK      Normal      False True
rasl2tp      WAN Miniport (L2TP)
              c:\winnt\system32\drivers\rasl2tp.sys      Kernel Driver      True
              Manual      Running      OK      Normal      False True
raspti       Direct Parallel      c:\winnt\system32\drivers\raspti.sys
Kernel Driver      True Manual      Running      OK      Normal
False True
rca          Microsoft Streaming Network Raw Channel Access
              c:\winnt\system32\drivers\rca.sys      Kernel Driver      False
              Manual      Stopped      OK      Normal      False False
rdbss        Rdbss      c:\winnt\system32\drivers\rdbss.sys      File System Driver
              True System      Running      OK      Normal      False True

```

Appendix C – Tunable Parameters

rdpwd	RDPWD	c:\winnt\system32\drivers\rdpwd.sys	Kernel Driver	False	False	False	False
	Manual	Stopped	OK	Ignore	False	False	
redbook	Digital CD Audio Playback Filter Driver						
		c:\winnt\system32\drivers\redbook.sys	Kernel Driver	False	False	False	False
	System	Stopped	OK	Normal	False	False	
serenum	Serenum Filter Driver						
		c:\winnt\system32\drivers\serenum.sys	Kernel Driver	True	True	False	True
	Manual	Running	OK	Normal	False	True	
serial	Serial port driver						
		c:\winnt\system32\drivers\serial.sys	Kernel Driver	True	True	False	True
	System	Running	OK	Ignore	False	True	
sfloppy	Sfloppy	c:\winnt\system32\drivers\sfloppy.sys	Kernel Driver	False	System	Stopped	OK
	Kernel Driver	False	System	Stopped	OK	Ignore	
	False	False					
sglfb	sglfb Not Available		Kernel Driver	False	System		
	Stopped	OK	Normal	False	False		
simbad	Simbad	Not Available	Kernel Driver	False	False		
	Disabled	Stopped	OK	Normal	False	False	
sparrow	Sparrow	Not Available	Kernel Driver	False	False		
	Disabled	Stopped	OK	Normal	False	False	
spud	Special Purpose Utility Driver						
		c:\winnt\system32\drivers\spud.sys	Kernel Driver	True	True	False	True
	Manual	Running	OK	Normal	False	True	
srv	Srv	c:\winnt\system32\drivers\srv.sys	File System Driver	True	Manual	Running	OK
	True	Manual	Running	OK	Normal	False	True
swenum	Software Bus Driver						
		c:\winnt\system32\drivers\swenum.sys	Kernel Driver	True	True	False	True
	Manual	Running	OK	Normal	False	True	
symc810	symc810	Not Available	Kernel Driver	False	False		
	Disabled	Stopped	OK	Normal	False	False	
symc8xx	symc8xx	Not Available	Kernel Driver	False	False		
	Disabled	Stopped	OK	Normal	False	False	
sym_hi	sym_hi	Not Available	Kernel Driver	False	False		
	Disabled	Stopped	OK	Normal	False	False	
tcpip	TCP/IP Protocol Driver	c:\winnt\system32\drivers\tcpip.sys	Kernel Driver	True	System	Running	OK
	Kernel Driver	True	System	Running	OK	Normal	
	False	True					
tdasync	TDASYNC	c:\winnt\system32\drivers\tdasync.sys	Kernel Driver	False	Manual	Stopped	OK
	Kernel Driver	False	Manual	Stopped	OK	Ignore	
	False	False					
tdipx	TDIPX	c:\winnt\system32\drivers\tdipx.sys	Kernel Driver	False	False	False	False
	Manual	Stopped	OK	Ignore	False	False	
tdnetb	TDNETB	c:\winnt\system32\drivers\tdnetb.sys	Kernel Driver	False	Manual	Stopped	OK
	Kernel Driver	False	Manual	Stopped	OK	Ignore	
	False	False					
tdpipe	TDPIPE	c:\winnt\system32\drivers\tdpipe.sys	Kernel Driver	False	Manual	Stopped	OK
	Kernel Driver	False	Manual	Stopped	OK	Ignore	
	False	False					
tdspx	TDSPX	c:\winnt\system32\drivers\tdspx.sys	Kernel Driver	False	False	False	False
	Manual	Stopped	OK	Ignore	False	False	
tdtcp	TDTCP	c:\winnt\system32\drivers\tdtcp.sys	Kernel Driver	False	False	False	False
	Manual	Stopped	OK	Ignore	False	False	
termdd	Terminal Device Driver						
		c:\winnt\system32\drivers\termdd.sys	Kernel Driver	False	False	False	False
	Disabled	Stopped	OK	Normal	False	False	

Appendix C – Tunable Parameters

```

tga    tga    Not Available    Kernel Driver    False System
        Stopped    OK    Ignore    False False
udfs   Udfs   c:\winnt\system32\drivers\udfs.sys  File System Driver
        False Disabled    Stopped    OK    Normal    False False
ultra66    ultra66    Not Available    Kernel Driver    False
        Disabled    Stopped    OK    Normal    False False
update    Microcode Update Driver
        c:\winnt\system32\drivers\update.sys    Kernel Driver    True
        Manual    Running    OK    Normal    False True
usbhub   Microsoft USB Standard Hub Driver
        c:\winnt\system32\drivers\usbhub.sys    Kernel Driver    True
        Manual    Running    OK    Normal    False True
vgasave VgaSave    c:\winnt\system32\drivers\vga.sys    Kernel
Driver   True System    Running    OK    Ignore    False True
wanarp   Remote Access IP ARP Driver
        c:\winnt\system32\drivers\wanarp.sys    Kernel Driver    True
        Manual    Running    OK    Normal    False True
wdica   WDICA Not Available    Kernel Driver    False Manual
        Stopped    OK    Ignore    False False

```

[Environment Variables]

```

Variable    Value User Name
ComSpec     %SystemRoot%\system32\cmd.exe <SYSTEM>
HOME        C:/    <SYSTEM>
NUMBER_OF_PROCESSORS    1    <SYSTEM>
OS          Windows_NT <SYSTEM>
Os2LibPath  %SystemRoot%\system32\os2\dll;    <SYSTEM>
Path        C:\mksnt;C:\WINNT\system32;C:\WINNT;C:\WINNT\System32\Wbem;C:\SQL
_2K_STD\x86\bin;. ;    <SYSTEM>
PATHEXT     .COM;.EXE;.BAT;.CMD;.VBS;.VBE;.JS;.JSE;.WSF;.WSH
            <SYSTEM>
PROCESSOR_ARCHITECTURE    x86    <SYSTEM>
PROCESSOR_IDENTIFIER      x86 Family 6 Model 11 Stepping 1, GenuineIntel
            <SYSTEM>
PROCESSOR_LEVEL           6    <SYSTEM>
PROCESSOR_REVISION        0b01 <SYSTEM>
ROOTDIR                  C:/    <SYSTEM>
SHELL                    C:/mksnt/sh.exe <SYSTEM>
TEMP                     %SystemRoot%\TEMP <SYSTEM>
TMP                      %SystemRoot%\TEMP <SYSTEM>
TMPDIR                   C:/WINNT/TEMP    <SYSTEM>
windir                   %SystemRoot%    <SYSTEM>
TEMP                     %USERPROFILE%\Local Settings\Temp    CLIENT1\Administrator
TMP                      %USERPROFILE%\Local Settings\Temp    CLIENT1\Administrator

```

[Jobs]

[Following are sub-categories of this main category]

[Print]

Document	Size	Owner	Notify	Status	Time Submitted	Start
Time Until	Time	Elapsed	Time	Pages Printed	Job ID	

Appendix C – Tunable Parameters

Priority	Parameters	Driver Name	Print	Processor	Host Print
Queue Data Type	Name				
Unknown	Unknown	Unknown	Unknown	Unknown	Unknown
Unknown	Unknown	Unknown	Unknown	Unknown	Unknown
Unknown	Unknown	Unknown	Unknown	Unknown	Unknown
Unknown	Unknown				

[Network Connections]

Local Name	Remote Name	Type	Status	User Name
E:	\\client1\c\$	Disk	OK	CLIENT1\administrator

[Running Tasks]

Name	Path	Process ID	Priority	Min Working Set	Max Working Set
	Start Time	Version	Size	File Date	
system idle process			Not Available	0	0
	Not Available		Not Available	Unknown	Unknown
	Unknown				
system	Not Available	8	8	0	1413120
Available	Unknown	Unknown	Unknown		Not
smss.exe	c:\winnt\system32\smss.exe	160	11	204800	
	1413120	10/25/2002	9:01:48 AM	5.00.2195.31	44.27 KB
(45,328 bytes)	7/26/2000	7:00:00 AM			
csrss.exe	Not Available	184	13	Not Available	Not
Available	10/25/2002	9:01:51 AM	Unknown	Unknown	Unknown
winlogon.exe	c:\winnt\system32\winlogon.exe	204	13		
	204800	1413120	10/25/2002	9:01:52 AM	5.00.2195.1600
	172.77 KB (176,912 bytes)		7/26/2000	7:00:00 AM	
services.exe	c:\winnt\system32\services.exe	232	9		
	204800	1413120	10/25/2002	9:01:53 AM	5.00.2134.1
KB (88,848 bytes)	7/26/2000	7:00:00 AM			86.77
lsass.exe	c:\winnt\system32\lsass.exe	244	13	204800	
	1413120	10/25/2002	9:01:53 AM	5.00.2195.1620	32.77 KB
(33,552 bytes)	7/26/2000	7:00:00 AM			
svchost.exe	c:\winnt\system32\svchost.exe	400	8	204800	
	1413120	10/25/2002	9:01:56 AM	5.00.2134.1	7.77 KB (7,952
bytes)	7/26/2000	7:00:00 AM			
msdtc.exe	c:\winnt\system32\msdtc.exe	428	8	204800	
	1413120	10/25/2002	9:01:56 AM	1999.9.3421.3	6.77 KB
(6,928 bytes)	3/29/2002	6:39:39 AM			
svchost.exe	c:\winnt\system32\svchost.exe	532	8	204800	
	1413120	10/25/2002	9:01:57 AM	5.00.2134.1	7.77 KB (7,952
bytes)	7/26/2000	7:00:00 AM			
regsvc.exe	c:\winnt\system32\regsvc.exe	556	8	204800	
	1413120	10/25/2002	9:01:58 AM	5.00.2195.31	65.27 KB
(66,832 bytes)	7/26/2000	7:00:00 AM			
mstask.exe	c:\winnt\system32\mstask.exe	572	8	204800	
	1413120	10/25/2002	9:01:58 AM	4.71.2137.1	115.27 KB
(118,032 bytes)	3/29/2002	12:38:49 PM			
winmgmt.exe	c:\winnt\system32\wbem\winmgmt.exe	608	8	204800	
	1413120	10/25/2002	9:01:59 AM	1.50.1085.0009	192.08 KB
(196,685 bytes)	7/26/2000	7:00:00 AM			

Appendix C – Tunable Parameters

```
inetinfo.exe      c:\winnt\system32\inetsrv\inetinfo.exe    660   8
204800           1413120    10/25/2002 9:01:59 AM    5.00.0984    14.27
KB (14,608 bytes) 3/29/2002 6:39:28 AM
explorer.exe     c:\winnt\explorer.exe    844   8    204800
1413120         10/25/2002 9:02:10 AM    5.00.3103.1000    237.27 KB
(242,960 bytes)  7/26/2000 7:00:00 AM
svchost.exe     c:\winnt\system32\svchost.exe 1012  8    204800
1413120         10/25/2002 9:02:40 AM    5.00.2134.1 7.77 KB (7,952
bytes)           7/26/2000 7:00:00 AM
dllhost.exe     Not Available    668   8    Not Available    Not
Available       10/25/2002 9:06:22 AM    Unknown        Unknown        Unknown
dllhost.exe     Not Available    936   8    Not Available    Not
Available       10/25/2002 9:06:24 AM    Unknown        Unknown        Unknown
sh.exe          c:\mksnt\sh.exe    956   8    204800    1413120
10/25/2002 9:06:47 AM    5.2 build 64    271.50 KB (278,016
bytes)           3/29/2002 1:25:12 PM
mmc.exe         c:\winnt\system32\mmc.exe    928   8    204800
1413120         10/28/2002 3:04:09 PM    5.00.2153.1 589.27 KB
(603,408 bytes)  7/26/2000 7:00:00 AM
rsvp.exe       c:\winnt\system32\rsvp.exe    2060  8    204800
1413120         10/28/2002 3:04:51 PM    5.00.2167.1 172.77 KB
(176,912 bytes)  7/26/2000 7:00:00 AM
```

[Loaded Modules]

```
Name Version      Size File Date      Manufacturer      Path
traffic.dll 5.00.2139.1 30.77 KB (31,504 bytes) 7/26/2000 7:00:00 AM
Microsoft Corporation c:\winnt\system32\traffic.dll
rsvp.exe    5.00.2167.1 172.77 KB (176,912 bytes) 7/26/2000 7:00:00
AM Microsoft Corporation c:\winnt\system32\rsvp.exe
wbemprox.dll 1.50.1085.0015 40.08 KB (41,040 bytes) 7/26/2000
7:00:00 AM Microsoft Corporation c:\winnt\system32\wbem\wbemprox.dll
mlang.dll   5.00.3103.1000 510.77 KB (523,024 bytes) 7/26/2000
7:00:00 AM Microsoft Corporation c:\winnt\system32\mlang.dll
rassapi.dll 5.00.2188.1 14.27 KB (14,608 bytes) 7/26/2000 7:00:00 AM
Microsoft Corporation c:\winnt\system32\rassapi.dll
adsnt.dll   5.00.2195.1600 194.27 KB (198,928 bytes) 7/26/2000
7:00:00 AM Microsoft Corporation c:\winnt\system32\adsnt.dll
dbghelp.dll 5.00.2195.1 159.27 KB (163,088 bytes) 7/26/2000 7:00:00
AM Microsoft Corporation c:\winnt\system32\dbghelp.dll
localsec.dll 5.00.2195.1340 227.27 KB (232,720 bytes)
7/26/2000 7:00:00 AM Microsoft Corporation
c:\winnt\system32\localsec.dll
devmgr.dll  5.00.2166.1 215.77 KB (220,944 bytes) 7/26/2000 7:00:00
AM Microsoft Corporation c:\winnt\system32\devmgr.dll
filemgmt.dll 5.00.2134.1 287.27 KB (294,160 bytes) 7/26/2000
7:00:00 AM Microsoft Corporation c:\winnt\system32\filemgmt.dll
pdh.dll     5.00.2195.1600 143.27 KB (146,704 bytes) 7/26/2000
7:00:00 AM Microsoft Corporation c:\winnt\system32\pdh.dll
smlogcfg.dll 5.00.2163.1 273.27 KB (279,824 bytes) 7/26/2000
7:00:00 AM Microsoft Corporation c:\winnt\system32\smlogcfg.dll
cabinet.dll 5.00.2147.1 54.77 KB (56,080 bytes) 7/26/2000 7:00:00 AM
Microsoft Corporation c:\winnt\system32\cabinet.dll
```

Appendix C – Tunable Parameters

msinfo32.dll 5.00.2177.1 312.27 KB (319,760 bytes) 3/29/2002
12:38:52 PM Microsoft Corporation c:\program files\common
files\microsoft shared\msinfo\msinfo32.dll
riched20.dll 5.30.23.1203 421.27 KB (431,376 bytes)
7/26/2000 7:00:00 AM Microsoft Corporation
c:\winnt\system32\riched20.dll
riched32.dll 5.00.2134.1 3.77 KB (3,856 bytes) 7/26/2000 7:00:00
AM Microsoft Corporation c:\winnt\system32\riched32.dll
els.dll 5.00.2175.1 151.27 KB (154,896 bytes) 7/26/2000 7:00:00
AM Microsoft Corporation c:\winnt\system32\els.dll
ntmsmgr.dll 1,0,0,1 427.77 KB (438,032 bytes) 7/26/2000 7:00:00
AM Microsoft Corporation and HighGround Systems, Inc.
c:\winnt\system32\ntmsmgr.dll
mmfutil.dll 1.50.1085.0000 32.06 KB (32,829 bytes) 7/26/2000 7:00:00
AM Microsoft Corporation c:\winnt\system32\mmfutil.dll
logdrive.dll 1.50.1085.0000 200.06 KB (204,863 bytes)
7/26/2000 7:00:00 AM Microsoft Corporation
c:\winnt\system32\logdrive.dll
dfrgres.dll 5.00.2150.1 27.50 KB (28,160 bytes) 7/26/2000 7:00:00 AM
Executive Software International, Inc.
c:\winnt\system32\dfrgres.dll
dfrgsnap.dll 5.00.2195.31 41.77 KB (42,768 bytes) 7/26/2000
7:00:00 AM Executive Software International, Inc.
c:\winnt\system32\dfrgsnap.dll
dmdskres.dll 2191.1.296.2 119.00 KB (121,856 bytes)
7/26/2000 7:00:00 AM Microsoft Corp., VERITAS Software
c:\winnt\system32\dmdskres.dll
dmutil.dll 2195.23.297.2 42.27 KB (43,280 bytes) 7/26/2000 7:00:00
AM VERITAS Software Corp. c:\winnt\system32\dmutil.dll
ntmsapi.dll 5.00.1948.1 50.27 KB (51,472 bytes) 7/26/2000 7:00:00 AM
Microsoft Corporation c:\winnt\system32\ntmsapi.dll
dmdskmgr.dll 2195.1600.297.3 160.27 KB (164,112 bytes)
7/26/2000 7:00:00 AM Microsoft Corp., VERITAS Software
c:\winnt\system32\dmdskmgr.dll
mycomput.dll 5.00.2134.1 107.77 KB (110,352 bytes) 7/26/2000
7:00:00 AM Microsoft Corporation c:\winnt\system32\mycomput.dll
mmcndmgr.dll 5.00.2178.1 815.27 KB (834,832 bytes) 7/26/2000
7:00:00 AM Microsoft Corporation c:\winnt\system32\mmcndmgr.dll
mfc42u.dll 6.00.8665.0 972.05 KB (995,384 bytes) 7/26/2000 7:00:00
AM Microsoft Corporation c:\winnt\system32\mfc42u.dll
mmc.exe 5.00.2153.1 589.27 KB (603,408 bytes) 7/26/2000 7:00:00
AM Microsoft Corporation c:\winnt\system32\mmc.exe
sh.exe 5.2 build 64 271.50 KB (278,016 bytes) 3/29/2002
1:25:12 PM Mortice Kern Systems Inc. c:\mksnt\sh.exe
tapisrv.dll 5.00.2186.1 168.77 KB (172,816 bytes) 7/26/2000 7:00:00
AM Microsoft Corporation c:\winnt\system32\tapisrv.dll
mydocs.dll 5.00.2920.0000 55.77 KB (57,104 bytes) 7/26/2000 7:00:00
AM Microsoft Corporation c:\winnt\system32\mydocs.dll
wininet.dll 5.00.3103.1000 456.77 KB (467,728 bytes) 7/26/2000
7:00:00 AM Microsoft Corporation c:\winnt\system32\wininet.dll
shdoclc.dll 5.00.3103.1000 324.50 KB (332,288 bytes) 7/26/2000
7:00:00 AM Microsoft Corporation c:\winnt\system32\shdoclc.dll
actxprxy.dll 5.00.3103.800 70.27 KB (71,952 bytes) 7/26/2000
7:00:00 AM Microsoft Corporation c:\winnt\system32\actxprxy.dll

Appendix C – Tunable Parameters

msi.dll 1.11.1314.0 1.72 MB (1,798,928 bytes) 7/26/2000 7:00:00 AM Microsoft Corporation c:\winnt\system32\msi.dll
urlmon.dll 5.00.3103.1000 440.77 KB (451,344 bytes) 7/26/2000 7:00:00 AM Microsoft Corporation c:\winnt\system32?urlmon.dll
faxshell.dll 5.00.2134.1 8.27 KB (8,464 bytes) 7/26/2000 7:00:00 AM Microsoft Corporation c:\winnt\system32\xfaxshell.dll
msacm32.dll 5.00.2134.1 65.27 KB (66,832 bytes) 7/26/2000 7:00:00 AM Microsoft Corporation c:\winnt\system32\msacm32.dll
avifil32.dll 5.00.2134.1 76.27 KB (78,096 bytes) 7/26/2000 7:00:00 AM Microsoft Corporation c:\winnt\system32\avifil32.dll
msvfw32.dll 5.00.2134.1 113.77 KB (116,496 bytes) 7/26/2000 7:00:00 AM Microsoft Corporation c:\winnt\system32\msvfw32.dll
docprop2.dll 5.00.2178.1 297.77 KB (304,912 bytes) 7/26/2000 7:00:00 AM Microsoft Corporation c:\winnt\system32\docprop2.dll
ntshrui.dll 5.00.2134.1 46.77 KB (47,888 bytes) 7/26/2000 7:00:00 AM Microsoft Corporation c:\winnt\system32\ntshrui.dll
linkinfo.dll 5.00.2134.1 15.77 KB (16,144 bytes) 7/26/2000 7:00:00 AM Microsoft Corporation c:\winnt\system32\linkinfo.dll
browselc.dll 5.00.3103.1000 34.50 KB (35,328 bytes) 7/26/2000 7:00:00 AM Microsoft Corporation c:\winnt\system32\browselc.dll
powrprof.dll 5.00.3103.1000 13.27 KB (13,584 bytes) 7/26/2000 7:00:00 AM Microsoft Corporation c:\winnt\system32\powrprof.dll
batmeter.dll 5.00.2920.0000 20.27 KB (20,752 bytes) 7/26/2000 7:00:00 AM Microsoft Corporation c:\winnt\system32\batmeter.dll
stobject.dll 5.00.2195.1387 79.27 KB (81,168 bytes) 7/26/2000 7:00:00 AM Microsoft Corporation c:\winnt\system32\stobject.dll
webcheck.dll 5.00.3103.1000 251.77 KB (257,808 bytes) 7/26/2000 7:00:00 AM Microsoft Corporation c:\winnt\system32\webcheck.dll
browseui.dll 5.00.3103.1000 788.77 KB (807,696 bytes) 7/26/2000 7:00:00 AM Microsoft Corporation c:\winnt\system32\browseui.dll
shdocvw.dll 5.00.3103.1000 1.05 MB (1,104,144 bytes) 7/26/2000 7:00:00 AM Microsoft Corporation c:\winnt\system32\shdocvw.dll
explorer.exe 5.00.3103.1000 237.27 KB (242,960 bytes) 7/26/2000 7:00:00 AM Microsoft Corporation c:\winnt\explorer.exe
tpcc_com_all.dll 1, 0, 0, 1 80.00 KB (81,920 bytes) 3/29/2002 1:34:10 PM c:\inetpub\wwwroot\tpcc_c~2.dll
dbnetlib.dll 2000.080.0194.00 84.06 KB (86,082 bytes) 3/29/2002 1:07:13 PM Microsoft Corporation c:\winnt\system32\dbnetlib.dll
ntwdblib.dll 2000.080.0194.00 268.06 KB (274,489 bytes) 3/29/2002 1:07:29 PM Microsoft Corporation c:\winnt\system32\ntwdblib.dll
tpcc_dblib.dll Not Available 28.00 KB (28,672 bytes) 3/29/2002 1:34:08 PM Not Available c:\inetpub\wwwroot\tpcc_dblib.dll
tpcc_com.dll Not Available 24.00 KB (24,576 bytes) 3/29/2002 1:34:09 PM Not Available c:\inetpub\wwwroot\tpcc_com.dll
tpcc.dll 0, 4, 0, 0 92.00 KB (94,208 bytes) 3/29/2002 1:34:08 PM Microsoft Corporation c:\inetpub\wwwroot\tpcc.dll
iwrps.dll 5.00.2182.1 8.77 KB (8,976 bytes) 3/29/2002 6:39:35 AM Microsoft Corporation c:\winnt\system32\inetsrv\iwrps.dll
wamps.dll 5.00.2159.1 7.27 KB (7,440 bytes) 3/29/2002 6:39:35 AM Microsoft Corporation c:\winnt\system32\inetsrv\wamps.dll

Appendix C – Tunable Parameters

```
wshom.ocx 5.1.0.4615 72.05 KB (73,776 bytes) 7/26/2000 7:00:00 AM
Microsoft Corporation c:\winnt\system32\wshom.ocx
wamregps.dll 5.00.2159.1 7.27 KB (7,440 bytes) 3/29/2002 6:39:34
AM Microsoft Corporation c:\winnt\system32\wamregps.dll
scrrun.dll 5.1.0.5010 144.05 KB (147,512 bytes) 7/26/2000 7:00:00
AM Microsoft Corporation c:\winnt\system32\scrrun.dll
iisext.dll 5.00.2195.1613 41.77 KB (42,768 bytes) 3/29/2002 6:39:29
AM Microsoft Corporation c:\winnt\system32\iisext.dll
adsii.dll 5.00.2195.1613 238.77 KB (244,496 bytes) 3/29/2002
6:39:29 AM Microsoft Corporation c:\winnt\system32\adsii.dll
vbscript.dll 5.1.0.5010 428.06 KB (438,330 bytes) 7/26/2000
7:00:00 AM Microsoft Corporation c:\winnt\system32\vbscript.dll
asptxn.dll 5.00.0954 29.77 KB (30,480 bytes) 3/29/2002 6:39:31 AM
Microsoft Corporation c:\winnt\system32\inetsrv\asptxn.dll
asp.dll 5.00.0984 322.27 KB (330,000 bytes) 3/29/2002 6:39:31
AM Microsoft Corporation c:\winnt\system32\inetsrv\asp.dll
mfc42.dll 6.00.8665.0 972.05 KB (995,383 bytes) 7/26/2000 7:00:00
AM Microsoft Corporation c:\winnt\system32\mfc42.dll
wam.dll 5.00.0984 70.77 KB (72,464 bytes) 3/29/2002 6:39:33 AM
Microsoft Corporation c:\winnt\system32\inetsrv\wam.dll
odbcint.dll 3.520.6526.0 88.00 KB (90,112 bytes) 3/29/2002 1:07:09
PM Microsoft Corporation c:\winnt\system32\odbcint.dll
odbc32.dll 3.520.6526.0 216.27 KB (221,456 bytes) 3/29/2002
1:07:08 PM Microsoft Corporation c:\winnt\system32\odbc32.dll
comsvcs.dll 2000.2.3449.0 1.22 MB (1,277,712 bytes) 3/29/2002
6:39:25 AM Microsoft Corporation c:\winnt\system32\comsvcs.dll
iislog.dll 5.00.0984 75.77 KB (77,584 bytes) 3/29/2002 6:39:28 AM
Microsoft Corporation c:\winnt\system32\inetsrv\iislog.dll
httpext.dll 0.9.3940.2 418.27 KB (428,304 bytes) 3/29/2002 6:39:28
AM Microsoft Corporation c:\winnt\system32\inetsrv\httpext.dll
fpexedll.dll 4.0.2.4022 20.06 KB (20,541 bytes) 3/29/2002 6:39:24
AM Microsoft Corporation c:\program files\common files\microsoft
shared\web server extensions\40\bin\fpexedll.dll
md5filt.dll 5.00.0984 32.77 KB (33,552 bytes) 3/29/2002 6:39:32 AM
Microsoft Corporation c:\winnt\system32\inetsrv\md5filt.dll
gzip.dll 5.00.0984 30.27 KB (30,992 bytes) 3/29/2002 6:39:32 AM
Microsoft Corporation c:\winnt\system32\inetsrv\gzip.dll
compfilt.dll 5.00.0984 22.27 KB (22,800 bytes) 3/29/2002 6:39:31
AM Microsoft Corporation c:\winnt\system32\inetsrv\compfilt.dll
sspifilt.dll 5.00.0984 43.27 KB (44,304 bytes) 3/29/2002 6:39:32
AM Microsoft Corporation c:\winnt\system32\inetsrv\sspifilt.dll
iscomlog.dll 5.00.0984 24.77 KB (25,360 bytes) 3/29/2002 6:39:28
AM Microsoft Corporation c:\winnt\system32\inetsrv\iscomlog.dll
lonsint.dll 5.00.0984 11.77 KB (12,048 bytes) 3/29/2002 6:39:29 AM
Microsoft Corporation c:\winnt\system32\inetsrv\lonsint.dll
inetsloc.dll 5.00.0984 20.27 KB (20,752 bytes) 3/29/2002 6:39:29
AM Microsoft Corporation c:\winnt\system32\inetsloc.dll
iisfecnv.dll 5.00.0984 7.27 KB (7,440 bytes) 3/29/2002 6:39:34
AM Microsoft Corporation c:\winnt\system32\inetsrv\iisfecnv.dll
isatq.dll 5.00.0984 60.27 KB (61,712 bytes) 3/29/2002 6:39:30 AM
Microsoft Corporation c:\winnt\system32\inetsrv\isatq.dll
infocomm.dll 5.00.0984 229.77 KB (235,280 bytes) 3/29/2002
6:39:28 AM Microsoft Corporation
c:\winnt\system32\inetsrv\infocomm.dll
```

Appendix C – Tunable Parameters

w3svc.dll 5.00.0984 342.77 KB (350,992 bytes) 3/29/2002 6:39:33 AM Microsoft Corporation c:\winnt\system32\inetsrv\w3svc.dll
security.dll 5.00.2154.1 5.77 KB (5,904 bytes) 7/26/2000 7:00:00 AM Microsoft Corporation c:\winnt\system32\security.dll
svcext.dll 5.00.0984 39.77 KB (40,720 bytes) 3/29/2002 6:39:29 AM Microsoft Corporation c:\winnt\system32\inetsrv\svcext.dll
admexs.dll 5.00.0984 27.77 KB (28,432 bytes) 3/29/2002 6:39:28 AM Microsoft Corporation c:\winnt\system32\inetsrv\admexs.dll
wamreg.dll 5.00.0984 45.77 KB (46,864 bytes) 3/29/2002 6:39:33 AM Microsoft Corporation c:\winnt\system32\inetsrv\wamreg.dll
metadata.dll 5.00.0984 68.27 KB (69,904 bytes) 3/29/2002 6:39:29 AM Microsoft Corporation c:\winnt\system32\inetsrv\metadata.dll
iismap.dll 5.00.0984 55.77 KB (57,104 bytes) 3/29/2002 6:39:29 AM Microsoft Corporation c:\winnt\system32\iismap.dll
nsepm.dll 5.00.0984 43.27 KB (44,304 bytes) 3/29/2002 6:39:29 AM Microsoft Corporation c:\winnt\system32\inetsrv\nsepm.dll
admwprox.dll 5.00.0984 31.77 KB (32,528 bytes) 3/29/2002 6:39:34 AM Microsoft Corporation c:\winnt\system32\admwprox.dll
coadmin.dll 5.00.0984 39.27 KB (40,208 bytes) 3/29/2002 6:39:30 AM Microsoft Corporation c:\winnt\system32\inetsrv\coadmin.dll
iisadmin.dll 5.00.0984 15.27 KB (15,632 bytes) 3/29/2002 6:39:28 AM Microsoft Corporation c:\winnt\system32\inetsrv\iisadmin.dll
rpcref.dll 5.00.0984 4.27 KB (4,368 bytes) 3/29/2002 6:39:29 AM Microsoft Corporation c:\winnt\system32\inetsrv\rpcref.dll
iisrtl.dll 5.00.0984 120.27 KB (123,152 bytes) 3/29/2002 6:39:29 AM Microsoft Corporation c:\winnt\system32\iisrtl.dll
inetinfo.exe 5.00.0984 14.27 KB (14,608 bytes) 3/29/2002 6:39:28 AM Microsoft Corporation c:\winnt\system32\inetsrv\inetinfo.exe
wshnetbs.dll 5.00.2134.1 7.77 KB (7,952 bytes) 7/26/2000 7:00:00 AM Microsoft Corporation c:\winnt\system32\wshnetbs.dll
rapilib.dll 5.00.2167.1 25.27 KB (25,872 bytes) 7/26/2000 7:00:00 AM Microsoft Corporation c:\winnt\system32\rapilib.dll
rsvpsp.dll 5.00.2167.1 74.77 KB (76,560 bytes) 7/26/2000 7:00:00 AM Microsoft Corporation c:\winnt\system32\rsvpsp.dll
ntmarta.dll 5.00.2158.1 98.77 KB (101,136 bytes) 7/26/2000 7:00:00 AM Microsoft Corporation c:\winnt\system32\ntmarta.dll
provthrd.dll 1.50.1085.0000 68.07 KB (69,708 bytes) 3/29/2002 12:38:49 PM Microsoft Corporation c:\winnt\system32\wbem\provthrd.dll
ntevt.dll 1.50.1085.0000 192.06 KB (196,669 bytes) 7/26/2000 7:00:00 AM Microsoft Corporation c:\winnt\system32\wbem\ntevt.dll
perfos.dll 5.00.2155.1 21.27 KB (21,776 bytes) 7/26/2000 7:00:00 AM Microsoft Corporation c:\winnt\system32\perfos.dll
psapi.dll 5.00.2134.1 28.27 KB (28,944 bytes) 7/26/2000 7:00:00 AM Microsoft Corporation c:\winnt\system32\psapi.dll
framedyn.dll 1.50.1085.0000 164.05 KB (167,992 bytes) 7/26/2000 7:00:00 AM Microsoft Corporation c:\winnt\system32\wbem\framedyn.dll
cimwin32.dll 1.50.1085.0016 1.02 MB (1,073,232 bytes) 7/26/2000 7:00:00 AM Microsoft Corporation c:\winnt\system32\wbem\cimwin32.dll
wbemsvc.dll 1.50.1085.0007 40.07 KB (41,036 bytes) 7/26/2000 7:00:00 AM Microsoft Corporation c:\winnt\system32\wbem\wbemsvc.dll
wbemess.dll 1.50.1085.0007 364.07 KB (372,804 bytes) 7/26/2000 7:00:00 AM Microsoft Corporation c:\winnt\system32\wbem\wbemess.dll

Appendix C – Tunable Parameters

fastprox.dll 1.50.1085.0007 144.08 KB (147,536 bytes)
7/26/2000 7:00:00 AM Microsoft Corporation
c:\winnt\system32\wbem\fastprox.dll

wbemcore.dll 1.50.1085.0008 628.07 KB (643,140 bytes)
7/26/2000 7:00:00 AM Microsoft Corporation
c:\winnt\system32\wbem\wbemcore.dll

wbemcomn.dll 1.50.1085.0007 692.07 KB (708,675 bytes)
7/26/2000 7:00:00 AM Microsoft Corporation
c:\winnt\system32\wbem\wbemcomn.dll

winmgmt.exe 1.50.1085.0009 192.08 KB (196,685 bytes) 7/26/2000
7:00:00 AM Microsoft Corporation c:\winnt\system32\wbem\winmgmt.exe

msidle.dll 5.00.2920.0000 6.27 KB (6,416 bytes) 7/26/2000 7:00:00
AM Microsoft Corporation c:\winnt\system32\msidle.dll

mstask.exe 4.71.2137.1 115.27 KB (118,032 bytes) 3/29/2002
12:38:49 PM Microsoft Corporation c:\winnt\system32\mstask.exe

regsvc.exe 5.00.2195.31 65.27 KB (66,832 bytes) 7/26/2000 7:00:00
AM Microsoft Corporation c:\winnt\system32\regsvc.exe

rasdlg.dll 5.00.2194.1 514.27 KB (526,608 bytes) 7/26/2000 7:00:00
AM Microsoft Corporation c:\winnt\system32\rasdlg.dll

netcfgx.dll 5.00.2195.1618 533.77 KB (546,576 bytes) 7/26/2000
7:00:00 AM Microsoft Corporation c:\winnt\system32\netcfgx.dll

rasmans.dll 5.00.2195.27 146.77 KB (150,288 bytes) 7/26/2000
7:00:00 AM Microsoft Corporation c:\winnt\system32\rasmans.dll

wmi.dll 5.00.2191.1 6.27 KB (6,416 bytes) 7/26/2000 7:00:00 AM
Microsoft Corporation c:\winnt\system32\wmi.dll

netshell.dll 5.00.2195.1600 456.77 KB (467,728 bytes)
7/26/2000 7:00:00 AM Microsoft Corporation
c:\winnt\system32\netshell.dll

netman.dll 5.00.2195.1600 89.27 KB (91,408 bytes) 7/26/2000 7:00:00
AM Microsoft Corporation c:\winnt\system32\netman.dll

sens.dll 5.00.2163.1 36.77 KB (37,648 bytes) 7/26/2000 7:00:00 AM
Microsoft Corporation c:\winnt\system32\sens.dll

es.dll 1999.9.3422.21 231.77 KB (237,328 bytes) 7/26/2000
7:00:00 AM Microsoft Corporation c:\winnt\system32\es.dll

mtxoci.dll 1999.9.3421.3 109.27 KB (111,888 bytes) 3/29/2002
6:39:39 AM Microsoft Corporation c:\winnt\system32\mtxoci.dll

resutils.dll 5.00.2195.1613 39.77 KB (40,720 bytes) 7/26/2000
7:00:00 AM Microsoft Corporation c:\winnt\system32\resutils.dll

clusapi.dll 5.00.2195.1613 54.27 KB (55,568 bytes) 7/26/2000 7:00:00
AM Microsoft Corporation c:\winnt\system32\clusapi.dll

msvcp50.dll 5.00.7051 552.50 KB (565,760 bytes) 7/26/2000 7:00:00
AM Microsoft Corporation c:\winnt\system32\msvcp50.dll

xolehlp.dll 1999.9.3421.3 17.27 KB (17,680 bytes) 3/29/2002 6:39:39
AM Microsoft Corporation c:\winnt\system32\xolehlp.dll

msdtclog.dll 1999.9.3421.3 89.77 KB (91,920 bytes) 3/29/2002
6:39:39 AM Microsoft Corporation c:\winnt\system32\msdtclog.dll

mtxclu.dll 1999.9.3421.3 50.27 KB (51,472 bytes) 7/26/2000 7:00:00
AM Microsoft Corporation c:\winnt\system32\mtxclu.dll

msdtcprx.dll 2000.2.3449.0 625.77 KB (640,784 bytes)
3/29/2002 6:39:27 AM Microsoft Corporation
c:\winnt\system32\msdtcprx.dll

txfaux.dll 1999.9.3422.24 341.27 KB (349,456 bytes) 3/29/2002
6:39:39 AM Microsoft Corporation c:\winnt\system32\txfaux.dll

msdtctm.dll 2000.2.3449.0 1.07 MB (1,120,528 bytes) 3/29/2002
6:39:26 AM Microsoft Corporation c:\winnt\system32\msdtctm.dll

Appendix C – Tunable Parameters

msdtc.exe	1999.9.3421.3	6.77 KB (6,928 bytes)	3/29/2002 6:39:39 AM
Microsoft Corporation		c:\winnt\system32\msdtc.exe	
rasadhlp.dll	5.00.2168.1	7.27 KB (7,440 bytes)	7/26/2000 7:00:00 AM
Microsoft Corporation		c:\winnt\system32\rasadhlp.dll	
winrnr.dll	5.00.2160.1	18.77 KB (19,216 bytes)	7/26/2000 7:00:00 AM
Microsoft Corporation		c:\winnt\system32\winrnr.dll	
rnr20.dll	5.00.2195.1207	35.77 KB (36,624 bytes)	7/26/2000 7:00:00 AM
Microsoft Corporation		c:\winnt\system32\rnr20.dll	
wshtcpip.dll	5.00.2134.1	17.27 KB (17,680 bytes)	7/26/2000 7:00:00 AM
Microsoft Corporation		c:\winnt\system32\wshtcpip.dll	
dhcpcsvc.dll	5.00.2153.1	88.77 KB (90,896 bytes)	7/26/2000 7:00:00 AM
Microsoft Corporation		c:\winnt\system32\dhcpcsvc.dll	
tapi32.dll	5.00.2182.1	123.27 KB (126,224 bytes)	7/26/2000 7:00:00 AM
Microsoft Corporation		c:\winnt\system32\tapi32.dll	
rasman.dll	5.00.2188.1	54.77 KB (56,080 bytes)	7/26/2000 7:00:00 AM
Microsoft Corporation		c:\winnt\system32\rasman.dll	
rasapi32.dll	5.00.2188.1	189.77 KB (194,320 bytes)	7/26/2000 7:00:00 AM
Microsoft Corporation		c:\winnt\system32\rasapi32.dll	
iphlpapi.dll	5.00.2173.2	67.77 KB (69,392 bytes)	7/26/2000 7:00:00 AM
Microsoft Corporation		c:\winnt\system32\iphlpapi.dll	
msafd.dll	5.00.2195.1614	102.77 KB (105,232 bytes)	7/26/2000 7:00:00 AM
Microsoft Corporation		c:\winnt\system32\msafd.dll	
rpcss.dll	5.00.2195.1600	229.27 KB (234,768 bytes)	7/26/2000 7:00:00 AM
Microsoft Corporation		c:\winnt\system32\rpcss.dll	
svchost.exe	5.00.2134.1	7.77 KB (7,952 bytes)	7/26/2000 7:00:00 AM
Microsoft Corporation		c:\winnt\system32\svchost.exe	
iissuba.dll	5.00.0984	9.77 KB (10,000 bytes)	7/26/2000 7:00:00 AM
Microsoft Corporation		c:\winnt\system32\iissuba.dll	
scecli.dll	5.00.2191.1	105.27 KB (107,792 bytes)	7/26/2000 7:00:00 AM
Microsoft Corporation		c:\winnt\system32\scecli.dll	
atl.dll	3.00.8449	57.56 KB (58,938 bytes)	7/26/2000 7:00:00 AM
Microsoft Corporation		c:\winnt\system32\atl.dll	
certcli.dll	5.00.2175.1	132.27 KB (135,440 bytes)	7/26/2000 7:00:00 AM
Microsoft Corporation		c:\winnt\system32\certcli.dll	
esent.dll	6.0.3940.4	1.08 MB (1,135,888 bytes)	7/26/2000 7:00:00 AM
Microsoft Corporation		c:\winnt\system32\esent.dll	
mswsock.dll	5.00.2195.1207	62.77 KB (64,272 bytes)	7/26/2000 7:00:00 AM
Microsoft Corporation		c:\winnt\system32\mswsock.dll	
ntdsatq.dll	5.00.2195.1284	31.27 KB (32,016 bytes)	7/26/2000 7:00:00 AM
Microsoft Corporation		c:\winnt\system32\ntdsatq.dll	
ntdsa.dll	5.00.2195.1600	987.27 KB (1,010,960 bytes)	7/26/2000 7:00:00 AM
Microsoft Corporation		c:\winnt\system32\ntdsa.dll	
kdcsvc.dll	5.00.2195.1284	133.77 KB (136,976 bytes)	7/26/2000 7:00:00 AM
Microsoft Corporation		c:\winnt\system32\kdcsvc.dll	
sfmapi.dll	5.00.2134.1	38.77 KB (39,696 bytes)	7/26/2000 7:00:00 AM
Microsoft Corporation		c:\winnt\system32\sfmapi.dll	
rtutils.dll	5.00.2168.1	43.77 KB (44,816 bytes)	7/26/2000 7:00:00 AM
Microsoft Corporation		c:\winnt\system32\rtutils.dll	
adslrpc.dll	5.00.2195.1600	125.77 KB (128,784 bytes)	7/26/2000 7:00:00 AM
Microsoft Corporation		c:\winnt\system32\adslrpc.dll	
activeds.dll	5.00.2172.1	172.77 KB (176,912 bytes)	7/26/2000 7:00:00 AM
Microsoft Corporation		c:\winnt\system32\activeds.dll	
mprapi.dll	5.00.2181.1	79.27 KB (81,168 bytes)	7/26/2000 7:00:00 AM
Microsoft Corporation		c:\winnt\system32\mprapi.dll	

Appendix C – Tunable Parameters

rassfm.dll 5.00.2195.1179 21.27 KB (21,776 bytes) 7/26/2000 7:00:00 AM Microsoft Corporation c:\winnt\system32\rassfm.dll
schannel.dll 5.00.2195.1163 137.27 KB (140,560 bytes) 7/26/2000 7:00:00 AM Microsoft Corporation c:\winnt\system32\schannel.dll
netlogon.dll 5.00.2195.1600 348.27 KB (356,624 bytes) 7/26/2000 7:00:00 AM Microsoft Corporation c:\winnt\system32\netlogon.dll
msv1_0.dll 5.00.2195.1620 92.77 KB (94,992 bytes) 7/26/2000 7:00:00 AM Microsoft Corporation c:\winnt\system32\msv1_0.dll
kerberos.dll 5.00.2195.1378 197.77 KB (202,512 bytes) 7/26/2000 7:00:00 AM Microsoft Corporation c:\winnt\system32\kerberos.dll
msprivs.dll 5.00.2154.1 41.50 KB (42,496 bytes) 7/26/2000 7:00:00 AM Microsoft Corporation c:\winnt\system32\msprivs.dll
samsrv.dll 5.00.2195.1609 343.27 KB (351,504 bytes) 7/26/2000 7:00:00 AM Microsoft Corporation c:\winnt\system32\samsrv.dll
lsasrv.dll 5.00.2195.1620 475.27 KB (486,672 bytes) 7/26/2000 7:00:00 AM Microsoft Corporation c:\winnt\system32\lsasrv.dll
lsass.exe 5.00.2195.1620 32.77 KB (33,552 bytes) 7/26/2000 7:00:00 AM Microsoft Corporation c:\winnt\system32\lsass.exe
wmicore.dll 5.00.2178.1 70.77 KB (72,464 bytes) 7/26/2000 7:00:00 AM Microsoft Corporation c:\winnt\system32\wmicore.dll
xactsrv.dll 5.00.2134.1 90.27 KB (92,432 bytes) 7/26/2000 7:00:00 AM Microsoft Corporation c:\winnt\system32\xactsrv.dll
ntlsapi.dll 5.00.2134.1 6.77 KB (6,928 bytes) 7/26/2000 7:00:00 AM Microsoft Corporation c:\winnt\system32\ntlsapi.dll
browser.dll 5.00.2142.1 48.27 KB (49,424 bytes) 7/26/2000 7:00:00 AM Microsoft Corporation c:\winnt\system32\browser.dll
seclogon.dll 5.00.2135.1 15.77 KB (16,144 bytes) 7/26/2000 7:00:00 AM Microsoft Corporation c:\winnt\system32\seclogon.dll
psbase.dll 5.00.2195.1600 111.77 KB (114,448 bytes) 7/26/2000 7:00:00 AM Microsoft Corporation c:\winnt\system32\psbase.dll
cryptsvc.dll 5.00.2181.1 61.77 KB (63,248 bytes) 7/26/2000 7:00:00 AM Microsoft Corporation c:\winnt\system32\cryptsvc.dll
cryptdll.dll 5.00.2135.1 41.27 KB (42,256 bytes) 7/26/2000 7:00:00 AM Microsoft Corporation c:\winnt\system32\cryptdll.dll
wkssvc.dll 5.00.2195.1175 95.27 KB (97,552 bytes) 7/26/2000 7:00:00 AM Microsoft Corporation c:\winnt\system32\wkssvc.dll
srvsvc.dll 5.00.2178.1 79.27 KB (81,168 bytes) 7/26/2000 7:00:00 AM Microsoft Corporation c:\winnt\system32\srvsvc.dll
cfgmgr32.dll 5.00.2134.1 16.77 KB (17,168 bytes) 7/26/2000 7:00:00 AM Microsoft Corporation c:\winnt\system32\cfgmgr32.dll
dmserver.dll 2195.23.297.2 11.77 KB (12,048 bytes) 7/26/2000 7:00:00 AM VERITAS Software Corp. c:\winnt\system32\dmserver.dll
winsta.dll 5.00.2195.32 36.27 KB (37,136 bytes) 7/26/2000 7:00:00 AM Microsoft Corporation c:\winnt\system32\winsta.dll
icmp.dll 5.00.2134.1 7.27 KB (7,440 bytes) 7/26/2000 7:00:00 AM Microsoft Corporation c:\winnt\system32\icmp.dll
lmhsvc.dll 5.00.2134.1 9.27 KB (9,488 bytes) 7/26/2000 7:00:00 AM Microsoft Corporation c:\winnt\system32\lmhsvc.dll
eventlog.dll 5.00.2178.1 43.77 KB (44,816 bytes) 7/26/2000 7:00:00 AM Microsoft Corporation c:\winnt\system32\eventlog.dll
ntdsapi.dll 5.00.2160.1 56.27 KB (57,616 bytes) 7/26/2000 7:00:00 AM Microsoft Corporation c:\winnt\system32\ntdsapi.dll

Appendix C – Tunable Parameters

scesrv.dll 5.00.2188.1 225.77 KB (231,184 bytes) 7/26/2000 7:00:00 AM Microsoft Corporation c:\winnt\system32\scesrv.dll
umpnpgmgr.dll 5.00.2182.1 86.27 KB (88,336 bytes) 7/26/2000 7:00:00 AM Microsoft Corporation c:\winnt\system32\umpnpgmgr.dll
services.exe 5.00.2134.1 86.77 KB (88,848 bytes) 7/26/2000 7:00:00 AM Microsoft Corporation c:\winnt\system32\services.exe
clbcatq.dll 2000.2.3449.0 496.27 KB (508,176 bytes) 3/29/2002 6:39:25 AM Microsoft Corporation c:\winnt\system32\clbcatq.dll
oleaut32.dll 2.40.4514 600.27 KB (614,672 bytes) 7/26/2000 7:00:00 AM Microsoft Corporation c:\winnt\system32\oleaut32.dll
netmsg.dll 5.00.2137.1 152.50 KB (156,160 bytes) 7/26/2000 7:00:00 AM Microsoft Corporation c:\winnt\system32\netmsg.dll
comdlg32.dll 5.00.3103.1000 236.77 KB (242,448 bytes) 7/26/2000 7:00:00 AM Microsoft Corporation c:\winnt\system32\comdlg32.dll
netui2.dll 5.00.2134.1 280.27 KB (286,992 bytes) 7/26/2000 7:00:00 AM Microsoft Corporation c:\winnt\system32\netui2.dll
mprui.dll 5.00.2134.1 54.77 KB (56,080 bytes) 7/26/2000 7:00:00 AM Microsoft Corporation c:\winnt\system32\mprui.dll
netui1.dll 5.00.2134.1 210.27 KB (215,312 bytes) 7/26/2000 7:00:00 AM Microsoft Corporation c:\winnt\system32\netui1.dll
netui0.dll 5.00.2134.1 70.27 KB (71,952 bytes) 7/26/2000 7:00:00 AM Microsoft Corporation c:\winnt\system32\netui0.dll
ntlanman.dll 5.00.2157.1 35.27 KB (36,112 bytes) 7/26/2000 7:00:00 AM Microsoft Corporation c:\winnt\system32\ntlanman.dll
mpr.dll 5.00.2195.1340 53.27 KB (54,544 bytes) 7/26/2000 7:00:00 AM Microsoft Corporation c:\winnt\system32\mpr.dll
cscui.dll 5.00.2195.1387 227.27 KB (232,720 bytes) 7/26/2000 7:00:00 AM Microsoft Corporation c:\winnt\system32\cscui.dll
winspool.drv 5.00.2195.1340 109.77 KB (112,400 bytes) 7/26/2000 7:00:00 AM Microsoft Corporation c:\winnt\system32\winspool.drv
winscard.dll 5.00.2134.1 77.27 KB (79,120 bytes) 7/26/2000 7:00:00 AM Microsoft Corporation c:\winnt\system32\winscard.dll
wlnotify.dll 5.00.2195.1163 53.27 KB (54,544 bytes) 7/26/2000 7:00:00 AM Microsoft Corporation c:\winnt\system32\wlnotify.dll
cscdll.dll 5.00.2195.1600 98.27 KB (100,624 bytes) 7/26/2000 7:00:00 AM Microsoft Corporation c:\winnt\system32\cscdll.dll
lz32.dll 5.00.2134.1 9.77 KB (10,000 bytes) 7/26/2000 7:00:00 AM Microsoft Corporation c:\winnt\system32\lz32.dll
version.dll 5.00.2134.1 15.77 KB (16,144 bytes) 7/26/2000 7:00:00 AM Microsoft Corporation c:\winnt\system32\version.dll
rsabase.dll 5.00.2195.1391 129.27 KB (132,368 bytes) 7/26/2000 7:00:00 AM Microsoft Corporation c:\winnt\system32\rsabase.dll
mscat32.dll 5.131.2134.1 7.77 KB (7,952 bytes) 7/26/2000 7:00:00 AM Microsoft Corporation c:\winnt\system32\mscat32.dll
ole32.dll 5.00.2195.1607 965.27 KB (988,432 bytes) 7/26/2000 7:00:00 AM Microsoft Corporation c:\winnt\system32\ole32.dll
imagehlp.dll 5.00.2195.1 125.27 KB (128,272 bytes) 7/26/2000 7:00:00 AM Microsoft Corporation c:\winnt\system32\imagehlp.dll
msasn1.dll 5.00.2134.1 51.27 KB (52,496 bytes) 7/26/2000 7:00:00 AM Microsoft Corporation c:\winnt\system32\msasn1.dll
crypt32.dll 5.131.2195.1340 464.77 KB (475,920 bytes) 7/26/2000 7:00:00 AM Microsoft Corporation c:\winnt\system32\crypt32.dll

Appendix C – Tunable Parameters

wintrust.dll 5.131.2143.1 162.27 KB (166,160 bytes)
7/26/2000 7:00:00 AM Microsoft Corporation
c:\winnt\system32\wintrust.dll

setupapi.dll 5.00.2195.1608 552.77 KB (566,032 bytes)
7/26/2000 7:00:00 AM Microsoft Corporation
c:\winnt\system32\setupapi.dll

winmm.dll 5.00.2161.1 184.77 KB (189,200 bytes) 7/26/2000 7:00:00
AM Microsoft Corporation c:\winnt\system32\winmm.dll

comctl32.dll 5.81 537.77 KB (550,672 bytes) 7/26/2000 7:00:00
AM Microsoft Corporation c:\winnt\system32\comctl32.dll

shlwapi.dll 5.00.3103.1000 282.27 KB (289,040 bytes) 7/26/2000
7:00:00 AM Microsoft Corporation c:\winnt\system32\shlwapi.dll

shell32.dll 5.00.3103.1000 2.25 MB (2,358,032 bytes) 7/26/2000
7:00:00 AM Microsoft Corporation c:\winnt\system32\shell32.dll

msgina.dll 5.00.2195.1600 323.27 KB (331,024 bytes) 7/26/2000
7:00:00 AM Microsoft Corporation c:\winnt\system32\msgina.dll

wsock32.dll 5.00.2195.1207 21.27 KB (21,776 bytes) 7/26/2000 7:00:00
AM Microsoft Corporation c:\winnt\system32\wsock32.dll

dnsapi.dll 5.00.2195.1600 127.77 KB (130,832 bytes) 7/26/2000
7:00:00 AM Microsoft Corporation c:\winnt\system32\dnsapi.dll

wldap32.dll 5.00.2195.1175 155.27 KB (158,992 bytes) 7/26/2000
7:00:00 AM Microsoft Corporation c:\winnt\system32\wldap32.dll

ws2help.dll 5.00.2134.1 17.77 KB (18,192 bytes) 7/26/2000 7:00:00 AM
Microsoft Corporation c:\winnt\system32\ws2help.dll

ws2_32.dll 5.00.2195.1340 68.77 KB (70,416 bytes) 7/26/2000 7:00:00
AM Microsoft Corporation c:\winnt\system32\ws2_32.dll

samlib.dll 5.00.2160.1 46.27 KB (47,376 bytes) 7/26/2000 7:00:00 AM
Microsoft Corporation c:\winnt\system32\samlib.dll

netrap.dll 5.00.2134.1 11.27 KB (11,536 bytes) 7/26/2000 7:00:00 AM
Microsoft Corporation c:\winnt\system32\netrap.dll

netapi32.dll 5.00.2195.1600 303.27 KB (310,544 bytes)
7/26/2000 7:00:00 AM Microsoft Corporation
c:\winnt\system32\netapi32.dll

profmap.dll 5.00.2181.1 29.27 KB (29,968 bytes) 7/26/2000 7:00:00 AM
Microsoft Corporation c:\winnt\system32\profmap.dll

secur32.dll 5.00.2195.1600 47.27 KB (48,400 bytes) 7/26/2000 7:00:00
AM Microsoft Corporation c:\winnt\system32\secur32.dll

sfc.dll 5.00.2195.1618 90.05 KB (92,216 bytes) 7/26/2000 7:00:00
AM Microsoft Corporation c:\winnt\system32\sfc.dll

nddeapi.dll 5.00.2137.1 15.27 KB (15,632 bytes) 7/26/2000 7:00:00 AM
Microsoft Corporation c:\winnt\system32\nddeapi.dll

userenv.dll 5.00.2195.1600 359.27 KB (367,888 bytes) 7/26/2000
7:00:00 AM Microsoft Corporation c:\winnt\system32\userenv.dll

user32.dll 5.00.2195.1600 392.77 KB (402,192 bytes) 7/26/2000
7:00:00 AM Microsoft Corporation c:\winnt\system32\user32.dll

gdi32.dll 5.00.2195.1340 228.77 KB (234,256 bytes) 7/26/2000
7:00:00 AM Microsoft Corporation c:\winnt\system32\gdi32.dll

rpcrt4.dll 5.00.2195.1615 436.27 KB (446,736 bytes) 7/26/2000
7:00:00 AM Microsoft Corporation c:\winnt\system32\rpcrt4.dll

advapi32.dll 5.00.2195.1600 349.27 KB (357,648 bytes)
7/26/2000 7:00:00 AM Microsoft Corporation
c:\winnt\system32\advapi32.dll

kernel32.dll 5.00.2195.1600 713.27 KB (730,384 bytes)
7/26/2000 7:00:00 AM Microsoft Corporation
c:\winnt\system32\kernel32.dll

Appendix C – Tunable Parameters

```
msvcrt.dll 6.10.8637.0 288.09 KB (295,000 bytes) 7/26/2000 7:00:00
AM Microsoft Corporation c:\winnt\system32\msvcrt.dll
winlogon.exe 5.00.2195.1600 172.77 KB (176,912 bytes)
7/26/2000 7:00:00 AM Microsoft Corporation
c:\winnt\system32\winlogon.exe
sfcfiles.dll 5.00.2195.1 973.27 KB (996,624 bytes) 7/26/2000
7:00:00 AM Microsoft Corporation c:\winnt\system32\sfcfiles.dll
ntdll.dll 5.00.2195.1600 475.27 KB (486,672 bytes) 7/26/2000
7:00:00 AM Microsoft Corporation c:\winnt\system32\ntdll.dll
smss.exe 5.00.2195.31 44.27 KB (45,328 bytes) 7/26/2000 7:00:00
AM Microsoft Corporation c:\winnt\system32\smss.exe
```

[Services]

Display Name	Name	State	Start	Mode	Service Type	Path	Error
Control	Start Name	Tag	ID				
Alerter	Alerter	Stopped		Manual	Share Process		
	c:\winnt\system32\services.exe			Normal	LocalSystem	0	
Application Management Process	AppMgmt	Stopped		Manual	Share		
	c:\winnt\system32\services.exe			Normal	LocalSystem	0	
Computer Browser	Browser	Running		Auto	Share Process		
	c:\winnt\system32\services.exe			Normal	LocalSystem	0	
Indexing Service	cisvc	Stopped		Manual	Share Process		
	c:\winnt\system32\cisvc.exe			Normal	LocalSystem	0	
ClipBook	ClipSrv	Stopped		Manual	Own Process		
	c:\winnt\system32\clipsrv.exe			Normal	LocalSystem	0	
Distributed File System	Dfs	Stopped		Manual	Own Process		
	c:\winnt\system32\dfssvc.exe			Normal	LocalSystem	0	
DHCP Client	Dhcp	Stopped		Manual	Share Process		
	c:\winnt\system32\services.exe			Normal	LocalSystem	0	
Logical Disk Manager	Administrative Service	Stopped			dmadmin		
	Manual	Share Process			c:\winnt\system32\dmadmin.exe /com		
	Normal	LocalSystem			0		
Logical Disk Manager	dmserver	Running		Auto	Share Process		
	c:\winnt\system32\services.exe			Normal	LocalSystem	0	
DNS Client	Dnscache	Stopped		Manual	Share Process		
	c:\winnt\system32\services.exe			Normal	LocalSystem	0	
Event Log	Eventlog	Running		Auto	Share Process		
	c:\winnt\system32\services.exe			Normal	LocalSystem	0	
COM+ Event System	EventSystem	Running		Manual	Share Process		
	c:\winnt\system32\svchost.exe -k netsvcs			Normal	LocalSystem	0	
Fax Service	Fax	Stopped		Manual	Own Process		
	c:\winnt\system32\faxsvc.exe			Normal	LocalSystem	0	
IIS Admin Service	IISADMIN	Running		Auto	Share Process		
	c:\winnt\system32\inet_srv\inetinfo.exe			Normal	LocalSystem	0	
Intersite Messaging	IsmServ	Stopped			Disabled	Own Process	
	c:\winnt\system32\ismserv.exe			Normal	LocalSystem	0	
Kerberos Key Distribution Center Process	kdc	Stopped			Disabled	Share	
	c:\winnt\system32\lsass.exe			Normal	LocalSystem	0	
Server	lanmanserver	Running		Auto	Share Process		
	c:\winnt\system32\services.exe			Normal	LocalSystem	0	

Appendix C – Tunable Parameters

```

Workstation lanmanworkstation Running      Auto  Share Process
      c:\winnt\system32\services.exe      Normal  LocalSystem 0
License Logging Service LicenseService    Stopped Manual      Own
Process      c:\winnt\system32\llssrv.exe Normal  LocalSystem 0
TCP/IP NetBIOS Helper Service LmHosts     Running Auto  Share
Process      c:\winnt\system32\services.exe Normal  LocalSystem
0
Messenger Messenger Stopped      Manual  Share Process
      c:\winnt\system32\services.exe      Normal  LocalSystem 0
NetMeeting Remote Desktop Sharing mnmsrvc Stopped Manual
Own Process c:\winnt\system32\mnmsrvc.exe Normal  LocalSystem
0
Distributed Transaction Coordinator MSDTC Running      Auto  Own Process
      c:\winnt\system32\msdtc.exe Normal  LocalSystem 0
Windows Installer MSIServer Stopped      Manual  Share Process
      c:\winnt\system32\msiexec.exe /v Normal  LocalSystem 0
Network DDE NetDDE Stopped      Manual  Share Process
      c:\winnt\system32\netdde.exe Normal  LocalSystem 0
Network DDE DSDM NetDDEdsdm Stopped      Manual  Share Process
      c:\winnt\system32\netdde.exe Normal  LocalSystem 0
Net Logon Netlogon Stopped      Manual  Share Process
      c:\winnt\system32\lsass.exe Normal  LocalSystem 0
Network Connections Netman Running      Manual  Share
Process      c:\winnt\system32\svchost.exe -k netsvcs Normal
LocalSystem 0
File Replication NtFrs Stopped      Manual  Own Process
      c:\winnt\system32\ntfrs.exe Ignore  LocalSystem 0
NT LM Security Support Provider NtLmSsp Stopped Manual
Share Process c:\winnt\system32\lsass.exe Normal
LocalSystem 0
Removable Storage NtmsSvc Stopped      Manual  Share Process
      c:\winnt\system32\svchost.exe -k netsvcs Normal  LocalSystem
0
Plug and Play PlugPlay Running      Auto  Share Process
      c:\winnt\system32\services.exe Normal  LocalSystem 0
IPSEC Policy Agent PolicyAgent Stopped      Manual  Share
Process      c:\winnt\system32\lsass.exe Normal  LocalSystem 0
Protected Storage ProtectedStorage Running      Auto  Share Process
      c:\winnt\system32\services.exe Normal  LocalSystem 0
Remote Access Auto Connection Manager RasAuto Stopped
Manual      Share Process c:\winnt\system32\svchost.exe -k
netsvcs Normal  LocalSystem 0
Remote Access Connection Manager RasMan Stopped Manual
Share Process c:\winnt\system32\svchost.exe -k netsvcs
Normal  LocalSystem 0
Routing and Remote Access RemoteAccess Stopped Disabled
Share Process c:\winnt\system32\svchost.exe -k netsvcs
Normal  LocalSystem 0
Remote Registry Service RemoteRegistry Running      Auto  Own Process
      c:\winnt\system32\regsvc.exe Normal  LocalSystem 0
Remote Command Service RMSYS Stopped      Manual  Own Process
      c:\benchcrf\rsys.exe Normal  LocalSystem 0
Remote Procedure Call (RPC) Locator RpcLocator Stopped Manual
Own Process c:\winnt\system32\locator.exe Normal  LocalSystem
0

```

Appendix C – Tunable Parameters

```

Remote Procedure Call (RPC)  RpcSs Running      Auto  Share Process
    c:\winnt\system32\svchost -k rpcss Normal      LocalSystem 0
QoS RSVP      RSVP Running      Manual      Own Process
    c:\winnt\system32\rsvp.exe -s Normal      LocalSystem 0
Security Accounts Manager  SamSs Running      Auto  Share Process
    c:\winnt\system32\lsass.exe Normal      LocalSystem 0
Smart Card Helper SCardDrv  Stopped      Manual      Share Process
    c:\winnt\system32\scardsvr.exe Ignore      LocalSystem 0
Smart Card SCardSvr  Stopped      Manual      Share Process
    c:\winnt\system32\scardsvr.exe Ignore      LocalSystem 0
Task Scheduler  Schedule Running      Auto  Share Process
    c:\winnt\system32\mstask.exe Normal      LocalSystem 0
RunAs Service  seclogon Running      Auto  Share Process
    c:\winnt\system32\services.exe Ignore      LocalSystem 0
System Event Notification  SENS Running      Auto  Share Process
    c:\winnt\system32\svchost.exe -k netsvcs Normal      LocalSystem
    0
Internet Connection Sharing  SharedAccess  Stopped      Manual
Share Process      c:\winnt\system32\svchost.exe -k netsvcs
Normal      LocalSystem 0
Print Spooler  Spooler  Stopped      Manual      Own Process
    c:\winnt\system32\spoolsv.exe Normal      LocalSystem 0
Performance Logs and Alerts  SysmonLog  Stopped      Manual      Own
Process      c:\winnt\system32\smlogsvc.exe Normal      LocalSystem
    0
Telephony  TapiSrv  Running      Manual      Share Process
    c:\winnt\system32\svchost.exe -k tapisrv Normal      LocalSystem
    0
Terminal Services TermService Stopped      Disabled  Own Process
    c:\winnt\system32\termsrv.exe Normal      LocalSystem 0
Telnet      TlntSvr  Stopped      Manual      Own Process
    c:\winnt\system32\tlntsvr.exe Normal      LocalSystem 0
Distributed Link Tracking Server  TrkSvr  Stopped      Manual
Share Process      c:\winnt\system32\services.exe Normal
LocalSystem 0
Distributed Link Tracking Client  TrkWks  Stopped      Manual
Share Process      c:\winnt\system32\services.exe Normal
LocalSystem 0
Uninterruptible Power Supply  UPS  Stopped      Manual      Own Process
    c:\winnt\system32\ups.exe Normal      LocalSystem 0
Utility Manager  UtilMan  Stopped      Manual      Own Process
    c:\winnt\system32\utilman.exe Normal      LocalSystem 0
Windows Time      W32Time  Stopped      Manual      Share Process
    c:\winnt\system32\services.exe Normal      LocalSystem 0
World Wide Web Publishing Service  W3SVC Running      Auto  Share
Process      c:\winnt\system32\inetsrv\inetinfo.exe Normal
LocalSystem 0
Windows Management Instrumentation  WinMgmt  Running      Auto  Own
Process      c:\winnt\system32\wbem\winmgmt.exe Ignore      LocalSystem
    0
Windows Management Instrumentation Driver Extensions  Wmi  Running
Manual      Share Process      c:\winnt\system32\services.exe
Normal      LocalSystem 0

```

[Program Groups]

Appendix C – Tunable Parameters

Group Name	Name	User Name	
Accessories	Default User:Accessories	Default User	
Accessories\Accessibility	Default User:Accessories\Accessibility	Default User	
Accessories\Entertainment	Default User:Accessories\Entertainment	Default User	
Accessories\System Tools	Default User:Accessories\System Tools	Default User	
Startup	Default User:Startup	Default User	
Accessories	All Users:Accessories	All Users	
Accessories\Accessibility	All Users:Accessories\Accessibility	All Users	
Accessories\Communications	All Users:Accessories\Communications	All Users	
Accessories\Entertainment	All Users:Accessories\Entertainment	All Users	
Accessories\Games	All Users:Accessories\Games	All Users	
Accessories\System Tools	All Users:Accessories\System Tools	All Users	
Administrative Tools	All Users:Administrative Tools	All Users	
Microsoft SQL Server	All Users:Microsoft SQL Server	All Users	
MKS Toolkit	All Users:MKS Toolkit	All Users	
Startup	All Users:Startup	All Users	
Accessories	CLIENT1\Administrator:Accessories	CLIENT1\Administrator	
Accessories\Accessibility	CLIENT1\Administrator:Accessories\Accessibility	CLIENT1\Administrator	
Accessories\Entertainment	CLIENT1\Administrator:Accessories\Entertainment	CLIENT1\Administrator	
Accessories\System Tools	CLIENT1\Administrator:Accessories\System Tools	CLIENT1\Administrator	
Administrative Tools	CLIENT1\Administrator:Administrative Tools	CLIENT1\Administrator	
Startup	CLIENT1\Administrator:Startup	CLIENT1\Administrator	

[Startup Programs]

Program	Command	User Name	Location
No startup program information			

[OLE Registration]

Object	Local Server
Sound (OLE2)	sndrec32.exe
Media Clip	mplay32.exe
Video Clip	mplay32.exe /avi
MIDI Sequence	mplay32.exe /mid
Sound	Not Available
Media Clip	Not Available
Image Document	"C:\Program Files\Windows NT\Accessories\ImageVue\KodakImg.exe"
WordPad Document	"%ProgramFiles%\Windows NT\Accessories\WORDPAD.EXE"
Windows Media Services DRM Storage object	Not Available

Appendix C – Tunable Parameters

Bitmap Image mspaint.exe

[Internet Explorer 5]

[Following are sub-categories of this main category]

[Summary]

Item Value

Version 5.00.3103.1000
Build 53103.1000
Product ID 51876-OEM-0001501-00000
Application Path C:\Program Files\Internet Explorer
Language English (United States)
Active Printer Not Available

Cipher Strength 56-bit
Content Advisor Disabled
IEAK Install No

[File Versions]

File	Version	Size	Date	Path	Company
advapi32.dll	5.0.2195.1600	349 KB	7/26/2000 6:00:00 AM	C:\WINNT\system32	Microsoft Corporation
advapi32.dll	5.0.2195.1600	349 KB	7/26/2000 6:00:00 AM	.	Microsoft Corporation
advpack.dll	5.0.3103.1000	87 KB	7/26/2000 6:00:00 AM	C:\WINNT\system32	Microsoft Corporation
advpack.dll	5.0.3103.1000	87 KB	7/26/2000 6:00:00 AM	.	Microsoft Corporation
browseui.dll	5.0.3103.1000	789 KB	7/26/2000 6:00:00 AM	C:\WINNT\system32	Microsoft Corporation
browseui.dll	5.0.3103.1000	789 KB	7/26/2000 6:00:00 AM	.	Microsoft Corporation
ckcnv.exe	5.0.2189.1	9 KB	7/26/2000 6:00:00 AM	C:\WINNT\system32	Microsoft Corporation
ckcnv.exe	5.0.2189.1	9 KB	7/26/2000 6:00:00 AM	.	Microsoft Corporation
comctl32.dll	5.81.3103.1000	538 KB	7/26/2000 6:00:00 AM	C:\WINNT\system32	Microsoft Corporation
comctl32.dll	5.81.3103.1000	538 KB	7/26/2000 6:00:00 AM	.	Microsoft Corporation
crypt32.dll	5.131.2195.1340	465 KB	7/26/2000 6:00:00 AM	C:\WINNT\system32	Microsoft Corporation
crypt32.dll	5.131.2195.1340	465 KB	7/26/2000 6:00:00 AM	.	Microsoft Corporation
ehnsig.dll	<File Missing>	Not Available	Not Available	Not Available	Not Available
iemigrat.dll	<File Missing>	Not Available	Not Available	Not Available	Not Available

Appendix C – Tunable Parameters

iesetup.dll	5.0.3103.1000	57 KB	7/26/2000	6:00:00 AM	
	C:\WINNT\system32 Microsoft Corporation				
iesetup.dll	5.0.3103.1000	57 KB	7/26/2000	6:00:00 AM	.
	Microsoft Corporation				
iexplore.exe	5.0.2920.0	59 KB	7/26/2000	6:00:00 AM	C:\Program
	Files\Internet Explorer Microsoft Corporation				
imagehlp.dll	5.0.2195.1	125 KB	7/26/2000	6:00:00 AM	
	C:\WINNT\system32 Microsoft Corporation				
imagehlp.dll	5.0.2195.1	125 KB	7/26/2000	6:00:00 AM	.
	Microsoft Corporation				
imghelp.dll	<File Missing>	Not Available	Not Available	Not Available	Not
	Available Not Available				
inseng.dll	5.0.3103.1000	72 KB	7/26/2000	6:00:00 AM	
	C:\WINNT\system32 Microsoft Corporation				
inseng.dll	5.0.3103.1000	72 KB	7/26/2000	6:00:00 AM	.
	Microsoft Corporation				
jobexec.dll	5.0.0.1	47 KB	7/26/2000	6:00:00 AM	C:\WINNT\system32
	Microsoft Corporation				
jobexec.dll	5.0.0.1	47 KB	7/26/2000	6:00:00 AM	. Microsoft
	Corporation				
jscript.dll	5.1.0.5010	476 KB	7/26/2000	6:00:00 AM	
	C:\WINNT\system32 Microsoft Corporation				
jscript.dll	5.1.0.5010	476 KB	7/26/2000	6:00:00 AM	.
	Microsoft Corporation				
jsproxy.dll	5.0.2920.0	13 KB	7/26/2000	6:00:00 AM	C:\WINNT\system32
	Microsoft Corporation				
jsproxy.dll	5.0.2920.0	13 KB	7/26/2000	6:00:00 AM	. Microsoft
	Corporation				
msaahtml.dll	<File Missing>	Not Available	Not Available	Not Available	
	Not Available Not Available				
mshtml.dll	5.0.3103.1000	2292 KB	7/26/2000	6:00:00 AM	
	C:\WINNT\system32 Microsoft Corporation				
mshtml.dll	5.0.3103.1000	2292 KB	7/26/2000	6:00:00 AM	.
	Microsoft Corporation				
msjava.dll	5.0.3310.0	922 KB	7/26/2000	6:00:00 AM	
	C:\WINNT\system32 Microsoft Corporation				
msjava.dll	5.0.3310.0	922 KB	7/26/2000	6:00:00 AM	.
	Microsoft Corporation				
msoss.dll	<File Missing>	Not Available	Not Available	Not Available	Not
	Available Not Available				
msxml.dll	8.0.5226.0	506 KB	7/26/2000	6:00:00 AM	
	C:\WINNT\system32 Microsoft Corporation				
msxml.dll	8.0.5226.0	506 KB	7/26/2000	6:00:00 AM	.
	Microsoft Corporation				
occache.dll	5.0.3103.1000	86 KB	7/26/2000	6:00:00 AM	
	C:\WINNT\system32 Microsoft Corporation				
occache.dll	5.0.3103.1000	86 KB	7/26/2000	6:00:00 AM	.
	Microsoft Corporation				
ole32.dll	5.0.2195.1607	965 KB	7/26/2000	6:00:00 AM	
	C:\WINNT\system32 Microsoft Corporation				
ole32.dll	5.0.2195.1607	965 KB	7/26/2000	6:00:00 AM	.
	Microsoft Corporation				
oleaut32.dll	2.40.4514.1	600 KB	7/26/2000	6:00:00 AM	
	C:\WINNT\system32 Microsoft Corporation				

Appendix C – Tunable Parameters

oleaut32.dll	2.40.4514.1	600 KB	7/26/2000 6:00:00 AM	.
Microsoft Corporation				
olepro32.dll	5.0.4514.1	160 KB	7/26/2000 6:00:00 AM	
C:\WINNT\system32 Microsoft Corporation				
olepro32.dll	5.0.4514.1	160 KB	7/26/2000 6:00:00 AM	.
Microsoft Corporation				
rsabase.dll	5.0.2195.1391	129 KB	7/26/2000 6:00:00 AM	
C:\WINNT\system32 Microsoft Corporation				
rsabase.dll	5.0.2195.1391	129 KB	7/26/2000 6:00:00 AM	.
Microsoft Corporation				
rsaenh.dll	<File Missing>	Not Available	Not Available	Not
Available Not Available				
rsapi32.dll	<File Missing>	Not Available	Not Available	Not
Available Not Available				
rsasig.dll	<File Missing>	Not Available	Not Available	Not
Available Not Available				
schannel.dll	5.0.2195.0	137 KB	7/26/2000 6:00:00 AM	
C:\WINNT\system32 Microsoft Corporation				
schannel.dll	5.0.2195.0	137 KB	7/26/2000 6:00:00 AM	.
Microsoft Corporation				
shdoc401.dll	<File Missing>	Not Available	Not Available	
Not Available Not Available				
shdocvw.dll	5.0.3103.1000	1078 KB	7/26/2000 6:00:00 AM	
C:\WINNT\system32 Microsoft Corporation				
shdocvw.dll	5.0.3103.1000	1078 KB	7/26/2000 6:00:00 AM	.
Microsoft Corporation				
shell32.dll	5.0.3103.1000	2303 KB	7/26/2000 6:00:00 AM	
C:\WINNT\system32 Microsoft Corporation				
shell32.dll	5.0.3103.1000	2303 KB	7/26/2000 6:00:00 AM	.
Microsoft Corporation				
shlwapi.dll	5.0.3103.1000	282 KB	7/26/2000 6:00:00 AM	
C:\WINNT\system32 Microsoft Corporation				
shlwapi.dll	5.0.3103.1000	282 KB	7/26/2000 6:00:00 AM	.
Microsoft Corporation				
url.dll	5.0.2920.0	82 KB	7/26/2000 6:00:00 AM	C:\WINNT\system32
Microsoft Corporation				
url.dll	5.0.2920.0	82 KB	7/26/2000 6:00:00 AM	. Microsoft
Corporation				
urlmon.dll	5.0.3103.1000	441 KB	7/26/2000 6:00:00 AM	
C:\WINNT\system32 Microsoft Corporation				
urlmon.dll	5.0.3103.1000	441 KB	7/26/2000 6:00:00 AM	.
Microsoft Corporation				
vbscript.dll	5.1.0.5010	428 KB	7/26/2000 6:00:00 AM	
C:\WINNT\system32 Microsoft Corporation				
vbscript.dll	5.1.0.5010	428 KB	7/26/2000 6:00:00 AM	.
Microsoft Corporation				
webcheck.dll	5.0.3103.1000	252 KB	7/26/2000 6:00:00 AM	
C:\WINNT\system32 Microsoft Corporation				
webcheck.dll	5.0.3103.1000	252 KB	7/26/2000 6:00:00 AM	
Microsoft Corporation				
win.com	5.0.2134.1	24 KB	7/26/2000 6:00:00 AM	C:\WINNT\system32
Microsoft Corporation				
win.com	5.0.2134.1	24 KB	7/26/2000 6:00:00 AM	. Microsoft
Corporation				

Appendix C – Tunable Parameters

```
wininet.dll 5.0.3103.1000      457 KB      7/26/2000 6:00:00 AM
    C:\WINNT\system32 Microsoft Corporation
wininet.dll 5.0.3103.1000      457 KB      7/26/2000 6:00:00 AM      .
    Microsoft Corporation
winsock.dll 3.10.0.103   3 KB   7/26/2000 6:00:00 AM      C:\WINNT\system32
    Microsoft Corporation
winsock.dll 3.10.0.103   3 KB   7/26/2000 6:00:00 AM      .      Microsoft
Corporation
wintrust.dll      5.131.2143.1      162 KB      7/26/2000 6:00:00 AM
    C:\WINNT\system32 Microsoft Corporation
wintrust.dll      5.131.2143.1      162 KB      7/26/2000 6:00:00 AM
    .      Microsoft Corporation
wsock.vxd      <File Missing>      Not Available      Not Available      Not
Available      Not Available
wsock32.dll 5.0.2195.1207      21 KB 7/26/2000 6:00:00 AM
    C:\WINNT\system32 Microsoft Corporation
wsock32.dll 5.0.2195.1207      21 KB 7/26/2000 6:00:00 AM      .
    Microsoft Corporation
wsock32n.dll      <File Missing>      Not Available      Not Available
    Not Available      Not Available
```

[Connectivity]

```
Item Value
Connection Preference      Never dial
EnableHttp1.1      1
ProxyHttp1.1      0
```

LAN Settings

```
AutoConfigProxy      wininet.dll
AutoProxyDetectMode      Enabled
AutoConfigURL
Proxy Disabled
ProxyServer
ProxyOverride
```

[Cache]

[Following are sub-categories of this main category]

[Summary]

```
Item Value
Page Refresh Type Automatic
Temporary Internet Files Folder      C:\Documents and
Settings\Administrator\Local Settings\Temporary Internet Files
Total Disk Space      17359 MB
Available Disk Space      14767 MB
Maximum Cache Size      542 MB
Available Cache Size      542 MB
```

[List of Objects]

```
Program File      Status      CodeBase
```

Appendix C – Tunable Parameters

No cached object information available

[Content]

[Following are sub-categories of this main category]

[Summary]

Item Value

Content Advisor Disabled

[Personal Certificates]

Issued To	Issued By	Validity	Signature Algorithm
Administrator	Administrator	3/29/2002 to 3/5/2102	sha1RSA

[Other People Certificates]

Issued To	Issued By	Validity	Signature Algorithm
No other people certificate information available			

[Publishers]

Name

No publisher information available

[Security]

Zone Security Level

Local intranet Medium-low

Trusted sites Low

Internet Medium

Restricted sites High

Appendix C – Tunable Parameters

RTE Input Parameters

BenchCraft Configuration File

Profile: 5800_40_8_01
File Path: C:\benchcrf_421\5800_40_8_01.pro
Version: 1.0.1

Number of Engines: 10

Name: DRIVER2A
Description: RTE2A
Directory: c:\tpcclog\rte2a.log
Machine: RTE2A
Parameter Set: PARAM2
Index: 0
Seed: 98176
Configured Users: 5800
Pipe Name: DRIVER43501360
Connect Rate: 2000
Start Rate: 0
CLIENT_NURAND: 208
CPU: 0

Name: DRIVER2B
Description: RTE2B
Directory: c:\tpcclog\rte2b.log
Machine: RTE2B
Parameter Set: PARAM2
Index: 100000000
Seed: 98176
Configured Users: 5800
Pipe Name: DRIVER40641161
Connect Rate: 2000
Start Rate: 0
CLIENT_NURAND: 208
CPU: 0

Name: DRIVER3A
Description: RTE3A
Directory: c:\tpcclog\rte3a.log
Machine: RTE3A
Parameter Set: PARAM2
Index: 200000000
Seed: 98176
Configured Users: 5800
Pipe Name: DRIVER371721555
Connect Rate: 2000
Start Rate: 0
CLIENT_NURAND: 208
CPU: 0

Appendix C – Tunable Parameters

Name: DRIVER3B
Description: RTE3B
Directory: c:\tpcclog\rte3b.log
Machine: RTE3B
Parameter Set: PARAM2
Index: 300000000
Seed: 98176
Configured Users: 5800
Pipe Name: DRIVER341837462
Connect Rate: 2000
Start Rate: 0
CLIENT_NURAND: 208
CPU: 0

Name: DRIVER4A
Description: RTE4A
Directory: c:\tpcclog\rte4a.log
Machine: RTE4A
Parameter Set: PARAM2
Index: 400000000
Seed: 98176
Configured Users: 5800
Pipe Name: DRIVER311984373
Connect Rate: 2000
Start Rate: 0
CLIENT_NURAND: 208
CPU: 0

Name: DRIVER4B
Description: RTE4B
Directory: c:\tpcclog\rte4b.log
Machine: RTE4B
Parameter Set: PARAM2
Index: 500000000
Seed: 98176
Configured Users: 5800
Pipe Name: DRIVER282107740
Connect Rate: 2000
Start Rate: 0
CLIENT_NURAND: 208
CPU: 0

Name: DRIVER5A
Description: RTE5A
Directory: c:\tpcclog\rte5a.log
Machine: RTE5A
Parameter Set: PARAM2
Index: 600000000
Seed: 98176
Configured Users: 5800
Pipe Name: DRIVER252204459
Connect Rate: 2000
Start Rate: 0
CLIENT_NURAND: 208

Appendix C – Tunable Parameters

CPU: 0

Name: DRIVER5B
Description: RTE5B
Directory: c:\tpcclog\rte5b.log
Machine: RTE5B
Parameter Set: PARAM2
Index: 700000000
Seed: 98176
Configured Users: 5800
Pipe Name: DRIVER222420160
Connect Rate: 2000
Start Rate: 0
CLIENT_NURAND: 208
CPU: 0

Name: DRIVER6A
Description: RTE6A
Directory: c:\tpcclog\rte6a.log
Machine: RTE6A
Parameter Set: PARAM2
Index: 800000000
Seed: 98176
Configured Users: 5800
Pipe Name: DRIVER192556896
Connect Rate: 2000
Start Rate: 0
CLIENT_NURAND: 208
CPU: 0

Name: DRIVER6B
Description: RTE6B
Directory: c:\tpcclog\rte6b.log
Machine: RTE6B
Parameter Set: PARAM2
Index: 900000000
Seed: 98176
Configured Users: 5800
Pipe Name: DRIVER162653836
Connect Rate: 2000
Start Rate: 0
CLIENT_NURAND: 208
CPU: 0

Number of User groups: 40

Driver Engine: DRIVER2A
IIS Server: CLIENT1_1
SQL Server: PE6500
User: sa
Protocol: Html
w_id Range: 1 - 145
w_id Max Warehouse: 5800
Scale: Normal
User Count: 1450

Appendix C – Tunable Parameters

District id: 1
Scale Down: No

Driver Engine: DRIVER3A
IIS Server: CLIENT2_1
SQL Server: PE6500
User: sa
Protocol: Html
w_id Range: 146 - 290
w_id Max Warehouse: 5800
Scale: Normal
User Count: 1450
District id: 1
Scale Down: No

Driver Engine: DRIVER3A
IIS Server: CLIENT3_1
SQL Server: PE6500
User: sa
Protocol: Html
w_id Range: 291 - 435
w_id Max Warehouse: 5800
Scale: Normal
User Count: 1450
District id: 1
Scale Down: No

Driver Engine: DRIVER3A
IIS Server: CLIENT4_1
SQL Server: PE6500
User: sa
Protocol: Html
w_id Range: 436 - 580
w_id Max Warehouse: 5800
Scale: Normal
User Count: 1450
District id: 1
Scale Down: No

Driver Engine: DRIVER3B
IIS Server: CLIENT5_1
SQL Server: PE6500
User: sa
Protocol: Html
w_id Range: 581 - 725
w_id Max Warehouse: 5800
Scale: Normal
User Count: 1450
District id: 1
Scale Down: No

Driver Engine: DRIVER3B
IIS Server: CLIENT6_1
SQL Server: PE6500
User: sa

Appendix C – Tunable Parameters

Protocol: Html
w_id Range: 726 - 870
w_id Max Warehouse: 5800
Scale: Normal
User Count: 1450
District id: 1
Scale Down: No

Driver Engine: DRIVER3B
IIS Server: CLIENT7_1
SQL Server: PE6500
User: sa
Protocol: Html
w_id Range: 871 - 1015
w_id Max Warehouse: 5800
Scale: Normal
User Count: 1450
District id: 1
Scale Down: No

Driver Engine: DRIVER3B
IIS Server: CLIENT8_1
SQL Server: PE6500
User: sa
Protocol: Html
w_id Range: 1016 - 1160
w_id Max Warehouse: 5800
Scale: Normal
User Count: 1450
District id: 1
Scale Down: No

Driver Engine: DRIVER4A
IIS Server: client1_1
SQL Server: PE6500
User: sa
Protocol: Html
w_id Range: 1161 - 1305
w_id Max Warehouse: 5800
Scale: Normal
User Count: 1450
District id: 1
Scale Down: No

Driver Engine: DRIVER4A
IIS Server: client2_1
SQL Server: PE6500
User: sa
Protocol: Html
w_id Range: 1306 - 1450
w_id Max Warehouse: 5800
Scale: Normal
User Count: 1450
District id: 1
Scale Down: No

Appendix C – Tunable Parameters

Driver Engine: DRIVER4A
IIS Server: client3_1
SQL Server: PE6500
User: sa
Protocol: Html
w_id Range: 1451 - 1595
w_id Max Warehouse: 5800
Scale: Normal
User Count: 1450
District id: 1
Scale Down: No

Driver Engine: DRIVER2A
IIS Server: CLIENT2_1
SQL Server: PE6500
User: sa
Protocol: Html
w_id Range: 1596 - 1740
w_id Max Warehouse: 5800
Scale: Normal
User Count: 1450
District id: 1
Scale Down: No

Driver Engine: DRIVER4A
IIS Server: client4_1
SQL Server: PE6500
User: sa
Protocol: Html
w_id Range: 1741 - 1885
w_id Max Warehouse: 5800
Scale: Normal
User Count: 1450
District id: 1
Scale Down: No

Driver Engine: DRIVER4B
IIS Server: CLIENT5_1
SQL Server: PE6500
User: sa
Protocol: Html
w_id Range: 1886 - 2030
w_id Max Warehouse: 5800
Scale: Normal
User Count: 1450
District id: 1
Scale Down: No

Driver Engine: DRIVER4B
IIS Server: client6_1
SQL Server: PE6500
User: sa
Protocol: Html
w_id Range: 2031 - 2175

Appendix C – Tunable Parameters

w_id Max Warehouse: 5800
Scale: Normal
User Count: 1450
District id: 1
Scale Down: No

Driver Engine: DRIVER4B
IIS Server: CLIENT7_1
SQL Server: PE6500
User: sa
Protocol: Html
w_id Range: 2176 - 2320
w_id Max Warehouse: 5800
Scale: Normal
User Count: 1450
District id: 1
Scale Down: No

Driver Engine: DRIVER4B
IIS Server: CLIENT8_1
SQL Server: PE6500
User: sa
Protocol: Html
w_id Range: 2321 - 2465
w_id Max Warehouse: 5800
Scale: Normal
User Count: 1450
District id: 1
Scale Down: No

Driver Engine: DRIVER5A
IIS Server: CLIENT1_1
SQL Server: PE6500
User: sa
Protocol: Html
w_id Range: 2466 - 2610
w_id Max Warehouse: 5800
Scale: Normal
User Count: 1450
District id: 1
Scale Down: No

Driver Engine: DRIVER5A
IIS Server: CLIENT2_1
SQL Server: PE6500
User: sa
Protocol: Html
w_id Range: 2611 - 2755
w_id Max Warehouse: 5800
Scale: Normal
User Count: 1450
District id: 1
Scale Down: No

Driver Engine: DRIVER5A

Appendix C – Tunable Parameters

IIS Server: CLIENT3_1
SQL Server: PE6500
User: sa
Protocol: Html
w_id Range: 2756 - 2900
w_id Max Warehouse: 5800
Scale: Normal
User Count: 1450
District id: 1
Scale Down: No

Driver Engine: DRIVER5A
IIS Server: CLIENT4_1
SQL Server: PE6500
User: sa
Protocol: Html
w_id Range: 2901 - 3045
w_id Max Warehouse: 5800
Scale: Normal
User Count: 1450
District id: 1
Scale Down: No

Driver Engine: DRIVER5B
IIS Server: CLIENT5_1
SQL Server: PE6500
User: sa
Protocol: Html
w_id Range: 3046 - 3190
w_id Max Warehouse: 5800
Scale: Normal
User Count: 1450
District id: 1
Scale Down: No

Driver Engine: DRIVER2A
IIS Server: CLIENT3_1
SQL Server: PE6500
User: sa
Protocol: Html
w_id Range: 3191 - 3335
w_id Max Warehouse: 5800
Scale: Normal
User Count: 1450
District id: 1
Scale Down: No

Driver Engine: DRIVER5B
IIS Server: CLIENT6_1
SQL Server: PE6500
User: sa
Protocol: Html
w_id Range: 3336 - 3480
w_id Max Warehouse: 5800
Scale: Normal

Appendix C – Tunable Parameters

User Count: 1450
District id: 1
Scale Down: No

Driver Engine: DRIVER5B
IIS Server: CLIENT7_1
SQL Server: PE6500
User: sa
Protocol: Html
w_id Range: 3481 - 3625
w_id Max Warehouse: 5800
Scale: Normal
User Count: 1450
District id: 1
Scale Down: No

Driver Engine: DRIVER5B
IIS Server: CLIENT8_1
SQL Server: PE6500
User: sa
Protocol: Html
w_id Range: 3626 - 3770
w_id Max Warehouse: 5800
Scale: Normal
User Count: 1450
District id: 1
Scale Down: No

Driver Engine: DRIVER6A
IIS Server: CLIENT1_1
SQL Server: PE6500
User: sa
Protocol: Html
w_id Range: 3771 - 3915
w_id Max Warehouse: 5800
Scale: Normal
User Count: 1450
District id: 1
Scale Down: No

Driver Engine: DRIVER6A
IIS Server: CLIENT2_1
SQL Server: PE6500
User: sa
Protocol: Html
w_id Range: 3916 - 4060
w_id Max Warehouse: 5800
Scale: Normal
User Count: 1450
District id: 1
Scale Down: No

Driver Engine: DRIVER6A
IIS Server: CLIENT3_1
SQL Server: PE6500

Appendix C – Tunable Parameters

User: sa
Protocol: Html
w_id Range: 4061 - 4205
w_id Max Warehouse: 5800
Scale: Normal
User Count: 1450
District id: 1
Scale Down: No

Driver Engine: DRIVER6A
IIS Server: CLIENT4_1
SQL Server: PE6500
User: sa
Protocol: Html
w_id Range: 4206 - 4350
w_id Max Warehouse: 5800
Scale: Normal
User Count: 1450
District id: 1
Scale Down: No

Driver Engine: DRIVER6B
IIS Server: CLIENT5_1
SQL Server: PE6500
User: sa
Protocol: Html
w_id Range: 4351 - 4495
w_id Max Warehouse: 5800
Scale: Normal
User Count: 1450
District id: 1
Scale Down: No

Driver Engine: DRIVER6B
IIS Server: CLIENT6_1
SQL Server: PE6500
User: sa
Protocol: Html
w_id Range: 4496 - 4640
w_id Max Warehouse: 5800
Scale: Normal
User Count: 1450
District id: 1
Scale Down: No

Driver Engine: DRIVER6B
IIS Server: CLIENT7_1
SQL Server: PE6500
User: sa
Protocol: Html
w_id Range: 4641 - 4785
w_id Max Warehouse: 5800
Scale: Normal
User Count: 1450
District id: 1

Appendix C – Tunable Parameters

Scale Down: No

Driver Engine: DRIVER2A
IIS Server: CLIENT4_1
SQL Server: PE6500
User: sa
Protocol: Html
w_id Range: 4786 - 4930
w_id Max Warehouse: 5800
Scale: Normal
User Count: 1450
District id: 1
Scale Down: No

Driver Engine: DRIVER6B
IIS Server: CLIENT8_1
SQL Server: PE6500
User: sa
Protocol: Html
w_id Range: 4931 - 5075
w_id Max Warehouse: 5800
Scale: Normal
User Count: 1450
District id: 1
Scale Down: No

Driver Engine: DRIVER2B
IIS Server: CLIENT5_1
SQL Server: PE6500
User: sa
Protocol: Html
w_id Range: 5076 - 5220
w_id Max Warehouse: 5800
Scale: Normal
User Count: 1450
District id: 1
Scale Down: No

Driver Engine: DRIVER2B
IIS Server: CLIENT6_1
SQL Server: PE6500
User: sa
Protocol: Html
w_id Range: 5221 - 5365
w_id Max Warehouse: 5800
Scale: Normal
User Count: 1450
District id: 1
Scale Down: No

Driver Engine: DRIVER2B
IIS Server: CLIENT7_1
SQL Server: PE6500
User: sa
Protocol: Html

Appendix C – Tunable Parameters

w_id Range: 5366 - 5510
w_id Max Warehouse: 5800
Scale: Normal
User Count: 1450
District id: 1
Scale Down: No

Driver Engine: DRIVER2B
IIS Server: CLIENT8_1
SQL Server: PE6500
User: sa
Protocol: Html
w_id Range: 5511 - 5655
w_id Max Warehouse: 5800
Scale: Normal
User Count: 1450
District id: 1
Scale Down: No

Driver Engine: DRIVER3A
IIS Server: CLIENT1_1
SQL Server: PE6500
User: sa
Protocol: Html
w_id Range: 5656 - 5800
w_id Max Warehouse: 5800
Scale: Normal
User Count: 1450
District id: 1
Scale Down: No

Number of Parameter Sets: 2

PARAM2

Slightly tweaked parameter set

	Txn Weight	Think Time	Key Time	RT Delay	RT Delay	Menu Fence	Menu Delay
New Order	44.84		12.04	18.02	0.10	5.00	0.10
Payment	43.04		12.04	3.02	0.10	5.00	0.10
Delivery	4.04		5.04	2.02	0.10	5.00	0.10
Stock Level	4.04		5.04	2.02	0.10	20.00	0.10
Order Status	4.04		10.04	2.02	0.10	5.00	0.10

~Default

Default Parameter Set

	Txn Weight	Think Time	Key Time	RT Delay	RT Delay	Menu Fence	Menu Delay
New Order	10.00		12.05	18.01	0.10	5.00	0.10
Payment	10.00		12.05	3.01	0.10	5.00	0.10
Delivery	1.00		5.05	2.01	0.10	5.00	0.10
Stock Level	1.00		5.05	2.01	0.10	20.00	0.10
Order Status	1.00		10.05	2.01	0.10	5.00	0.10

Appendix D – Disk Storage

Appendix D – Disk Storage

TPC-C 60 Day Space Requirements						
Warehouses	6000				TpmC	71,586.49
Table	Rows	Data KB	Index KB	Extra 5% KB	8hr Space	Total Space KB
Warehouse	6000	648	48	35		731
District	60000	6672	64	337		7073
Customer	180000000	130909096	7806176	6,935,764		145651036
History	180000000	10000008	160		1,908,975	10000168
NewOrder	54000000	853760	1984			855744
Orders	180000000	5517248	2508952		1,053,228	8026200
OrderLine	1799998798	112499928	238136		21,475,933	112738064
Item	100000	9528	64	480		10072
Stock	600000000	192000008	358904	9,617,946		201976858
Total		451,796,896	10,914,488	16,554,560	24,438,136	479,265,944
MB						
Dynamic Space	125,017	Sum of Data for Order, Orderline and History				
Static Space	343,016	Sum of Data+Index+5%-Dynamic Space				
Free Space	na	Total Allocated Spac - (Dynamic + Static Space)				
Daily Growth	23,865	(Dynamic Space/(W*62.5))*tpmc				
Daily Spread	-	(Free Space -1.5*Daily Growth) Zero Assumed				
60 Day Space MB	1,774,938					
60 Day Space GB	1,733.34	GB				
Log Size	208,200	MB				
KB Per New Order	5.2447	KB				
8 hr log MB	175,991	MB				
8 hr log GB	171.8661	GB				
Space Usage	GB Needed	Disks Measured	GB Priced	Disk Size	Formatted Size	
60 Day Space DB	1,733.34	280	4692.13	18GB	16.758	
		0	0.00	9GB	8.195	
		0	0.00	4GB	3.999	
Total DB		280.00	4692.13	9GB		
8-hr log + mirror	343.7322	12	416.54	36GB	34.712	
OS, Swap	3	1	17.357	18GB		
Total Storage	2,080.07	GB	5,126.03	GB		

Appendix E – Price Quotations

Appendix E - Price Quotations

Mylex ExtremeRAID 2000 Quotation

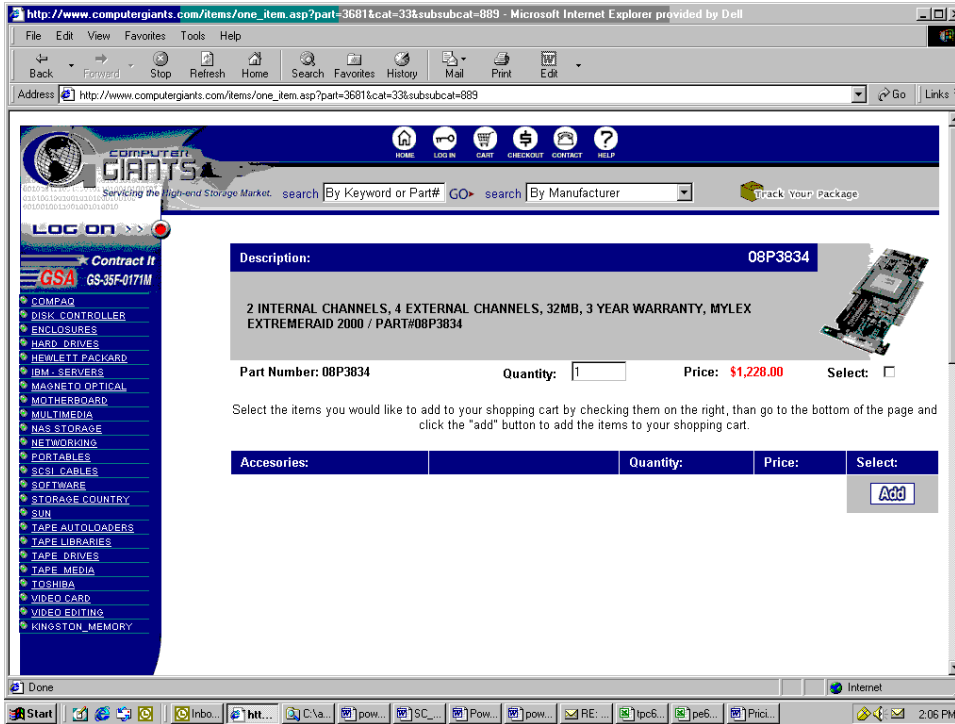

Appendix E – Price Quotations

Microsoft Corporation
One Microsoft Way
Redmond, WA 98052-6399

Tel 425 882 8080
Fax 425 936 7329
<http://www.microsoft.com/>

Microsoft

December 21, 2002

Dell Computer Corporation
Nicholas Wakou
RR5
One Dell Way
Round Rock, TX 78682

Mr. Wakou:

Here is the information you requested regarding pricing for several Microsoft products to be used in conjunction with your TPC-C benchmark testing.

All pricing shown is in US Dollars (\$).

Part Number	Description	Unit Price	Quantity	Price
810-00846	SQL Server 2000 Enterprise Edition <i>Per processor licensing Discount Schedule: Open Program Level C Unit Price reflects a 17% discount from the retail unit price of \$19,999.</i>	\$16,541	4	\$66,164
C11-00821	Windows 2000 Server <i>Server license only - No CALs Discount Schedule: Open Program - No Level Unit Price reflects a 8% discount from the retail unit price of \$799.</i>	\$738	8	\$5,904
N/A	Windows .Net 2003 Enterprise Server <i>Server license only - No CALs Discount Schedule: Open Program - No Level Unit Price reflects a 18% discount from the retail unit price of \$3,299.</i>	\$2,699	1	\$2,699
254-00170	Visual C++ .Net Standard <i>No discounts applied</i>	\$109	1	\$109
PRO-PRORS-16U-01	Database Server Support Package <i>1 Year Term</i>	\$1,950	3	\$5,850

Some products may not be currently orderable but will be available through Microsoft's normal distribution channels by February 28, 2003.

Prices for the Microsoft Windows .Net products are considered Not to Exceed pricing. Actual prices will be announced when the Microsoft .Net products are available.

This quote is valid for the next 90 days.

If we can be of any further assistance, please contact Jamie Reding at (425) 703-0510 or jamiere@microsoft.com.

Reference ID: PCniwa0221122053

Please include this Reference ID in any correspondence regarding this price quote.